



# Ersatzteile und Zubehör

für LKW- und Anhängerbeleuchtung

# Spare Parts and Accessories

for Trucks and Trailers Lighting





## ERSATZTEILE | ZUBEHÖR

Sie halten unsere ganze Vielfalt an Ersatzteilen für Truck & Trailer in Ihren Händen. Das Ersatzteilsortiment umfasst nicht nur ein umfangreiches Angebot an Leuchten und Lichtkomponenten, sondern auch die dazugehörigen Steckverbinder plus zahlreiche Zubehörartikel.

Unsere Ersatzteilproduktpalette für LKW- und Anhängerbeleuchtung zeichnet sich durch innovative Technik, gleichbleibend hochwertige Qualität und Funktionssicherheit aus. Mit diesen Merkmalen sind wir in den letzten 45 Jahren zu einem führenden Erstausrüster im Bereich Fahrzeugbeleuchtung geworden.

Sie haben jetzt die Qual der Wahl. Zur leichteren Orientierung oder für ein konkretes Angebot, wenden Sie sich gerne an unser Verkaufsteam.

## SPARE PARTS | ACCESSORIES

You carry our whole variety of spare parts for Truck & Trailer in your hands. The range of spare parts includes not only an extensive range of lamps and lighting components, but also the associated connectors plus numerous accessories.

Our range of spare parts for truck and trailer lighting is characterized by innovative technology, consistently high quality and functional reliability. These features have made us a leading original equipment manufacturer in the vehicle lighting sector over the past 45 years.

You are now spoiled for choice. For easier orientation or for a specific offer, please feel welcome to contact our sales team.





Heckleuchte  
Rear Lamp



Umrissleuchte  
End Outline Marker



Positionsleuchte  
Position Lamp

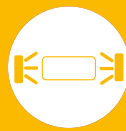

Kennzeichenleuchte  
Number Plate Lamp



Bremsleuchte  
Stop Lamp



Rückfahrleuchte  
Arbeitsscheinwerfer  
Reverse Lamp  
Working Lamp



Innenleuchte  
Interior Lamp



Verkabelungen &  
Verteiler  
Connections &  
Junction Boxes



Zubehör  
Accessories



Information

# LICHTANLAGE

## ZULEITUNGEN | FEED LINES

Seite 214

## POSITIONSLEUCHTEN | POSITION LAMPS

Seite 128

## HAUPTLEITUNG | MAIN CABLE

Seite 216

## VERTEILER | JUNCTION BOX

Seite 212

## VERTEILERLEITUNG | SUPPLY HARNESS

Seite 221

## SEITENMARKIERUNGSKONTROLLGERÄT | SIDE MARKER CONTROL GEAR

Seite 234

## UMRISSLEUCHTEN | END-OUTLINE MARKER LAMPS

Seite 108

## HECKLEUCHTEN | REAR LAMPS

Seite 12

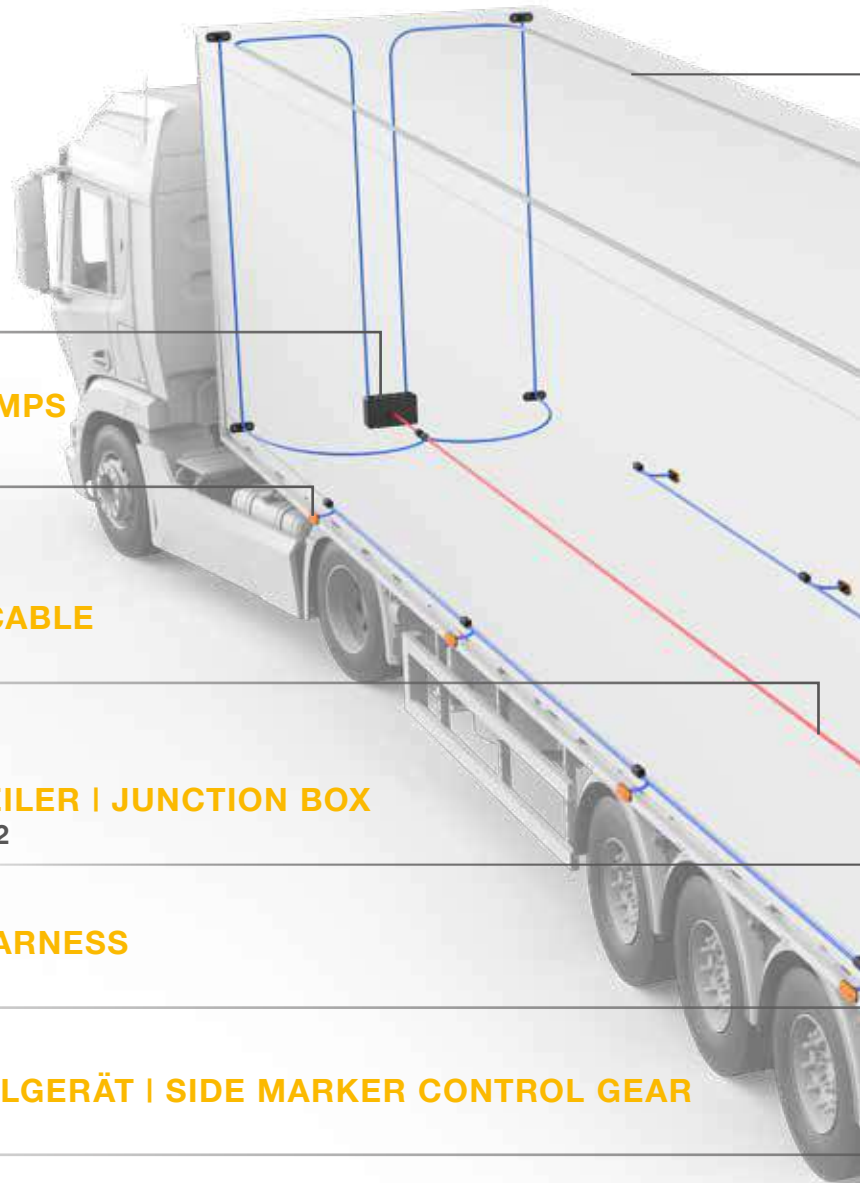

# LIGHT SYSTEM

**INNENBELEUCHTUNG | INTERIOR LAMPS**  
Seite 202

**DRITTE BREMSLEUCHE | THIRD STOP LAMP**  
Seite 178

**SML VERSORGUNG | SML SUPPLY**  
Seite 220

**UNTERFAHRSCHUTZ |  
UNDERRUN PROTECTION**  
Seite 239

**KENNZEICHENBELEUCHTUNG | NUMBER PLATE LAMPS**  
Seite 164

**ARBEITS- & RÜCKFAHRSCHEINWERFER |  
WORK & REVERSING LAMPS**  
Seite 182

# INHALT / CONTENT

## HECKLEUCHTE

### REAR LAMP

14	ECOLED III	
16	ECOLED II	
20	ECOLED	
22	EUROPOINT III	
29	EUROPOINT II	
35	EUROPOINT I	
37	ECOPOINT II	
43	ECOPOINT I	
49	ECOFLEX	
52	EUROFAB	
54	MIDILED I	
56	MIDILED I MAX	
58	EARPOINT LED	
60	EARPOINT I	
62	MULTILED IV	
64	MULTILED III	
67	MULTILED II	
71	MULTILED	

73	MULTIPOINT V	
75	MULTIPOINT LED	
77	MINILED II	
79	LINEPOINT II	
81	LINEPOINT I	
83	POSIPOINT IV	
85	BRASPOINT 98	
88	BRASPOINT 140	
90	ROUNDPOINT II	
91	ROUNDPOINT II LED	
92	3 CHAMBER LAMP II LED	
95	3 CHAMBER LAMP I LED	
96	3 CHAMBER LAMP	
100	AGRILED I	
102	AGRILED II	
104	AGRIPOINT	
106	MINILED III	

## UMRISSLEUCHE

### END OUTLINE MARKER

110	SUPERPOINT IV LED	
-----	-------------------	---

115 SUPERPOINT III LED



119 SUPERPOINT II



122 FLEXIPOINT II LED



124 FLEXIPOINT I LED



126 FLEXIPOINT I



## POSITIONSLEUCHE

### POSITION LAMP

130 FLATPOINT II LED



134 FLATPOINT I LED



138 UNIPOINT II LED



140 UNIPOINT I LED



146 UNIPOINT DI



148 UNIPOINT DI + SML



150 UNIPOINT MAXX LED



152 SIDEPOINT



155 POSIPOINT II LED



157 POSIPOINT I LED



159 MONOPOINT II LED



162 MONOPOINT I LED



## KENNZEICHENLEUCHE

### NUMBER PLATE LAMP

166 NUMBER PLATE  
HOLDER FLEXLED



168 REGPOINT II LED



170 REGPOINT LED



172 REGPOINT



## BREMSLEUCHE

### STOP LAMP

180 DRITE  
BREMSLEUCHE /  
THIRD STOP LAMP



## RÜCKFAHRLEUCHE ARBEITSSCHEINWERFER REVERSE LAMP WORKING LAMP

184 WORKPOINT II 1000



185 WORKPOINT II 1500



186 WORKPOINT II 3000



189 WORKPOINT LED 1500



192 WORKPOINT LED 3000



194 RÜCKFAHRSCHEIN-  
WERFER LED /  
REVERSE LAMP LED



196 WORKPOINT LED 800



198 WORKPOINT LED 650



200 RÜCKFAHRSCHEIN-  
WERFER /  
REVERSE LAMP



## INNENLEUCHE

### INTERIOR LAMP

204 INPOINT III LED



206 INTERIOR LAMP  
LED ROUND



207 INTERIOR LAMP LED



208 TUBEPOINT LED



## VERKABELUNGEN AND VERTEILER WIRING AND JUNCTION BOXES

212 STECKDOSEN-  
VERTEILER  
SOCKET JUNCTION



214 ZULEITUNGEN  
FEED LINES



216 HAUPTKABEL  
MAIN CABLES



217 VERTEILERBOX ASS1  
JUNCTION BOX ASS1



219 VERTEILERBOX XL  
JUNCTION BOX XL



220 VERKABELUNGEN SML  
SML WIRING



221 VERTEILERLEITUNG  
HINTEN  
REAR SUPPLY  
HARNESS



222 ADAPTERKABEL  
ADAPTER CABLES



225 VERLÄNGERUNGS-  
KABEL  
EXTENSION CABLE

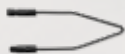

## ZUBEHÖR

## ACCESSORIES

228 RADC 1.0



230 RDC PREMIUM - KIT



233 RÜCKFAHRWAHRNER/  
BEEPER



234 SMCG



235 EDR



236 SMARTLINK -  
SUPERSEAL



238 VERBREITERUNG /  
EXPANSION



239 UNTERFAHRSCHUTZ /  
UNDERRUN  
PROTECTION



241 LCG



244 VERBINDER /  
CONNECTORS



## ZUSÄTZLICHE INFORMATION

## ADDITIONAL INFORMATION

248 STANDARD-  
STECKPLAN  
PLUG IN-  
DIAGRAMM



250 E-NUMMERN  
ÜBERSICHT  
APPROVAL NUMBER  
OVERVIEW



252 ARTIKELNUMMERN  
PART NUMBERS

XX-XXXX-XXX

257 PIKTOGRAMM  
ÜBERSICHT /  
PICTOGRAM  
OVERVIEW







## WORKPOINT II 3000

- >> Vertikaler Drehbereich: -66° to +126° | Vertical rotation range: -66° to +126°
- >> Platzsparendes Design | Space-saving design



## WORKPOINT II 1000

- >> Vertikaler Drehbereich: -40° to +110°  
Vertical rotation range: -40° to +110°



## WORKPOINT II 1500

- >> Vertikaler Drehbereich: -35° to +100°  
Vertical rotation range: -35° to +100°

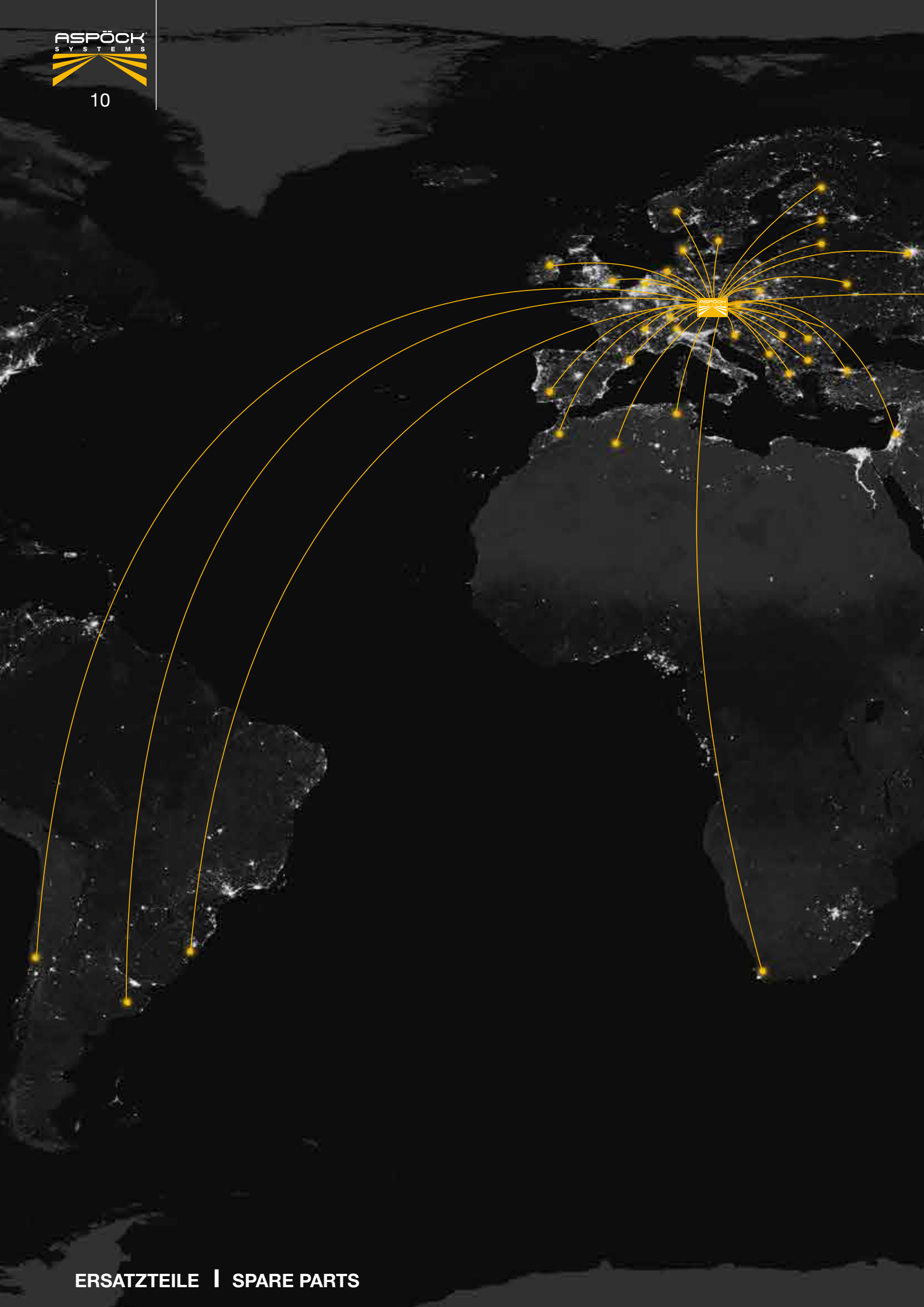

## ASPÖCK SYSTEMS - MEHR ALS 45 JAHRE LICHTMACHER

Die „große Idee“ begann im Kleinen und führte zu internationalem Erfolg. Mit dem Vorhaben, die Beleuchtung von Fahrzeugen zu revolutionieren, verschraubte der Tüftler Felix Aspöck 1977 das erste Beleuchtungssystem in seiner privaten Kellerwerkstatt. Er ebnete damit den Weg in Richtung Weltkonzern.

Heute – über 45 Jahre später – ist es fast unmöglich, auf den Straßen keinem Lichtsystem von Aspöck zu begegnen, denn unser Marktanteil liegt bereits bei 65 Prozent am europäischen PKW- und LKW-Anhängermarkt. Wir produzieren erfolgreich anspruchsvolle Lichtlösungen, deren Basis noch immer das Komplettsystem einer Lichtenanlage ist.

## ASPÖCK SYSTEMS – MAKING LIGHTS FOR OVER 45 YEARS

The “big idea” started on a small scale and led to international success. With the intention of revolutionizing vehicle lighting, inventor Felix Aspöck screwed together the first lighting system in his private basement workshop in 1977. In doing so, he paved the way towards becoming a global company.

Today – over 45 years later – it is almost impossible not to see an Aspöck lighting system on the road, as we have a 65 percent share of the European car and truck trailer market. We produce sophisticated lighting solutions, still based on the all-in-one system of a lighting installation.



Standorte & Vertriebsnetz  
Sites & Sales network

# Falck® TEMS



## HECKLEUCHE

Tragen Ihre Fahrzeuge bereits „Aspöck“ am Heck?

Mit unseren unterschiedlichen Heckleuchten ermöglichen wir eine große Vielfalt – von einer klassischen Lichtlösung bis hin zu einem markentypischen Erscheinungsbild – in neuester LED-Technologie. Je nach Bedarf sind verschiedene Funktionen integriert, welche von Ein-, Zwei- bis Mehrfunktionsleuchten reichen. Sie bieten Ihnen als Aspöck-Komplettsystem zahlreiche Vorteile.

## REAR LAMP

Do your vehicles already wear „Aspöck“ at the rear?

With our different rear lamps, we enable a wide variety – from a classic lighting solution to a brand-typical appearance – in the latest LED technology. Depending on requirements, various functions are integrated which extend from single-, dual- and multi-function lamps. They offer you numerous benefits in the Aspöck all-in-one system.

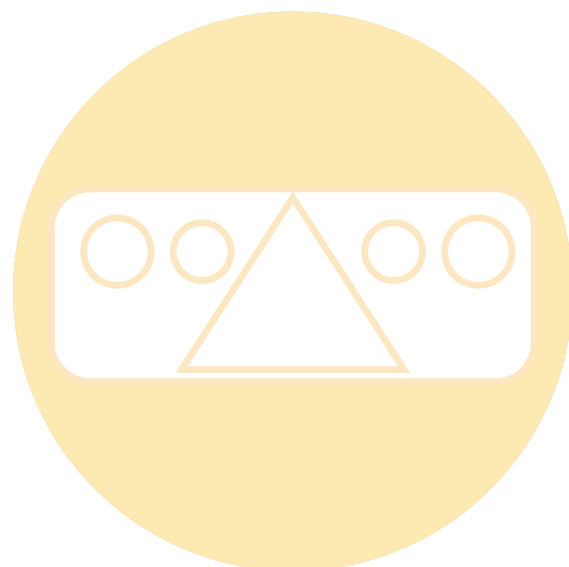



# ECOLED III

ISO 13207-1 ADR Zone 2 IP 6K9K



Produktinformation  
Product information

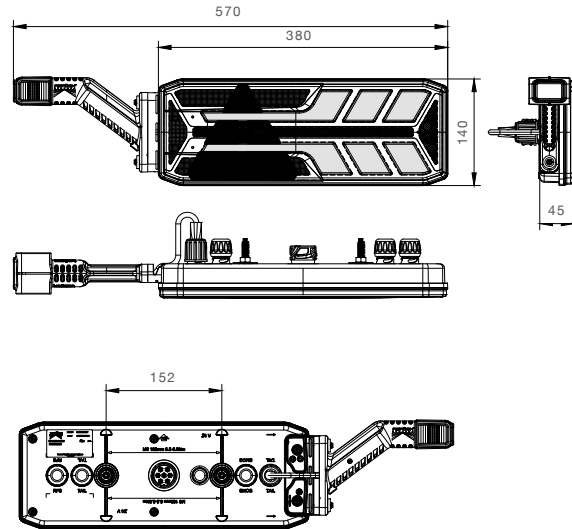

Dynamischer Blinker Progressive direction indicator	Rücklicht Tail light	Bremslicht Stop light	Nebelschlusslicht Fog light
Rückfahrlicht Reverse light	Dreieckrückstrahler Triangle reflector		

BEST. NR PART NO							ZUSATZ ADD ON	ANSCHLUSS CONNECTOR					
25-4122-011	1/-	●		LED	24V			7 pol. ASS2.1 7 pin ASS2.1					
25-4122-021	1/-	●		LED	24V			7 pol. ASS2.1 7 pin ASS2.1				4 x 2 pol. ASS2 4 x 2 pin ASS2	
25-4122-031	1/-	●		LED	24V	LED		7 pol. ASS2.1 7 pin ASS2.1				4 x 2 pol. ASS2 4 x 2 pin ASS2	
25-4122-041	1/-	●		LED	24V			7 pol. AMP 7 pin AMP					
25-4122-051	1/-	●		LED	24V			7 pol. AMP 7 pin AMP				4 x 2 pol. ASS2 4 x 2 pin ASS2	
25-4122-061	1/-	●		LED	24V	LED		7 pol. AMP 7 pin AMP				4 x 2 pol. ASS2 4 x 2 pin ASS2	
25-4123-011	1/-		●	LED	24V			7 pol. ASS2.1 7 pin ASS2.1					
25-4123-021	1/-		●	LED	24V			7 pol. ASS2.1 7 pin ASS2.1				4 x 2 pol. ASS2 4 x 2 pin ASS2	
25-4123-031	1/-		●	LED	24V	LED		7 pol. ASS2.1 7 pin ASS2.1				4 x 2 pol. ASS2 4 x 2 pin ASS2	
25-4123-041	1/-		●	LED	24V			7 pol. AMP 7 pin AMP					
25-4123-051	1/-		●	LED	24V			7 pol. AMP 7 pin AMP				4 x 2 pol. ASS2 4 x 2 pin ASS2	
25-4123-061	1/-		●	LED	24V	LED		7 pol. AMP 7 pin AMP				4 x 2 pol. ASS2 4 x 2 pin ASS2	



ECOLED III

ZUBEHÖR / ACCESSORIES

ISO  
13207-1

ADR  
Zone 2

IP 6K9K



- 1 ASS2 Verbinder | ASS2 connector**  
 7 pol. weiblich  
 7 pin. female ..... 13-5626-631   
 7 pol. männlich  
 7 pin. male ..... 13-5625-981 

- 4 Halterung und Schrauben  
Bracket and screws**  
 (a) 2 pol. weiblich  
 2 pin female ..... 15-5300-294 

- 2 AMP Verbinder | AMP connector**  
 7 pol. weiblich  
 7 pin female ..... 15-7002-024   
 7 pol. männlich  
 7 pin male ..... 15-7002-034 

- 3 Umrißarm LED inkl. Haltewinkel und Schrauben  
end outline marker LED incl. bracket and screws**  
 (a) ASS2 links 12V / 24V  
 ASS2 left 12V / 24V ..... 31-3102-204   
 ASS2 rechts 12V / 24V  
 ASS2 right 12V / 24V ..... 31-3103-204   
 (b) Superseal links 12V / 24V  
 Superseal left 12V / 24V .. 31-3102-214   
 Superseal rechts 12V / 24V  
 Superseal right 12V / 24V 31-3103-214 

# THE ART OF LIGHTS

## ECOLED III

SMCG inkludiert | *SMCG included*  
Dynamischer Fahrtrichtungsanzeiger | *Progressive direction indicator*



## ECOLED II

Glowing Body Technologie | *Glowing body technology*  
Beidseitig verwendbar | *Can be used on both sides*







# ECOLED II



EcoLED II  
Video  
EcoLED II  
video

Produktinformation  
Product information

ISO  
13207-1

ADR  
Zone 2

IP 54

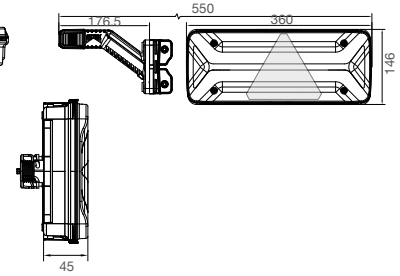
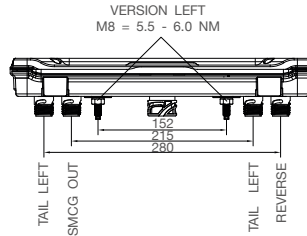

Dynamischer Blinker Progressive direction indicator	Rücklicht Tail light	Bremslicht Stop light	Nebelschlusslicht Fog light
Rückfahrlicht Reverse light	Dreieckrückstrahler Triangle reflector		

BEST. NR	PART NO							ZUSATZ ADD ON	ANSCHLUSS CONNECTOR
25-4121-001	1/8	●			12V 24V			7 pol. ASS2.1 7 pin ASS2.1	
25-4121-011	1/8	●			12V 24V			7 pol. ASS2.1 7 pin ASS2.1	4 x 2 pol. ASS2 4 x 2 pin ASS2
25-4121-021	1/8	●			12V 24V			7 pol. ASS2.1 7 pin ASS2.1	4 x 2 pol. ASS2 4 x 2 pin ASS2
25-4121-031	1/8	●			12V 24V			7 pol. AMP 7 pin AMP	
25-4121-041	1/8	●			12V 24V			7 pol. AMP 7 pin AMP	4 x 2 pol. Superseal 4 x 2 pin Superseal
25-4121-051	1/8	●			12V 24V			7 pol. AMP 7 pin AMP	4 x 2 pol. Superseal 4 x 2 pin Superseal
25-4120-001	1/8		●		12V 24V			7 pol. ASS2.1 7 pin ASS2.1	
25-4120-011	1/8		●		12V 24V			7 pol. ASS2.1 7 pin ASS2.1	4 x 2 pol. ASS2 4 x 2 pin ASS2
25-4120-021	1/8		●		12V 24V			7 pol. ASS2.1 7 pin ASS2.1	4 x 2 pol. ASS2 4 x 2 pin ASS2
25-4120-031	1/8		●		12V 24V			7 pol. AMP 7 pin AMP	
25-4120-041	1/8		●		12V 24V			7 pol. AMP 7 pin AMP	4 x 2 pol. Superseal 4 x 2 pin Superseal
25-4120-051	1/8		●		12V 24V			7 pol. AMP 7 pin AMP	4 x 2 pol. Superseal 4 x 2 pin Superseal







ECOLED II Truck Version 



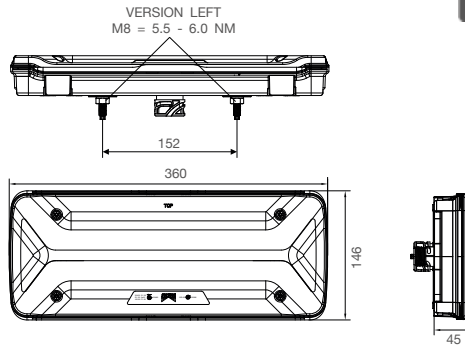









ISO  
13207-1

ADR  
Zone 2 

IP 54



 Blinklicht Direction indicator	 Rücklicht Tail light	 Bremslicht Stop light	 Nebelschlusslicht Fog light
 Rückfahrlicht Reverse light			

BEST. NR							ZUSATZ ADD ON	ANSCHLUSS CONNECTOR
25-4121-061	1/8	●		LED	12V 24V			7 pol. AMP 7 pin AMP   
25-4120-061	1/8		●	LED	12V 24V			7 pol. AMP 7 pin AMP   



ECOLED II

ZUBEHÖR / ACCESSORIES

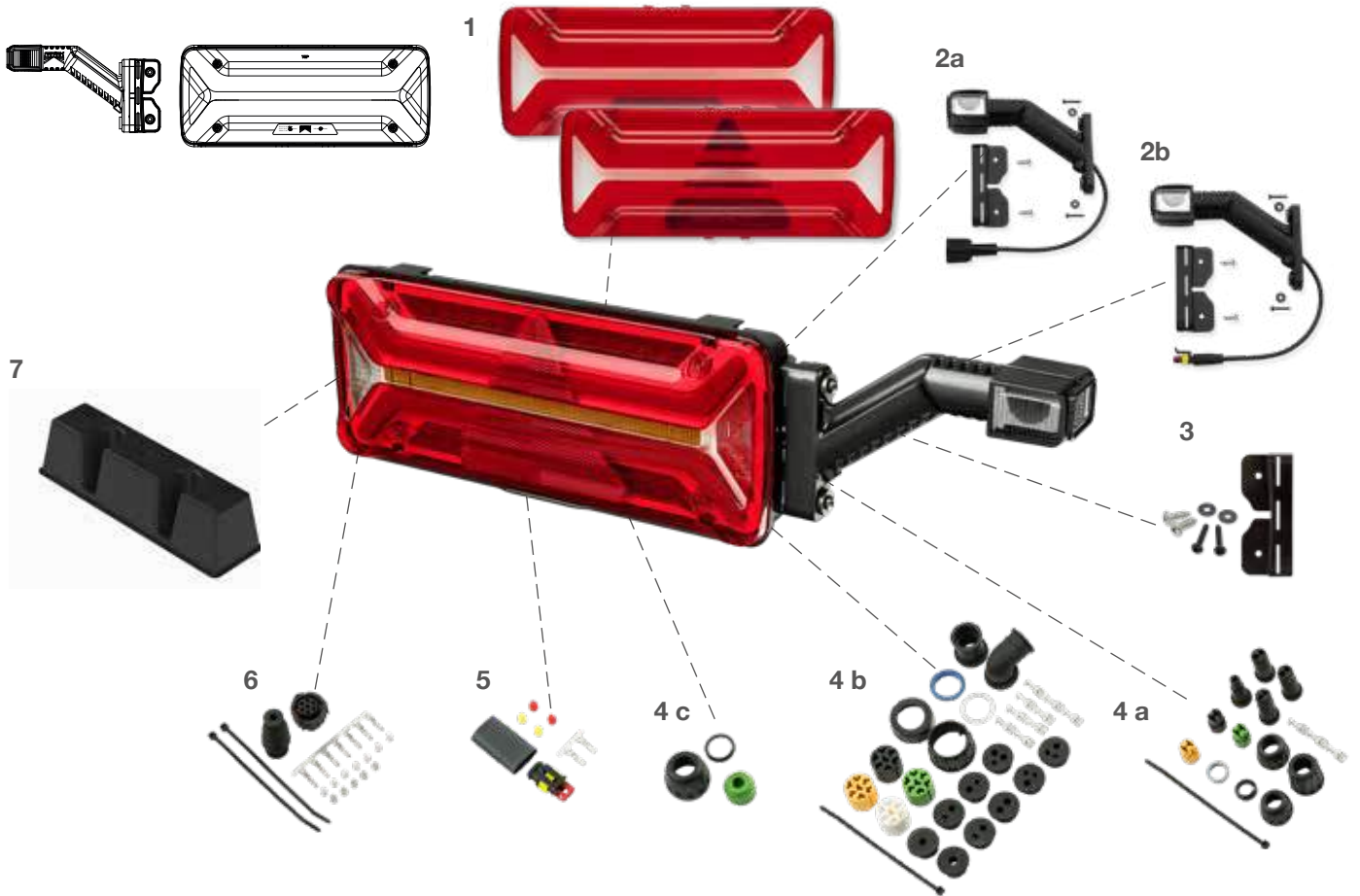



- 1** **Lichtscheibe | lens**  
mit Dreieck  
with triangle ..... 18-8536-001   
ohne Dreieck  
without triangle ..... 18-8536-011 

- 2** **Umrißarm LED inkl. Haltewinkel und Schrauben  
end outline marker LED incl. bracket and screws**  
(a) ASS2 links 12V / 24V  
ASS2 left 12V / 24V ..... 31-3103-204   
ASS2 rechts 12V / 24V  
ASS2 right 12V / 24V ..... 31-3102-204   
(b) Superseal links 12V / 24V  
Superseal left 12V / 24V .. 31-3103-214   
Superseal rechts 12V / 24V  
Superseal right 12V / 24V 31-3102-214 

- 3** **Haltewinkel + Schrauben | bracket + screws**  
..... 15-5300-294 

- 4** **ASS1 & ASS2 Verbinder |  
ASS1 & ASS2 connector**  
(a) 2 pol. weiblich  
2 pin female ..... 13-5626-401   
(b) 7 pol. weiblich  
7 pin female ..... 13-5626-631   
(c) Verschlusskappe  
closed connection ..... 15-5623-304 

- 5** **Superseal Verbinder |  
Superseal connector**  
2 pol. weiblich  
2 pin female ..... 15-7002-044 

- 6** **AMP Verbinder |  
AMP connector**  
7 pol. weiblich  
7 pin female ..... 15-7002-024 

- 7** **Schutzhaube | protection cap**  
..... 25-7537-154 



ECOLED

ADR Zone 2 IP69K



Produktinformation  
Product information

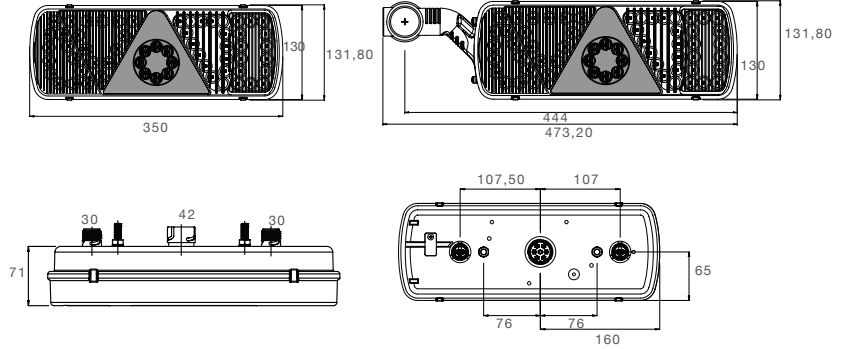

Blinklicht Direction indicator	Rücklicht Tail light	Bremslicht Stop light	Nebelschlusslicht Fog light
Rückfahrlicht Reverse light	Dreieckrückstrahler Triangle reflector	Seitenmarkierungslicht + Reflektor Sidemarker light + reflector	

BEST. NR	PART NO	←	→	LED	24V	LED	ZUSATZ ADD ON	ANSCHLUSS CONNECTOR
25-3800-501	1/10	●		LED	24V			7 pol. ASS2 7 pin ASS2
25-3800-511	1/6	●		LED	24V			7 pol. ASS2.1 7 pin ASS2.1
25-3820-511	1/8	●		LED	24V	LED		7 pol. ASS2.1 7 pin ASS2.1
25-3900-501	1/10		●	LED	24V			7 pol. ASS2 7 pin ASS2
25-3900-511	1/6		●	LED	24V			7 pol. ASS2.1 7 pin ASS2.1
25-3920-511	1/8		●	LED	24V	LED		7 pol. ASS2.1 7 pin ASS2.1



ECOLED

ZUBEHÖR / ACCESSORIES



**1** Umrissarm LED | outline marker LED

- rot / weiß / orange links  
red / white / orange left  
..... 31-3305-234 
- rot / weiß / orange rechts  
red / white / orange right  
..... 31-3306-234 

**2** Schutzhaube | protection cap

- ..... 15-5277-004 

**3** ASS1 & ASS2 Verbinder |  
ASS1 & ASS2 connector

- (a) 2 pol. weiblich  
2 pin female ..... 13-5626-401 
- (b) 7 pol. weiblich  
7 pin female ..... 13-5626-631 
- (c) Verschlusskappe  
closed connection ..... 15-5623-304 

**4** LED Vorschaltgerät | LED control gear

- ..... 75-0309-001 
- siehe Seite 166  
see at page 166



## EUROPOINT III links left

ADR Zone 2 IP56K



Produktinformation  
Product information



Europoint III  
Video  
Europoint III  
video

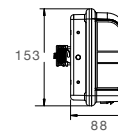
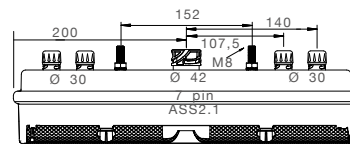
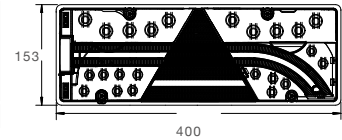
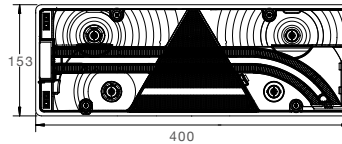

Blinklicht Direction indicator	Rücklicht Tail light	Bremslicht Stop light	Nebelschlusslicht Fog light
Rückfahrlicht Reverse light	Dreieckrückstrahler Triangle reflector	Seitenmarkierungslicht + Reflektor Sidemarker light + reflector	

BEST. NR	PART NO	Box	←	→	LED	24V	ZUSATZ ADD ON	ANSCHLUSS CONNECTOR
25-7000-501	1/10	●				24V		7 pol. ASS2.1 7 pin ASS2.1 ♂
25-7000-511	1/10	●				24V		7 pol. ASS2.1 7 pin ASS2.1 ♂ 4 x 2 pol. ASS2 4 x 2 pin ASS2
25-7000-701	1/10	●				24V		7 pol. ASS2.1 7 pin ASS2.1 ♂
25-7000-711	1/10	●				24V		7 pol. ASS2.1 7 pin ASS2.1 ♂ 4 x 2 pol. ASS2 4 x 2 pin ASS2
25-7000-721	1/10	●				24V		7 pol. ASS2.1 7 pin ASS2.1 ♂
25-7000-741	1/10	●				24V		7 pol. ASS2.1 7 pin ASS2.1 ♂
25-7030-721	1/10	●				24V		7 pol. AMP 7 pin AMP ♂ 4 x 2 pol. Superseal 4 x 2 pin Superseal
25-7001-501	1/6	●				24V		7 pol. ASS2.1 7 pin ASS2.1 ♂
25-7001-601	1/10	●				24V		7 pol. ASS2.1 7 pin ASS2.1 ♂ 4 x 2 pol. ASS2 4 x 2 pin ASS2
25-7030-711	1/10	●				24V		7 pol. AMP 7 pin AMP ♂ 4 x 2 pol. Superseal 4 x 2 pin Superseal
25-7001-611	1/10	●				24V		7 pol. ASS2.1 7 pin ASS2.1 ♂ 4 x 2 pol. ASS2 4 x 2 pin ASS2
25-7002-001	1/10	●				24V		7 pol. ASS2.1 7 pin ASS2.1 ♂ 4 x 2 pol. ASS2 4 x 2 pin ASS2
25-7000-761	1/10	●				24V		7 pol. ASS2.1 7 pin ASS2.1 ♂ 4 x 2 pol. ASS2 4 x 2 pin ASS2



EUROPOINT III rechts  
right

ADR Zone 2 IP56K

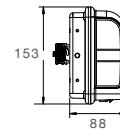
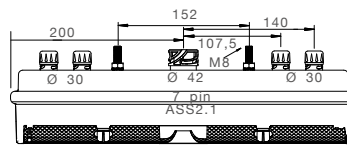
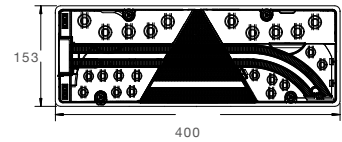
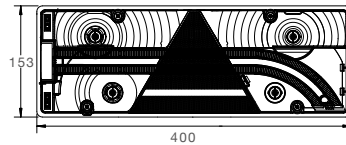

Blinklicht Direction indicator	Rücklicht Tail light	Bremslicht Stop light	Nebelschlusslicht Fog light
Rückfahrlicht Reverse light	Dreieckrückstrahler Triangle reflector	Seitenmarkierungslicht + Reflektor Sidemarker light + reflector	

BEST. NR PART NO							ZUSATZ ADD ON	ANSCHLUSS CONNECTOR			
25-7430-721	1/10		●	LED	24V			7 pol. AMP 7 pin AMP	♂	4 x 2 pol. Superseal 4 x 2 pin Superseal	
25-7400-501	1/10		●	LED	24V			7 pol. ASS2.1 7 pin ASS2.1	♂		
25-7400-511	1/10		●	LED	24V			7 pol. ASS2.1 7 pin ASS2.1	♂	4 x 2 pol. ASS2 4 x 2 pin ASS2	
25-7400-701	1/10		●	LED	24V			7 pol. ASS2.1 7 pin ASS2.1	♂		
25-7400-711	1/10		●	LED	24V			7 pol. ASS2.1 7 pin ASS2.1	♂	4 x 2 pol. ASS2 4 x 2 pin ASS2	
25-7400-721	1/10		●	LED	24V			7 pol. ASS2.1 7 pin ASS2.1	♂		
25-7400-741	1/10		●	LED	24V			7 pol. ASS2.1 7 pin ASS2.1	♂		
25-7401-531	1/10		●	LED	24V			7 pol. ASS2.1 7 pin ASS2.1	♂		
25-7401-601	1/6		●	LED	24V			7 pol. ASS2.1 7 pin ASS2.1	♂	4 x 2 pol. ASS2 4 x 2 pin ASS2	
25-7430-711	1/10		●	LED	24V			7 pol. AMP 7 pin AMP	♂	4 x 2 pol. Superseal 4 x 2 pin Superseal	
25-7401-611	1/10		●	LED	24V			7 pol. ASS2.1 7 pin ASS2.1	♂	4 x 2 pol. ASS2 4 x 2 pin ASS2	
25-7402-001	1/10		●	LED	24V			7 pol. ASS2.1 7 pin ASS2.1	♂	4 x 2 pol. ASS2 4 x 2 pin ASS2	
25-7400-761	1/10		●	LED	24V			7 pol. ASS2.1 7 pin ASS2.1	♂	4 x 2 pol. ASS2 4 x 2 pin ASS2	



**EUROPOINT III** links mit Umrissarm  
left with end outline marker

ADR Zone 2 IP56K

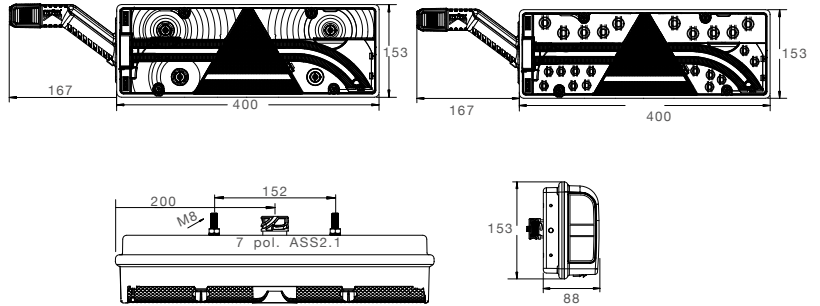

Blinklicht Direction indicator	Rücklicht Tail light	Bremslicht Stop light	Nebelschlusslicht Fog light
Rückfahrt Reverse light	Dreieckrückstrahler Triangle reflector	Seitenmarkierungslicht + Reflektor Sidemarker light + reflector	

BEST. NR	PART NO	Box	←	→	LED	24V	LED	ZUSATZ	ANSCHLUSS
								ADD ON	CONNECTOR
25-7020-501	1/6	●			LED	24V	LED		7 pol. ASS2.1 7 pin ASS2.1 ♂
25-7020-511	1/6	●			LED	24V	LED		7 pol. ASS2.1 7 pin ASS2.1 ♂ 4 x 2 pol. ASS2 4 x 2 pin ASS2
25-7020-541	1/6	●			LED	24V	LED		7 pol. ASS2.1 7 pin ASS2.1 ♂
25-7020-701	1/6	●			LED	24V	LED		7 pol. ASS2.1 7 pin ASS2.1 ♂
25-7020-711	1/6	●			LED	24V	LED		7 pol. ASS2.1 7 pin ASS2.1 ♂ 4 x 2 pol. ASS2 4 x 2 pin ASS2
25-7020-721	1/6	●			LED	24V	LED		7 pol. ASS2.1 7 pin ASS2.1 ♂
25-7020-731	1/8	●			LED	24V	LED		7 pol. ASS2.1 7 pin ASS2.1 ♂
25-7021-511	1/6	●			LED	24V	LED		7 pol. ASS2.1 7 pin ASS2.1 ♂ 4 x 2 pol. ASS2 4 x 2 pin ASS2
25-7002-101	1/6	●			LED	24V	LED		7 pol. ASS2.1 7 pin ASS2.1 ♂ 4 x 2 pol. ASS2 4 x 2 pin ASS2
25-7020-741	1/6	●			LED	24V	LED		7 pol. ASS2.1 7 pin ASS2.1 ♂ 4 x 2 pol. ASS2 4 x 2 pin ASS2
25-7020-751	1/6	●			LED	24V	LED		7 pol. ASS2.1 7 pin ASS2.1 ♂ 4 x 2 pol. ASS2 4 x 2 pin ASS2
25-7021-521	1/6	●			LED	24V	LED		7 pol. ASS2.1 7 pin ASS2.1 ♂ 4 x 2 pol. ASS2 4 x 2 pin ASS2





**EUROPOINT III** rechts mit Umrissarm  
right with end outline marker

ADR Zone 2 IP56K

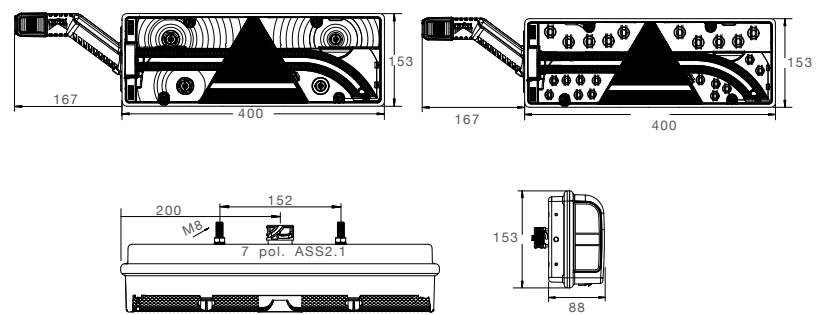

Blinklicht Direction indicator	Rücklicht Tail light	Bremslicht Stop light	Nebelschlusslicht Fog light
Rückfahrlicht Reverse light	Dreieckrückstrahler Triangle reflector	Seitenmarkierungslicht + Reflektor Sidemarker light + reflector	

BEST. NR PART NO		←	→				ZUSATZ ADD ON	ANSCHLUSS CONNECTOR
25-7420-501	1/6		●	LED	24V	LED		7 pol. ASS2.1 7 pin ASS2.1 ♂
25-7420-511	1/6		●	LED	24V	LED		7 pol. ASS2.1 7 pin ASS2.1 ♂ 4 x 2 pol. ASS2 4 x 2 pin ASS2
25-7420-541	1/6		●	LED	24V	LED		7 pol. ASS2.1 7 pin ASS2.1 ♂
25-7420-551	1/6		●	LED	24V	LED		7 pol. ASS2.1 7 pin ASS2.1 ♂ 4 x 2 pol. ASS2 4 x 2 pin ASS2
25-7420-701	1/6		●	LED	24V	LED		7 pol. ASS2.1 7 pin ASS2.1 ♂
25-7420-711	1/6		●	LED	24V	LED		7 pol. ASS2.1 7 pin ASS2.1 ♂ 4 x 2 pol. ASS2 4 x 2 pin ASS2
25-7420-721	1/6		●	LED	24V	LED		7 pol. ASS2.1 7 pin ASS2.1 ♂
25-7420-751	1/6		●	LED	24V	LED		7 pol. ASS2.1 7 pin ASS2.1 ♂ 4 x 2 pol. ASS2 4 x 2 pin ASS2
25-7420-761	1/6		●	LED	24V	LED		7 pol. ASS2.1 7 pin ASS2.1 ♂
25-7421-521	1/6		●	LED	24V	LED		7 pol. ASS2.1 7 pin ASS2.1 ♂ 4 x 2 pol. ASS2 4 x 2 pin ASS2
25-7402-101	1/6		●	LED	24V	LED		7 pol. ASS2.1 7 pin ASS2.1 ♂ 4 x 2 pol. ASS2 4 x 2 pin ASS2
25-7420-741	1/6		●	LED	24V	LED		7 pol. ASS2.1 7 pin ASS2.1 ♂ 4 x 2 pol. ASS2 4 x 2 pin ASS2
25-7420-771	1/6		●	LED	24V	LED		7 pol. ASS2.1 7 pin ASS2.1 ♂ 4 x 2 pol. ASS2 4 x 2 pin ASS2
25-7421-531	1/6		●	LED	24V	LED		7 pol. ASS2.1 7 pin ASS2.1 ♂ 4 x 2 pol. ASS2 4 x 2 pin ASS2





EUROPOINT III Truck Version 





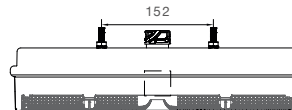
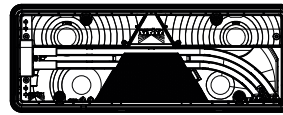

















ADR Zone 2  IP56K



Produktinformation  
Product information



 Blinklicht Direction indicator	 Rücklicht Tail light	 Bremslicht Stop light	 Nebelschlusslicht Fog light
 Rückfahrlicht Reverse light	 Seitenmarkierungslicht + Reflektor Sidemarker light + reflector		

BEST. NR							ZUSATZ	ANSCHLUSS
PART NO							ADD ON	CONNECTOR
25-7000-541	1/10	●			24V			7 pol AMP 7 pin AMP   
25-7000-751	1/10	●			24V			7 pol AMP 7 pin AMP   
25-7400-541	1/10		●		24V			7 pol AMP 7 pin AMP   
25-7400-751	1/10		●		24V			7 pol AMP 7 pin AMP   



# EUROPOINT III

ZUBEHÖR / ACCESSORIES

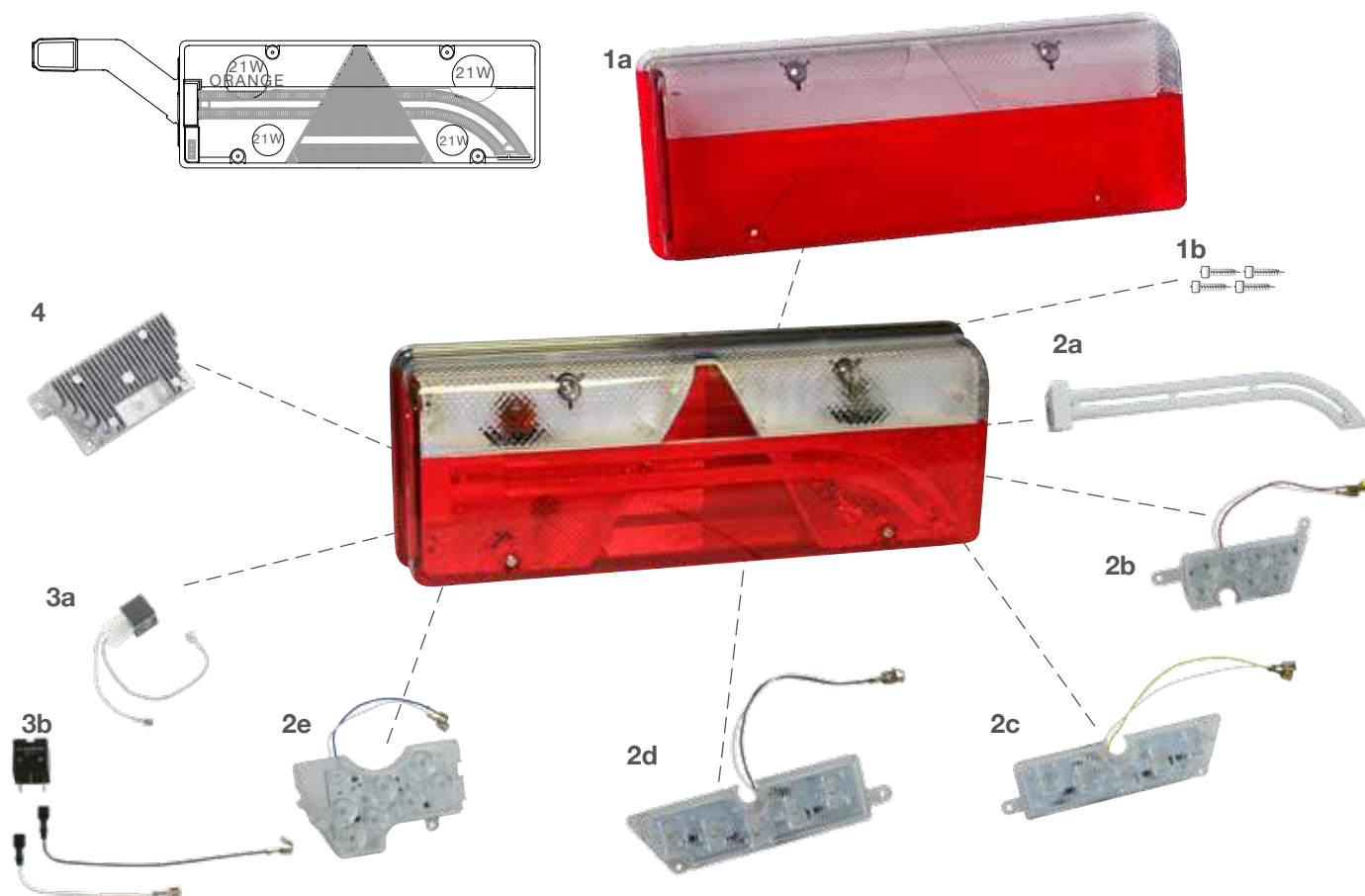

## 1 (a) Lichtscheibe | lens

- links
- left..... 18-8570-001 
- rechts
- right ..... 18-8570-101 
- links mit KZL
- left with no. plate lamp 18-8570-011 
- rechts mit KZL
- right with no. plate lamp 18-8570-111 

## (b) Schrauben für Lichtscheibe | Screws for lens

- ..... 14-1430-554 



## 2 LED Einsätze | LED inserts

- (a) Rücklicht links („Light Guide“) 12V / 24V
- tail left („Light Guide“) 12V / 24V
- ..... 12-1570-001 
- Rücklicht rechts („Light Guide“) 12V / 24V
- tail right („Light Guide“) 12V / 24V
- ..... 12-1570-101 
- (b) Bremslicht links 12V / 24V
- stop left 12V / 24V
- ..... 12-1570-204 

- Bremslicht rechts 12V / 24V
- stop light right 12V / 24V
- ..... 12-1574-204 

- (c) Blinklicht links 24V
- direction indicator left 24V
- ..... 12-1570-224 

- Blinklicht rechts 24V
- direction indicator right 24V
- ..... 12-1574-224 

- (d) Rückfahrlicht links 24V
- reverse left 24V ..... 12-1570-234 
- Rückfahrlicht rechts 24V
- reverse right 24V ..... 12-1574-234 

- (e) Nebelschlusslicht links 24V
- fog left 24V ..... 12-1570-214 
- Nebelschlusslicht rechts 24V
- fog right 24V ..... 12-1574-214 

## 3 Relais

- (a) Rückfahrwarner 24V
- reverse alarm 24V
- ..... 12-3922-004 
- (b) SMCG Steuerung für Seitenmarkierungsleuchten
- SMCG side marker control gear
- ..... 12-3970-584



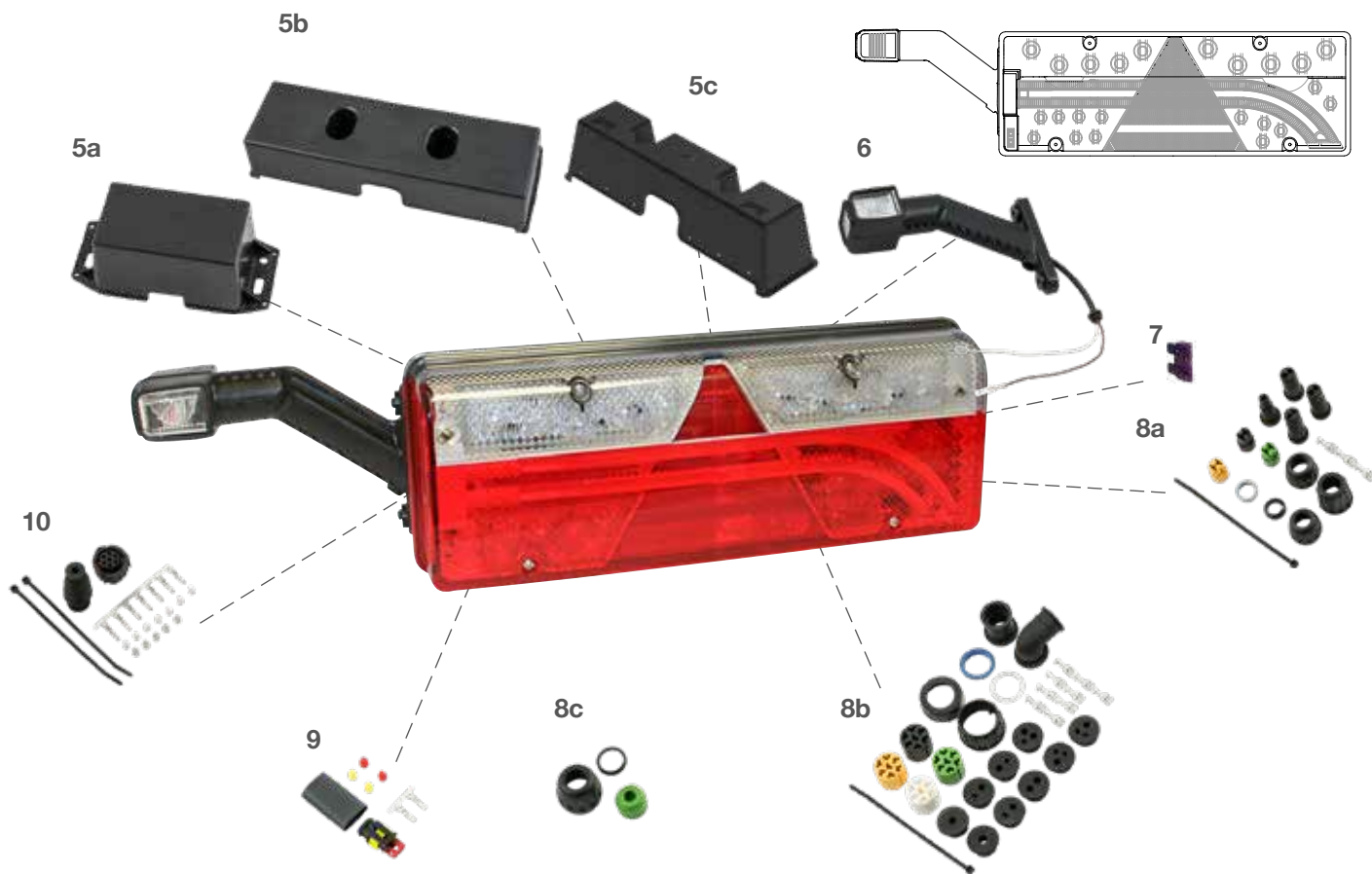

# EUROPOINT III

## ZUBEHÖR / ACCESSORIES



**4 LED Vorschaltgerät | LED control gear**  
 LCG ..... 25-7008-024   
 siehe Seite 188  
 see at page 188

**5 Schutzhaube | protection cap**  
 (a) klein  
 small ..... 15-5270-004   
 (b) groß  
 big ..... 15-5276-001   
 (c) groß  
 big ..... 25-7537-154 

**6 Umrissarm LED | outline marker LED**  
 links 12V / 24V  
 left 12V / 24V ..... 31-3103-024   
 rechts 12V / 24V  
 right 12V / 24V ..... 31-3102-024 

**7 Sicherung | fuse**  
 3 A ..... 12-6830-094 

**8 ASS1 & ASS2 Verbinder | ASS1 & ASS2 connector**  
 (a) 2 pol. weiblich  
 2 pin female ..... 13-5626-401   
 (b) 7 pol. weiblich  
 7 pin female ..... 13-5626-631   
 (c) Verschlusskappe  
 closed connection ..... 15-5623-304 

**9 Superseal Verbinder | Superseal connector**  
 2 pol. weiblich  
 2 pin female ..... 15-7002-044 

**10 AMP Verbinder | AMP connector**  
 7 pol. weiblich  
 7 pin female ..... 15-7002-024 



EUROPOINT II links  
left

ADR  
Zone 2

IP 54

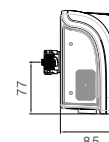
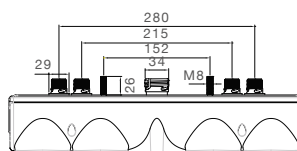
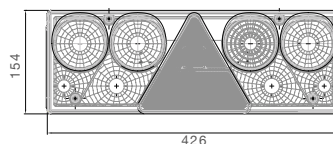

Blinklicht Direction indicator	Rücklicht Tail light	Bremslicht Stop light	Nebelschlusslicht Fog light
Rückfahrlicht Reverse light	Dreieckrückstrahler Triangle reflector	Seitenmarkierungslicht + Reflektor Sidemarker light + reflector	

BEST. NR	PART NO							ZUSATZ ADD ON	ANSCHLUSS CONNECTOR	
25-6000-501	1/10	●				24V			7 pol. ASS2 7 pin ASS2	
25-6000-701	1/10	●				24V			7 pol. ASS2 7 pin ASS2	
25-6000-711	1/10	●				24V			7 pol. ASS2.1 7 pin ASS 2.1	
25-6000-721	1/10	●				24V			7 pol. ASS2 7 pin ASS2	
25-6000-741	1/10	●				24V			7 pol. ASS2 7 pin ASS2	
25-6000-751	1/10	●				24V			7 pol. ASS2 7 pin ASS2	
25-6001-501	1/10	●				24V			7 pol. ASS2 7 pin ASS2	
25-6010-501	1/10	●				24V			7 pol. ASS2.1 7 pin ASS2.1	4 x 2 pol. ASS2 4 x 2 pin ASS2
25-6010-541	1/10	●				24V			7 pol. ASS2 7 pin ASS2	
25-6011-501	1/10	●				24V			7 pol. ASS2.1 7 pin ASS 2.1	4 x 2 pol. ASS2 4 x 2 pin ASS2
25-6030-501	1/10	●				24V			7 pol. AMP 7 pin AMP	4 x 2 pol. Superseal 4 x 2 pin Superseal
25-6030-701	1/10	●				24V			7 pol. AMP 7 pin AMP	4 x 2 pol. Superseal 4 x 2 pin Superseal
25-6030-711	1/10	●				24V			7 pol. AMP 7 pin AMP	4 x 2 pol. Superseal 4 x 2 pin Superseal
25-6101-501	1/10	●				24V			7 pol. ASS2 7 pin ASS2	2 x 2 pol. ASS2 2 x 2 pin ASS2
25-6200-501	1/10	●				24V			7 pol. ASS2 7 pin ASS2	4 x 2 pol. ASS2 4 x 2 pin ASS2
25-6030-721	1/10	●				24V			7 pol. AMP 7 pin AMP	4 x 2 pol. Superseal 4 x 2 pin Superseal



**EUROPOINT II** rechts  
right

ADR Zone 2

IP 54

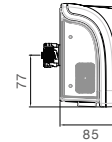
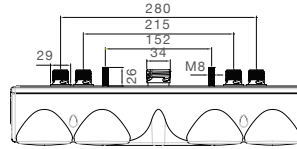
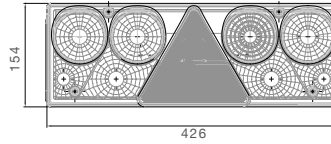

Blinklicht Direction indicator	Rücklicht Tail light	Bremslicht Stop light	Nebelschlusslicht Fog light
Rückfahrlicht Reverse light	Dreieckrückstrahler Triangle reflector	Seitenmarkierungslicht + Reflektor Sidemarker light + reflector	

BEST. NR PART NO		←	→				ZUSATZ ADD ON	ANSCHLUSS CONNECTOR	
25-6400-501	1/11		●		24V			7 pol. ASS2 7 pin ASS2	
25-6400-701	1/11		●		24V			7 pol. ASS2 7 pin ASS2	
25-6400-711	1/10		●		24V			7 pol. ASS2.1 7 pin ASS 2.1	
25-6400-721	1/10		●		24V			7 pol. ASS2 7 pin ASS2	
25-6400-741	1/10		●		24V			7 pol. ASS2 7 pin ASS2	
25-6400-751	1/10		●		24V			7 pol. ASS2 7 pin ASS2	
25-6401-501	1/10		●		24V			7 pol. ASS2 7 pin ASS2	
25-6410-501	1/10		●		24V			7 pol. ASS2.1 7 pin ASS2.1	4 x 2 pol. ASS2 4 x 2 pin ASS2
25-6411-501	1/10		●		24V			7 pol. ASS2.1 7 pin ASS 2.1	4 x 2 pol. ASS2 4 x 2 pin ASS2
25-6430-701	1/10		●		24V			7 pol. AMP 7 pin AMP	4 x 2 pol. Superseal 4 x 2 pin Superseal
25-6430-711	1/10		●		24V			7 pol. AMP 7 pin AMP	4 x 2 pol. Superseal 4 x 2 pin Superseal
25-6501-501	1/10		●		24V			7 pol. ASS2 7 pin ASS2	2 x 2 pol. ASS2 2 x 2 pin ASS2
25-6501-511	1/10		●		24V			7 pol. ASS2 7 pin ASS2	2 x 2 pol. ASS2 2 x 2 pin ASS2
25-6600-501	1/10		●		24V			7 pol. ASS2 7 pin ASS2	4 x 2 pol. ASS2 4 x 2 pin ASS2
25-6601-511	1/10		●		24V			7 pol. ASS2 7 pin ASS2	4 x 2 pol. ASS2 4 x 2 pin ASS2
25-6430-721	1/10	●			24V			7 pol. AMP 7 pin AMP	4 x 2 pol. Superseal 4 x 2 pin Superseal



**EUROPOINT II** links mit Umrissarm left with end outline marker

ADR Zone 2 IP 54

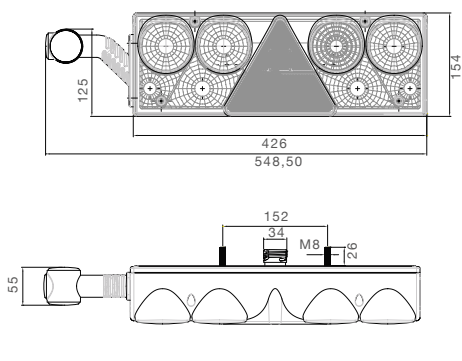

Blinklicht Direction indicator	Rücklicht Tail light	Bremslicht Stop light	Nebelschlusslicht Fog light
Rückfahrlicht Reverse light	Dreieckrückstrahler Triangle reflector	Seitenmarkierungslicht + Reflektor Sidemarker light + reflector	

BEST. NR	PART NO	Box	←	→	Light	V	LED	ZUSATZ ADD ON	ANSCHLUSS CONNECTOR	
25-6011-511	1/6	●			Light	24V	Light		7 pol. ASS2 7 pin ASS2	
25-6011-701	1/6	●			LED Light	24V	Light		7 pol. ASS2 7 pin ASS2	
25-6015-501	1/6	●			Light	24V	Light	⊖	7 pol. ASS2 7 pin ASS2	
25-6020-751	1/6	●			LED Light	24V	LED		7 pol. ASS2 7 pin ASS2	
25-6021-701	1/6	●			Light	24V	LED		7 pol. ASS2 7 pin ASS2	
25-6110-501	1/6	●			Light	24V	Light		7 pol. ASS2 7 pin ASS2	2 x 2 pol. ASS2 2 x 2 pin ASS2
25-6110-711	1/6	●			Light	24V	LED		7 pol. ASS2 7 pin ASS2	2 x 2 pol. ASS2 2 x 2 pin ASS2
25-6210-501	1/6	●			Light	24V	Light		7 pol. ASS2 7 pin ASS2	4 x 2 pol. ASS2 4 x 2 pin ASS2
25-6211-501	1/6	●			Light	24V	Light	⊖	7 pol. ASS2 7 pin ASS2	4 x 2 pol. ASS2 4 x 2 pin ASS2



**EUROPOINT II** rechts mit Umrissarm  
right with end outline marker

ADR  
Zone 2

IP 54

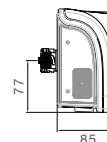
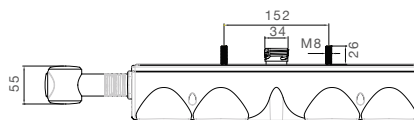
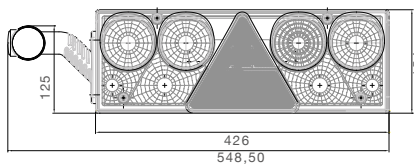

Blinklicht Direction indicator	Rücklicht Tail light	Bremslicht Stop light	Nebelschlusslicht Fog light
Rückfahrlicht Reverse light	Dreieckrückstrahler Triangle reflector	Seitenmarkierungslicht + Reflektor Sidemarker light + reflector	

BEST. NR							ZUSATZ	ANSCHLUSS
PART NO							ADD ON	CONNECTOR
25-6411-511	1/6		●		24V			7 pol. ASS2 7 pin ASS2 
25-6415-501	1/6		●		24V			7 pol. ASS2 7 pin ASS2 
25-6420-751	1/6		●	<b>LED</b>	24V	<b>LED</b>		7 pol. ASS2 7 pin ASS2 
25-6421-701	1/6		●		24V	<b>LED</b>		7 pol. ASS2 7 pin ASS2 
25-6510-501	1/6		●		24V			7 pol. ASS2 7 pin ASS2 2 x 2 pol. ASS2 2 x 2 pin ASS2
25-6510-711	1/6		●		24V	<b>LED</b>		7 pol. ASS2 7 pin ASS2 2 x 2 pol. ASS2 2 x 2 pin ASS2
25-6610-501	1/6		●		24V			7 pol. ASS2 7 pin ASS2 4 x 2 pol. ASS2 4 x 2 pin ASS2





## EUROPOINT II

ZUBEHÖR / ACCESSORIES

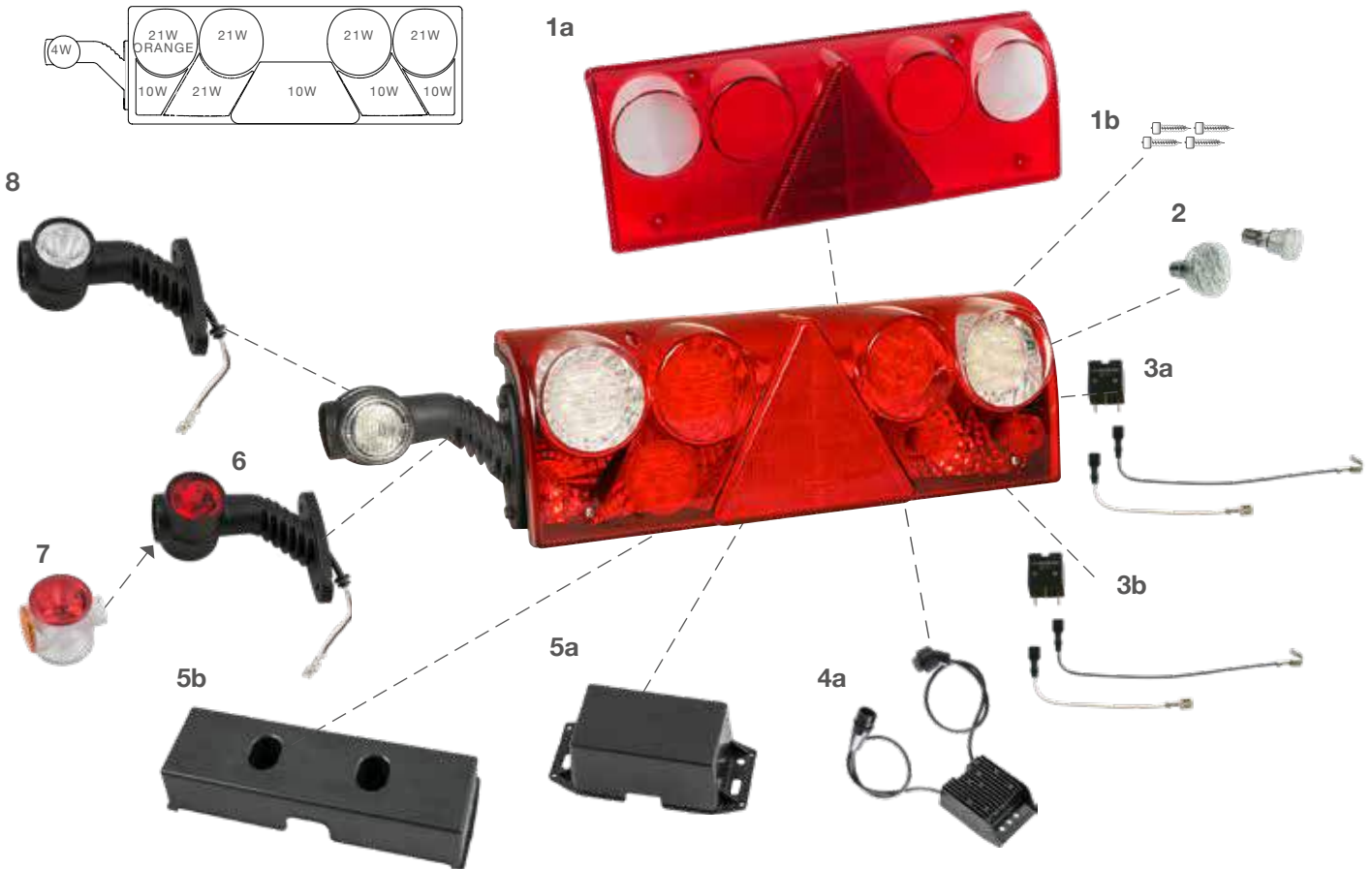

### 1 (a) Lichtscheibe | lens

..... 18-8560-002 

### (b) Schrauben für Lichtscheibe | Screws for lens

..... 14-1430-454 

### 2 LED Einsätze | LED inserts

Rücklicht 12V / 24V 

tail light 12V / 24V..... 12-1560-001 

Bremslicht 12V / 24V 

stop light 12V / 24V ..... 12-1560-141 

Blinklicht 24V 

direction indicator 24V... 12-1560-011 

Rückfahrlicht 24V 

reversing light 24V ..... 12-1560-021 

Nebelschlusslicht 24V 

fog light 24V..... 12-1560-031 

### 3 Relais

(a) Rückfahrwarner 24V  
reverse alarm 24V

..... 12-3922-004 

(b) SMCG Steuerung für Seitenmarkierungsleuchten  
SMCG side marker control gear

..... 12-3970-584

### 4 LED Vorschaltgerät | LED control gear

(a) LCG 1 - V2 ..... 75-0300-101

siehe Seite 188

see at page 188

### 5 Schutzhaube | protection cap

(a) klein 

small ..... 15-5270-004

(b) groß 

big ..... 15-5276-001

### 6 Umrissarm Glühlampe | outline marker bulb

rot / weiß / orange links 

red / white / orange left

..... 31-3305-064

rot / weiß / orange rechts 

red / white / orange right

..... 31-3306-064

### 7 Lichtscheibe Umrissarm | lens outline marker



..... 18-8141-004 



## EUROPOINT II

ZUBEHÖR / ACCESSORIES



- 8** Umrissarm LED | outline marker LED  
 rot / weiß links  
 red / white left ..... 31-3305-084   
 rot / weiß rechts  
 red / white right ..... 31-3306-084 

- 9** Sicherung | fuse  
 3 A ..... 12-6830-094 

- 10** ASS1 & ASS2 Verbinder |  
 ASS1 & ASS2 connector  
 (a) 2 pol. weiblich  
 2 pin female ..... 13-5626-401   
 (b) 7 pol. weiblich  
 7 pin female ..... 13-5626-631   
 (c) Verschlusskappe  
 closed connection ..... 15-5623-304 

- 11** Superseal Verbinder |  
 Superseal connector  
 2 pol. weiblich  
 2 pin female ..... 15-7002-044 

- 12** AMP Verbinder |  
 AMP connector  
 7 pol. weiblich  
 7 pin female ..... 15-7002-024 



# EUROPOINT I

ADR Zone 2

IP 54

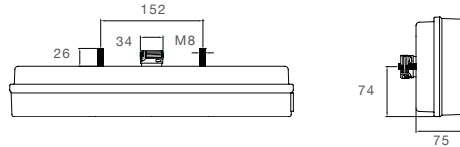
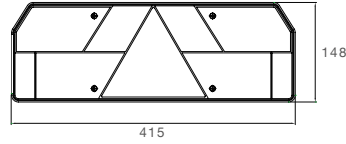

Blinklicht Direction indicator	Rücklicht Tail light	Bremslicht Stop light	Nebelschlusslicht Fog light
Rückfahrlicht Reverse light	Dreieckrückstrahler Triangle reflector	Seitenmarkierungslicht + Reflektor Sidemarker light + reflector	Begrenzungslicht hinten Rear position light

BEST. NR	PART NO							ZUSATZ ADD ON	ANSCHLUSS CONNECTOR
25-5000-501	1/10		●			24V		7 pol. ASS2 7 pin ASS2	
25-5001-501	1/10		●			24V		7 pol. ASS2 7 pin ASS2	
25-5100-501	1/13		●			24V		PG Verschraubung cable glands	
25-5400-501	1/10			●		24V		7 pol. ASS2 7 pin ASS2	
25-5401-501	1/10			●		24V		7 pol. ASS2 7 pin ASS2	
25-5500-501	1/13			●		24V		PG Verschraubung cable glands	



# EUROPOINT I

ZUBEHÖR / ACCESSORIES

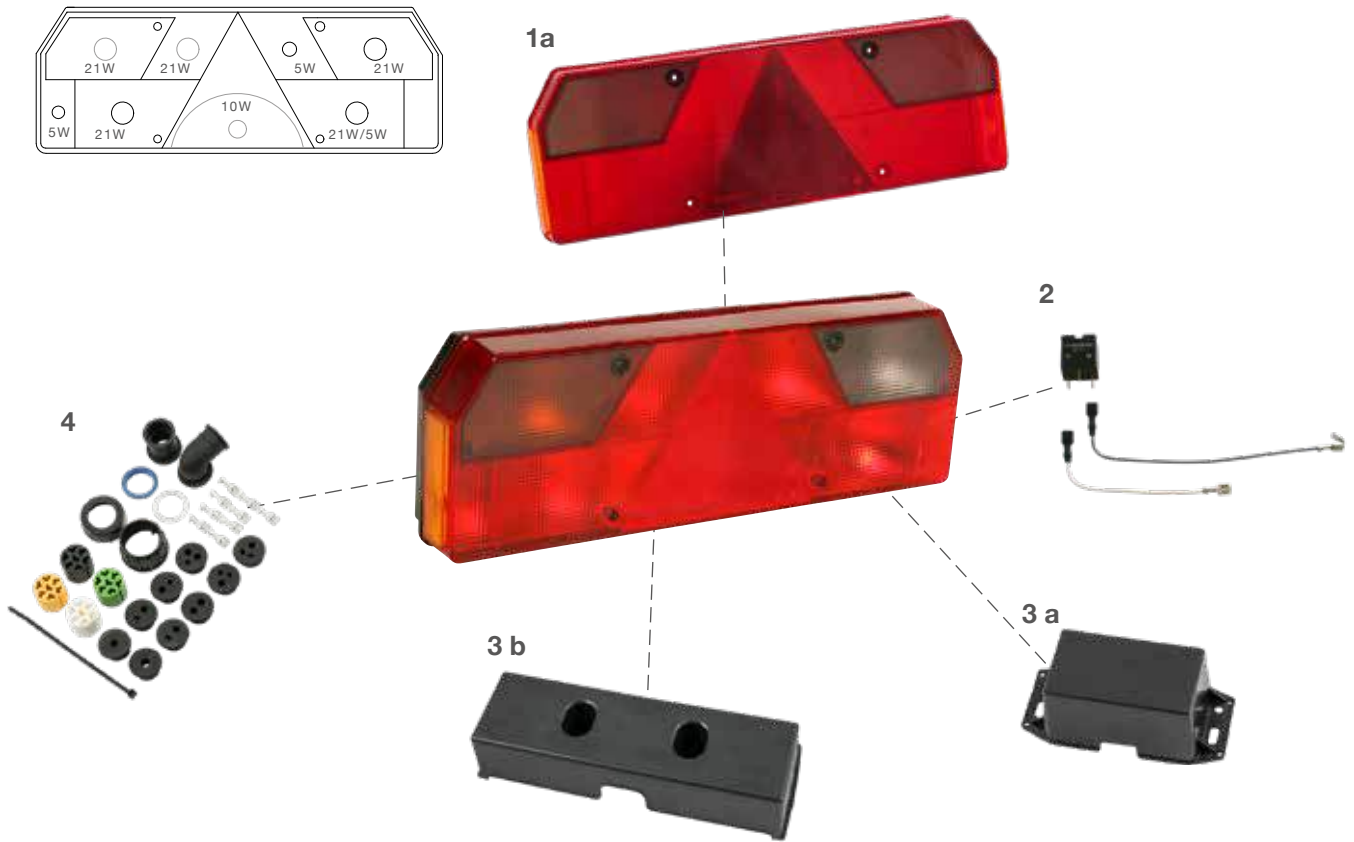

- 1 Lichtscheibe | lens**  
 (a) Ohne Kennzeichenleuchte  
 without number plate lamp  
 ..... 18-8550-002
  
- 2 Rückfahrwarner 24V | reverse alarm 24V**  
 ..... 12-3922-004
  
- 3 Schutzhaube | protection cap**  
 (a) klein  
 small ..... 15-5270-004   
 (b) groß  
 big ..... 15-5276-001
  
- 4 ASS1 & ASS2 Verbinder |  
 ASS1 & ASS2 connector**  
 7 pol. weiblich  
 7 pin female ..... 13-5626-631   
  
**Glühlampe | bulb**  
 24V 5W ..... 16-6305-027



ECOPOINT II

links  
left

ADR Zone 2 IP56K



Produktinformation  
Product information

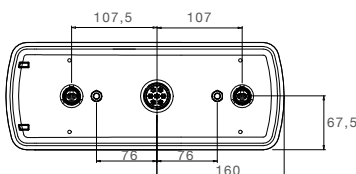
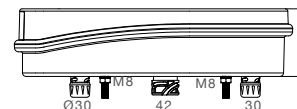
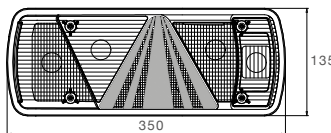

Blinklicht Direction indicator	Rücklicht Tail light	Bremslicht Stop light	Nebelschlusslicht Fog light
Rückfahrlicht Reverse light	Dreieckrückstrahler Triangle reflector	Seitenmarkierungslicht + Reflektor Sidemarker light + reflector	

BEST. NR PART NO						ZUSATZ ADD ON	ANSCHLUSS CONNECTOR
25-2800-001	1/6	●			24V		7 pol. ASS2.1 7 pin ASS2.1 ♂
25-2800-451	1/6	●		 	24V		7 pol. ASS2 7 pin ASS2 ♂
25-2800-501	1/6	●			24V		7 pol. ASS2 7 pin ASS2 ♂
25-2800-511	1/6	●			24V		7 pol. ASS2 7 pin ASS2 ♂  2 x 2 pol. ASS2 2 x 2 pin ASS2
25-2800-521	1/10	●			24V		7 pol. ASS2 7 pin ASS2 ♂  2 x 2 pol. ASS2 2 x 2 pin ASS2
25-2801-501	1/6	●			24V		7 pol. ASS2 7 pin ASS2 ♂
25-2860-001	1/6	●			24V		7 pol. ASS2.1 7 pin ASS2.1 ♂
25-2801-701	1/6	●		 	24V		7 pol. ASS2.1 7 pin ASS2.1 ♂
25-2860-701	1/8	●		 	24V	 	7 pol. ASS2.1 7 pin ASS2.1 ♂
25-2880-521	1/6	●			24V		7 pol. AMP 7 pin AMP ♂  2 x 2 pol. Superseal 2 x 2 pin Superseal
25-2860-041	1/8	●			24V	   	7 pol. ASS2.1 7 pin ASS2.1 ♂
25-2860-701	1/8	●		 	24V	   	7 pol. ASS2.1 7 pin ASS2.1 ♂



# ECOPOINT II

rechts  
right

ADR Zone 2 IP56K



Produktinformation  
Product information

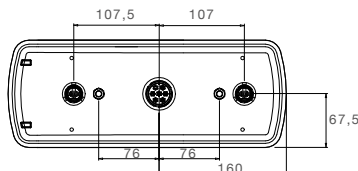
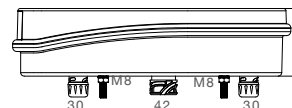
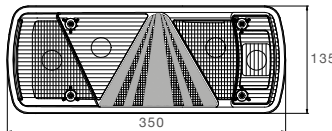

Blinklicht Direction indicator	Rücklicht Tail light	Bremslicht Stop light	Nebelschlusslicht Fog light
Rückfahrlicht Reverse light	Dreieckrückstrahler Triangle reflector	Seitenmarkierungslicht + Reflektor Sidemarker light + reflector	

BEST. NR PART NO		←	→			ZUSATZ ADD ON	ANSCHLUSS CONNECTOR
25-2900-001	1/6		●		24V		7 pol. ASS2.1 7 pin ASS2.1 ♂
25-2900-451	1/6		●		24V		7 pol. ASS2 7 pin ASS2 ♂
25-2900-501	1/6		●		24V		7 pol. ASS2 7 pin ASS2 ♂
25-2900-511	1/6		●		24V		7 pol. ASS2 7 pin ASS2 ♂  2 x 2 pol. ASS2 2 x 2 pin ASS2
25-2900-521	1/6		●		24V		7 pol. ASS2 7 pin ASS2 ♂  2 x 2 pol. ASS2 2 x 2 pin ASS2
25-2901-501	1/6		●		24V		7 pol. ASS2 7 pin ASS2 ♂
25-2901-551	1/-		●		24V		7 pol. ASS2.1 7 pin ASS2.1 ♂
25-2960-001	1/6		●		24V		7 pol. ASS2.1 7 pin ASS2.1 ♂
25-2901-701	1/6		●		24V		7 pol. ASS2.1 7 pin ASS2.1 ♂
25-2960-701	1/8		●		24V		7 pol. ASS2.1 7 pin ASS2.1 ♂
25-2980-521	1/6		●		24V		7 pol. AMP 7 pin AMP ♂  2 x 2 pol. Superseal 2 x 2 pin Superseal
25-2960-041	1/8		●		24V		7 pol. ASS2.1 7 pin ASS2.1 ♂
25-2960-701	1/8		●		24V		7 pol. ASS2.1 7 pin ASS2.1 ♂



## ECOPOINT II

links mit Umrissarm  
left with end outline marker

ADR Zone 2 IP56K

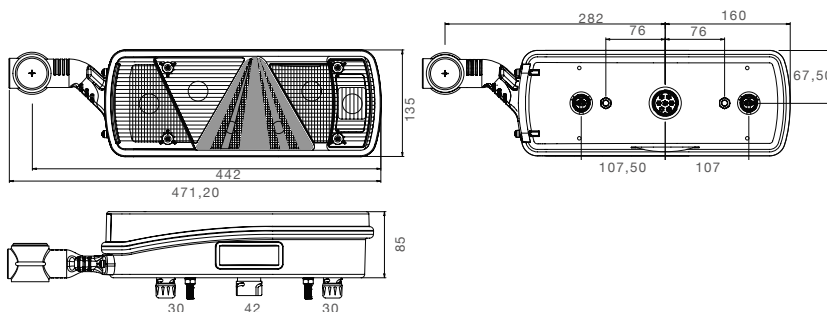

Blinklicht Direction indicator	Rücklicht Tail light	Bremslicht Stop light	Nebelschlusslicht Fog light
Rückfahrlicht Reverse light	Dreieckrückstrahler Triangle reflector	Reflektor Seitenmarkierung Reflector position light	

BEST. NR	PART NO							ZUSATZ ADD ON	ANSCHLUSS CONNECTOR
25-2810-511	1/8	●			24V			7 pol. ASS2 7 pin ASS2	2 x 2 pol. ASS2 2 x 2 pin ASS2
25-2811-501	1/8	●			24V			7 pol. ASS2 7 pin ASS2	
25-2870-401	1/-	●			24V			7 pol. ASS2.1 7 pin ASS2.1	
25-2810-501	1/8	●			24V			7 pol. ASS2 7 pin ASS2	
25-2831-501	1/6	●			24V	lang long		7 pol. ASS2.1 7 pin ASS2.1	2 x 2 pol. ASS2 2 x 2 pin ASS2
25-2832-501	1/6	●			24V	lang long		7 pol. ASS2.1 7 pin ASS2.1	
25-2810-451	1/-	●			24V	lang long		7 pol. ASS2.1 7 pin ASS2.1	
25-2820-741	1/-	●			24V	lang long		7 pol. ASS2.1 7 pin ASS2.1	2 x 2 pol. ASS2 2 x 2 pin ASS2
25-2820-501	1/8	●			24V			7 pol. ASS2 7 pin ASS2	
25-2820-541	1/8	●			24V			7 pol. ASS2.1 7 pin ASS2.1	2 x 2 pol. ASS2 2 x 2 pin ASS2
25-2880-531	1/8	●			24V			7 pol. AMP 7 pin AMP	2 x 2 pol. Superseal 2 x 2 pin Superseal



# ECOPOINT II

rechts mit Umrissarm  
right with end outline marker

ADR Zone 2 IP56K

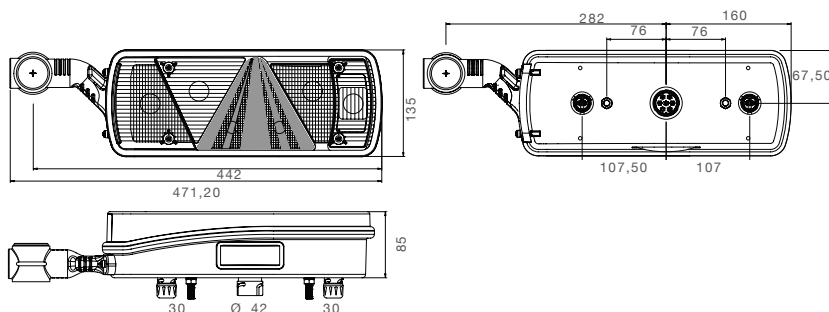

Blinklicht Direction indicator	Rücklicht Tail light	Bremslicht Stop light	Nebelschlusslicht Fog light
Rückfahrlicht Reverse light	Dreieckrückstrahler Triangle reflector	Reflektor Seitenmarkierung Reflector position light	

BEST. NR PART NO							ZUSATZ ADD ON	ANSCHLUSS CONNECTOR	
25-2910-511	1/8		●		24V			7 pol. ASS2 7 pin ASS2	2 x 2 pol. ASS2 2 x 2 pin ASS2
25-2910-551	1/-		●		24V			7 pol. ASS2.1 7 pin ASS2.1	2 x 2 pol. ASS2 2 x 2 pin ASS2
25-2911-501	1/8		●		24V			7 pol. ASS2 7 pin ASS2	
25-2911-551	1/-		●		24V			7 pol. ASS2.1 7 pin ASS2.1	
25-2970-401	1/-		●		24V			7 pol. ASS2.1 7 pin ASS2.1	
25-2910-451	1/6		●		24V	lang long		7 pol. ASS2.1 7 pin ASS2.1	
25-2931-501	1/6		●		24V	lang long		7 pol. ASS2.1 7 pin ASS2.1	2 x 2 pol. ASS2 2 x 2 pin ASS2
25-2920-741	1/-		●		24V	lang long		7 pol. ASS2.1 7 pin ASS2.1	2 x 2 pol. ASS2 2 x 2 pin ASS2
25-2932-501	1/6		●		24V	lang long		7 pol. ASS2 7 pin ASS2	
25-2920-501	1/8		●		24V	LED		7 pol. ASS2 7 pin ASS2	
25-2920-541	1/8		●		24V	LED		7 pol. ASS2.1 7 pin ASS2.1	2 x 2 pol. ASS2 2 x 2 pin ASS2
25-2980-531	1/8		●		24V	LED		7 pol. AMP 7 pin AMP	2 x 2 pol. Superseal 2 x 2 pin Superseal
25-2910-501	1/8		●		24V			7 pol. ASS2 7 pin ASS2	





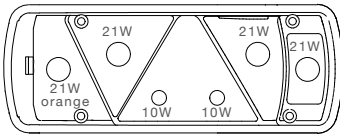

## ECOPOINT II

ZUBEHÖR / ACCESSORIES





### 1 Lichtscheibe | lens

- (a) links  
left..... 18-8528-002   
rechts  
right ..... 18-8529-002 
- (b) links ohne Dreieck  
left without triangle ..... 18-8526-002   
rechts ohne Dreieck  
right without triangle .... 18-8527-002 

### 2 LED Einsätze | LED inserts

- (a) Blinklicht links <sup>24V</sup>  
direction indicator left <sup>24V</sup>  
..... 12-1522-154   
Blinklicht rechts <sup>24V</sup>  
direction indicator right <sup>24V</sup>  
..... 12-1526-154 
- (b) Rückfahrlicht links <sup>24V</sup>  
reverse left <sup>24V</sup>  
..... 12-1522-144   
Rückfahrlicht rechts <sup>24V</sup>  
reverse right <sup>24V</sup>  
..... 12-1526-144 

- (c) Nebelschlusslicht links / rechts <sup>24V</sup>  
fog left / right <sup>24V</sup>  
..... 12-1526-164 
- (d) Rücklicht und Bremslicht links <sup>24V</sup>  
tail light and stop light left <sup>24V</sup>  
..... 12-1528-001   
Rücklicht und Bremslicht rechts <sup>24V</sup>  
tail light and stop light right <sup>24V</sup>  
..... 12-1529-001 

### 3 Relais

- (a) Rückfahrwarner <sup>24V</sup>  
reverse alarm <sup>24V</sup>  
..... 12-3922-004 
- (b) SMCG Steuerung für Seitenmarkierungsleuchten  
SMCG side marker control gear  
..... 12-3970-584

### 4 Schutzhaube | protection cap

- ..... 15-5277-004 



## ECOPOINT II

ZUBEHÖR / ACCESSORIES



### 5 Umrissarm Glühlampe | outline marker bulb

- (a) links kurz  
left short..... 31-3303-024
- rechts kurz  
right short ..... 31-3302-024
- (b) links lang  
links long ..... 31-3303-034
- rechts lang  
rechts long..... 31-3302-034

### 6 Lichtscheibe Umrissarm | lens outline marker

..... 18-8141-004

### 7 Umrissarm LED | outline marker LED

- a) links kurz  
left short..... 31-3303-044
- rechts kurz  
right short ..... 31-3302-044
- b) links lang  
links long ..... 31-3303-104
- rechts lang  
rechts long..... 31-3302-104

### 8 ASS1 & ASS2 Verbinder | ASS1 & ASS2 connector

- (a) 2 pol. weiblich  
2 pin female ..... 13-5626-401
- (b) 7 pol. weiblich  
7 pin female ..... 13-5626-631
- (c) Verschlusskappe  
closed connection ..... 15-5623-304

### 9 Superseal Verbinder | Superseal connector

- 2 pol. weiblich  
2 pin female ..... 15-7002-044

### 10 AMP Verbinder | AMP connector

- 7 pol. weiblich  
7 pin female ..... 15-7002-024



ECOPOINT I mit Dreieck  
with triangle

ADR  
Zone 2

IP 54

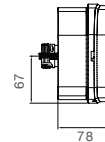
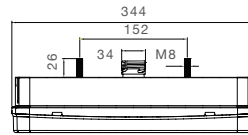
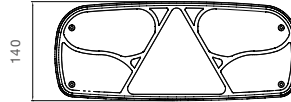

Blinklicht Direction indicator	Rücklicht Tail light	Bremslicht Stop light	Nebelschlusslicht Fog light
Rückfahrlicht Reverse light	Dreieckrückstrahler Triangle reflector		

BEST. NR	PART NO		←	→				ZUSATZ ADD ON	ANSCHLUSS CONNECTOR
25-2200-001	1/15		●			24V			7 pol. ASS2 7 pin ASS2 
25-2200-701	1/15		●			24V			7 pol. ASS2 7 pin ASS2 
25-2201-001	1/15		●			24V			7 pol. ASS2 7 pin ASS2 
25-2600-001	1/15			●		24V			7 pol. ASS2 7 pin ASS2 
25-2600-701	1/15			●		24V			7 pol. ASS2 7 pin ASS2 
25-2601-001	1/15			●		24V			7 pol. ASS2 7 pin ASS2 



**ECOPOINT I** mit Dreieck  
with triangle

ADR  
Zone 2

IP 54

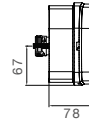
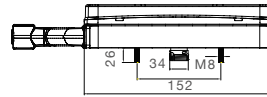
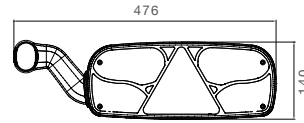

Blinklicht Direction indicator	Rücklicht Tail light	Bremslicht Stop light	Nebelschlusslicht Fog light
Rückfahrlicht Reverse light	Dreieckrückstrahler Triangle reflector		

BEST. NR	PART NO							ZUSATZ ADD ON	ANSCHLUSS CONNECTOR
25-2210-001	1/8	●			24V			7 pol. ASS2 7 pin ASS2	
25-2210-701	1/8	●			24V			7 pol. ASS2 7 pin ASS2	
25-2211-001	1/8	●			24V			7 pol. ASS2 7 pin ASS2	
25-2610-001	1/8		●		24V			7 pol. ASS2 7 pin ASS2	
25-2610-701	1/8		●		24V			7 pol. ASS2 7 pin ASS2	
25-2611-001	1/8		●		24V			7 pol. ASS2 7 pin ASS2	



ECOPOINT I mit Dreieck  
with triangle

ZUBEHÖR / ACCESSORIES

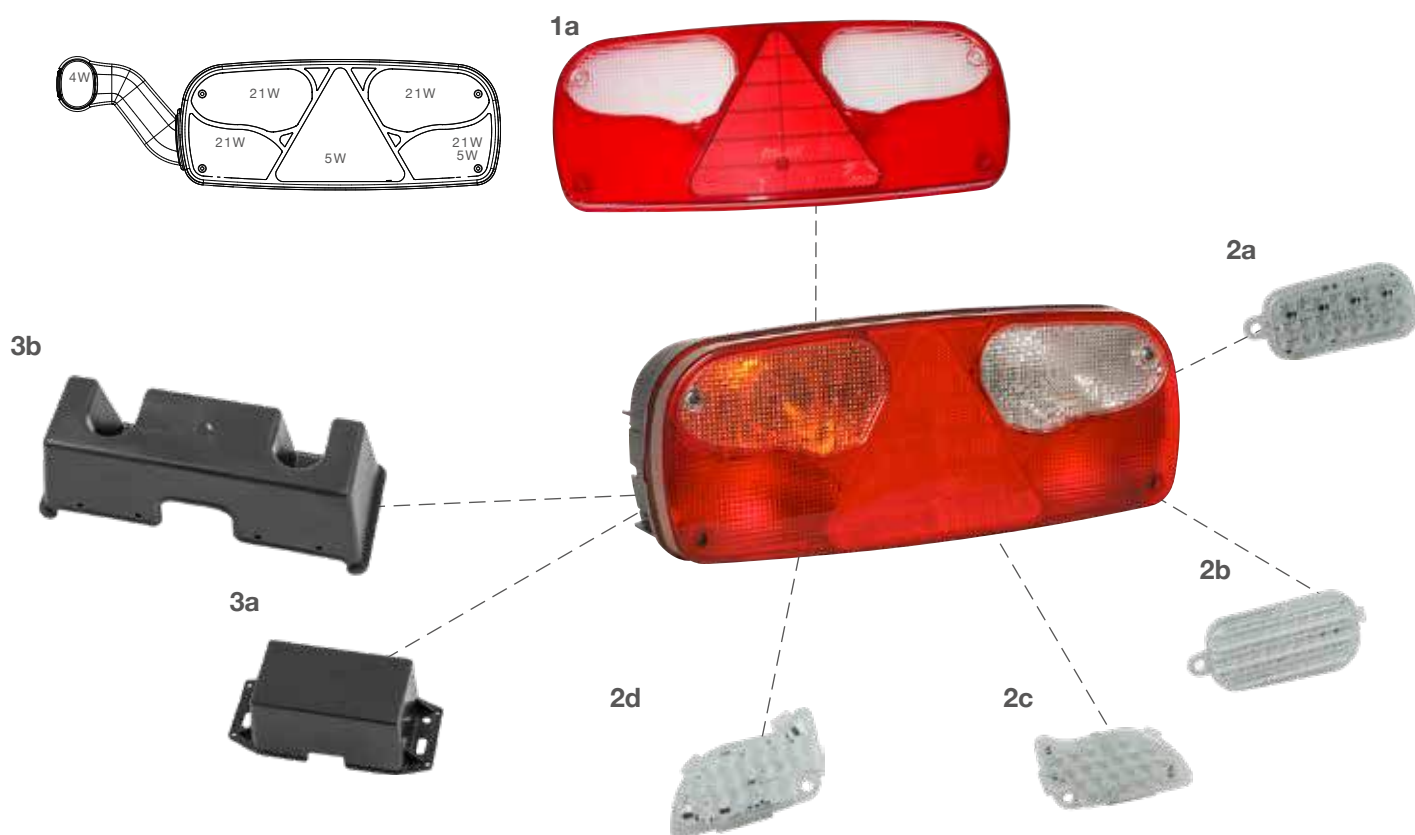

**1** **Lichtscheibe | lens**  
links / rechts  
left / right..... 18-8522-002

**2** **LED Einsätze | LED inserts**  
(a) Blinklicht links 24V  
direction indicator left 24V  
..... 12-1522-014   
Blinklicht rechts 24V  
direction indicator right 24V  
..... 12-1526-014   
(b) Rückfahrlicht links 24V  
reversing light left 24V 12-1522-034   
Rückfahrlicht rechts 24V  
reversing right 24V..... 12-1526-034   
(c) Nebelschlusslicht links 24V  
fog light left 24V..... 12-1522-024   
Nebelschlusslicht rechts 24V  
fog light right 24V..... 12-1526-024

(d) Rücklicht und Bremslicht links 24V  
tail light and stop light left 24V  
..... 12-1522-004   
Rücklicht und Bremslicht rechts 24V  
tail light and stop light right 24V  
..... 12-1526-004

**3** **Schutzhaube | protection cap**  
(a) klein  
small ..... 15-5270-004   
(b) groß  
big ..... 15-5276-001





ECOPOINT I mit Dreieck  
with triangle

ZUBEHÖR / ACCESSORIES



- 4 Umrissarm Glühlampe | outline marker bulb**  
links  
left..... 31-3608-014   
rechts  
right ..... 31-3608-004 

- 5 Lichtscheibe Umrissarm | lens outline marker**  
..... 18-8136-004 

- 6 Umrissarm LED | outline marker LED**  
links  
left..... 31-3305-174   
rechts  
right ..... 31-3306-174 

- 7 ASS1 & ASS2 Verbinder | ASS1 & ASS2 connector**  
7 pol. weiblich  
7 pin female ..... 13-5626-631 

- 8 ASS3 Verbinder | ASS3 connector**  
(a) 17 pol. weiblich  
17 pin female ..... 13-1722-001   
(b) 17 pol. männlich  
17 pin male ..... 13-1732-001 

- Glühlampe | bulb**  
24V 5W ..... 16-6305-027 



ECOPOINT | ohne Dreieck  
without triangle

ADR  
Zone 2

IP 54

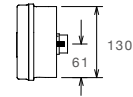
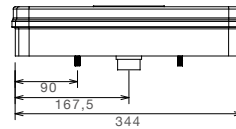
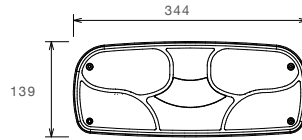

Blinklicht Direction indicator	Rücklicht Tail light	Bremslicht Stop light	Nebelschlusslicht Fog light
Rückfahrlicht Reverse light			

BEST. NR							ZUSATZ	ANSCHLUSS
PART NO							ADD ON	CONNECTOR
25-2000-501	1/15	●			24V			7 pol. ASS2 7 pin ASS2 
25-2400-501	1/15		●		24V			7 pol. ASS2 7 pin ASS2 



ECOPOINT | ohne Dreieck  
without triangle

ZUBEHÖR / ACCESSORIES



**1** Lichtscheibe | lens  
links / rechts  
left / right..... 18-8520-002

Glühlampe | bulb  
24V 5W ..... 16-6305-027

**2** Schutzhaube | protection cap  
(a) klein  
small ..... 15-5270-004   
(b) groß  
big ..... 15-5276-001

**3** ASS1 & ASS2 Verbinder |  
ASS1 & ASS2 connector  
7 pol. weiblich  
7 pin female ..... 13-5626-631





# ECOFLEX

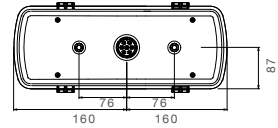
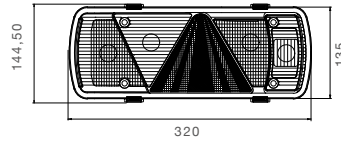

Blinklicht Direction indicator	Rücklicht Tail light	Bremslicht Stop light	Nebelschlusslicht Fog light
Rückfahrlicht Reverse light	Dreieckrückstrahler Triangle reflector		

BEST. NR	PART NO							ZUSATZ ADD ON	ANSCHLUSS CONNECTOR
25-2800-401	1/6	●			24V			7 pol. ASS2.1 7 pin ASS2.1	
25-2810-401	1/8	●			24V			7 pol. ASS2.1 7 pin ASS2.1	
25-2900-401	1/6		●		24V			7 pol. ASS2.1 7 pin ASS2.1	
25-2910-401	1/8		●		24V			7 pol. ASS2.1 7 pin ASS2.1	



# ECOFLEX

ZUBEHÖR / ACCESSORIES

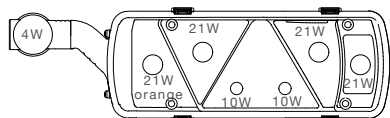



- 1** Lichtscheibe | lens  
links  
left..... 18-8528-402   
rechts  
right ..... 18-8529-402 

- 2** Clip für Lichtscheibe | clip for lens  
..... 15-5323-004 

- 3** LED Einsätze | LED insert  
Rücklicht / Bremslicht links  
tail light / stop light left  
..... 12-1528-001   
Rücklicht / Bremslicht rechts  
tail light / stop light right  
..... 12-1529-001 

- 4** ASS1 & ASS2 Verbinder |  
ASS1 & ASS2 connector  
7 pol. weiblich  
7 pin female ..... 13-5626-631 

- 5** Umrissarm Glühlampe | outline marker bulb  
(a) links lang  
left long..... 31-3303-034   
rechts lang  
right long..... 31-3302-034   
(b) links kurz  
left short..... 31-3303-024   
rechts kurz  
right short ..... 31-3302-024 



# ECOFLEX

ZUBEHÖR / ACCESSORIES



**6** Lichtscheibe Umrissarm | lens outline marker  
..... 18-8141-004

**7** Umrissarm LED | outline marker LED

- (a) links lang  
left long..... 31-3303-104
- rechts lang  
right long..... 31-3302-104
- (b) links kurz  
left short..... 31-3303-044
- rechts kurz  
right short..... 31-3302-044



# EUROFAB

ADR Zone 2 IP56K

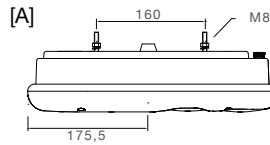
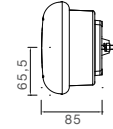
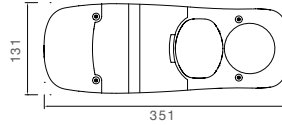

Blinklicht Direction indicator	Rücklicht Tail light	Bremslicht Stop light	Nebelschlusslicht Fog light
Rückfahrlicht Reverse light			

BEST. NR							ZUSATZ	ANSCHLUSS
PART NO							ADD ON	CONNECTOR
25-8100-001	1/10	●			12V 24V		[A]	Tülleneingang grommet
25-8100-161	1/6	●			12V		[A]	Tülleneingang grommet
25-8100-201	1/10	●			12V		[A]	7 pol. AMP 7 pin AMP
25-8100-501	1/6	●			24V		[A]	7 pol. AMP 7 pin AMP
25-8300-001	1/10		●		12V 24V		[A]	Tülleneingang grommet
25-8300-161	1/-		●		12V		[A]	Tülleneingang grommet
25-8300-201	1/10		●		12V		[A]	7 pol. AMP 7 pin AMP
25-8300-501	1/6		●		24V		[A]	7 pol. AMP 7 pin AMP



EUROFAB

ZUBEHÖR / ACCESSORIES

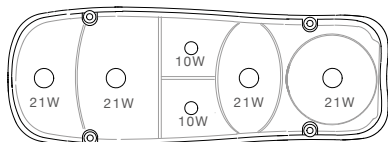

1a



1b



2



**1 (a) Lichtscheibe | lens**

links / rechts

left / right..... 18-8580-001

**(b) Schrauben für Lichtscheibe |**

**Screws for lens**

..... 14-1430-454

**2 AMP Verbinder | AMP connector**

7 pol. weiblich

7 pin female..... 15-7002-024

**Glühlampe | bulb**

12V 21W ..... 16-6121-017

12V 10W ..... 16-6110-017



# MIDILED I

ADR Zone 2 IP 6K9K



Produktinformation  
Product information

[A]

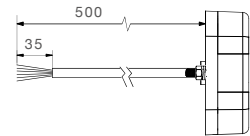
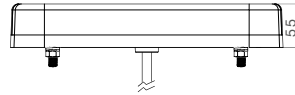
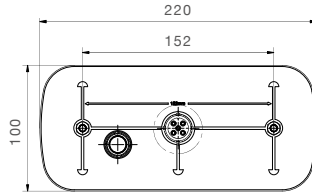

[B]

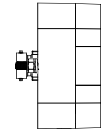
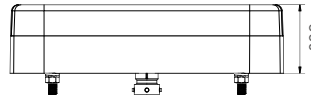

Dynamisches Blinklicht Progressive direction indicator	Rücklicht Tail light	Bremslicht Stop light	Nebelschlusslicht Fog light
Rückfahrlicht Reverse light	Dreieckrückstrahler Triangle reflector	Kennzeichenlicht Number plate holder light	

BEST. NR	PART NO	Box	←	→	Light	Voltage	ZUSATZ ADD ON	ANSCHLUSS CONNECTOR
24-3814-001	1/12	●	●	LED	12/24V		[B] 5 pol. Bajonett 5 pin Bayonet	
24-3814-011	1/12	●	●	LED	12/24V		[B] 5 pol. Bajonett 5 pin Bayonet	
34-3814-011	1/18	●	●	LED	12/24V		[A] offenes Ende open end 0,50 m	
34-3814-021	1/12	●	●	LED	12/24V		[B] offenes Ende open end 0,50 m	
34-3814-001	1/1	●	●	LED	12/24V		[A] offenes Ende open end 0,50 m	



## MIDILED I

ZUBEHÖR / ACCESSORIES



### 1 Bajonett Verbinder | bayonet connector

- (a) 5 pol. weiblich  
5 pin female ..... 13-0521-104
- (b) 5 pol. männlich  
5 pin male ..... 13-0536-044



# MIDILED I MAX

ADR Zone 2 IP 6K9K



Produktinformation  
Product information

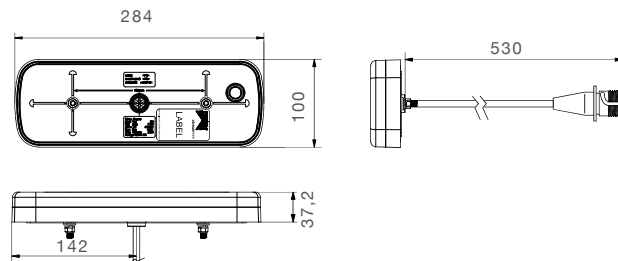

Dynamisches Blinklicht Progressive direction indicator	Rücklicht Tail light	Bremslicht Stop light	Nebelschlusslicht Fog light
Rückfahrlicht Reverse light	Dreieckrückstrahler Triangle reflector		

BEST. NR PART NO						ZUSATZ ADD ON	ANSCHLUSS CONNECTOR
35-2020-001	1/8	●	●	LED	12V		offenes Ende open end 0,50 m
35-2020-011	1/-		●	LED	12V		7 pol. ASS2 7 pin ASS2   0,50 m
35-2020-021	1/-	●		LED	12/24V		7 pol. ASS2 7 pin ASS2   0,50 m
35-2020-031	1/-	●	●	LED	12/24V		7 pol. AMP 7 pin AMP   0,50 m
35-2021-001	1/8	●	●	LED	12V		offenes Ende open end 0,50 m
35-2021-011	1/-		●	LED	12V		7 pol. ASS2 7 pin ASS2   0,50 m
35-2021-021	1/-	●		LED	12/24V		7 pol. ASS2 7 pin ASS2   0,50 m
35-2021-031	1/-	●	●	LED	12/24V		7 pol. AMP 7 pin AMP   0,50 m







# MIDILED I MAX

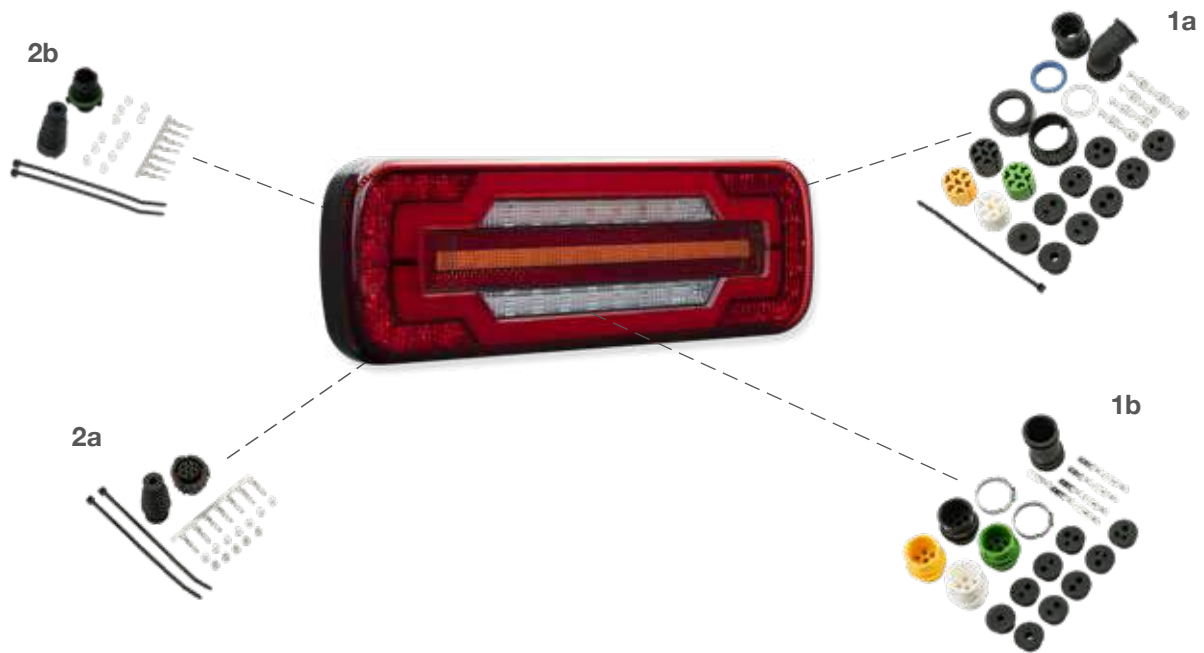

ZUBEHÖR / ACCESSORIES



## 1 ASS2 Verbinder | ASS2 connector

- (a) 7 pol. weiblich  
7 pin female ..... 13-5626-631 
- (b) 7 pol. männlich  
7 pin male ..... 13-5625-981 

## 2 AMP Verbinder | AMP connector

- (a) 7 pol. weiblich  
7 pin female ..... 15-7002-024 
- (b) 7 pol. männlich  
7 pin male ..... 15-7002-034 



# EARPOINT LED

ADR Zone 2 IP6K9K



Produktinformation  
Product information

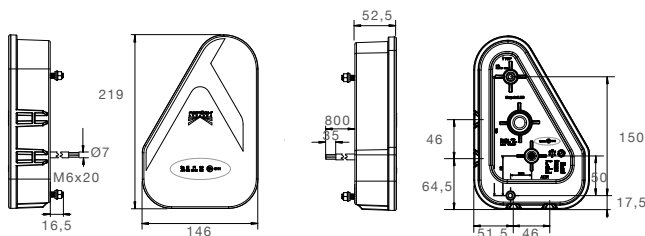

Blinklicht Direction indicator	Rücklicht Tail light	Bremslicht Stop light	Nebelschlusslicht Fog light
Rückfahrlicht Reverse light	Dreieckrückstrahler Triangle reflector		

BEST. NR							ZUSATZ	ANSCHLUSS
PART NO							ADD ON	CONNECTOR
35-0301-001	1/20	●		LED	12V 24V			offenes Ende open end 0,80 m
35-0301-011	1/12	●		LED	12V 24V			5 pol. Bajonett 5 pin Bayonet  0,80 m
35-0301-021	1/12	●		LED	12V 24V			8 pol. Bajonett 8 pin Bayonet  0,80 m
35-0301-041	1/-	●		LED	12V 24V			7 pol. ASS2 7 pin ASS2  0,80 m
35-0302-001	1/20		●	LED	12V 24V			offenes Ende open end 0,80 m
35-0302-011	1/12		●	LED	12V 24V			5 pol. Bajonett 5 pin Bayonet  0,80 m
35-0302-021	1/12		●	LED	12V 24V			8 pol. Bajonett 8 pin Bayonet  0,80 m
35-0302-041	1/-		●	LED	12V 24V			7 pol. ASS2 7 pin ASS2  0,80 m



# EARPOINT LED

ZUBEHÖR / ACCESSORIES

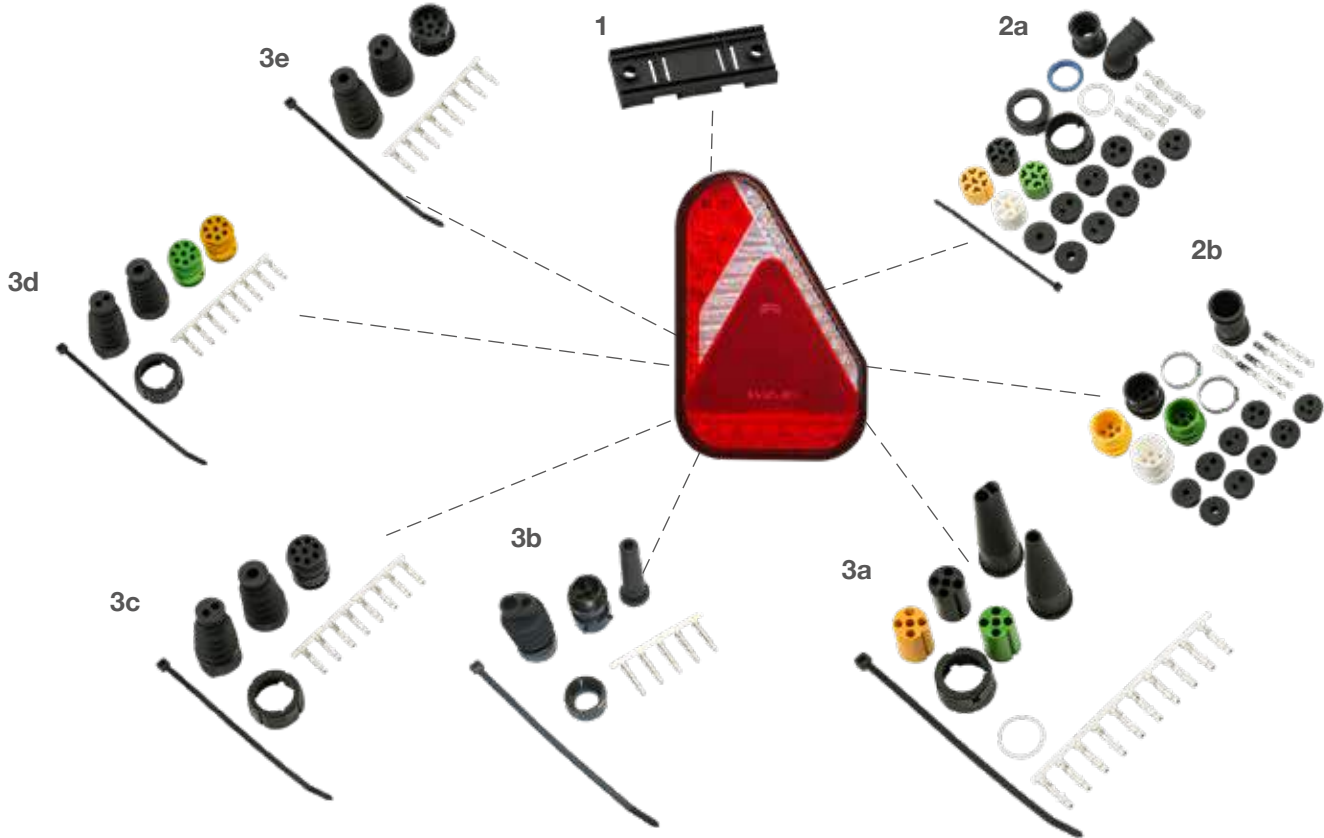

**1 Halter | bracket**  
..... 15-5303-004

**2 ASS1 & ASS2 Verbinder |  
ASS1 & ASS2 connector**  
(a) 7 pol. weiblich  
7 pin female ..... 13-5626-631   
(b) 7 pol. männlich  
7 pin male ..... 13-5625-981

**3 Bajonett Verbinder | bayonet connector**  
(a) 5 pol. weiblich  
5 pin female ..... 13-0521-104   
(b) 5 pol. männlich  
5 pin male ..... 13-0536-044   
(c) 8 pol. weiblich  
8 pin female ..... 13-0828-034   
(d) 8 pol. weiblich  
8 pin female ..... 15-0821-524   
(d) 8 pol. männlich  
8 pin male ..... 13-0838-054



# EARPOINT I

ADR  
Zone 2

IP 54

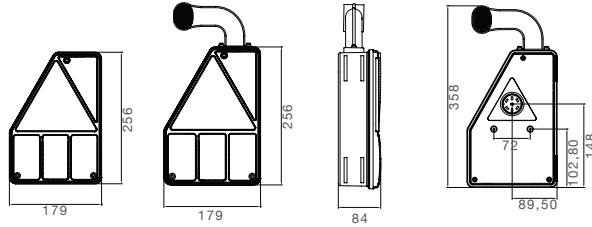

Blinklicht Direction indicator	Rücklicht Tail light	Bremslicht Stop light	
	Dreieckrückstrahler Triangle reflector		

BEST. NR							ZUSATZ	ANSCHLUSS
PART NO							ADD ON	CONNECTOR
24-4101-001	1/10	●			24V			7 pol. ASS2 7 pin ASS2
24-4105-001	1/-	●			24V			7 pol. ASS2 7 pin ASS2
24-4111-001	1/-	●			24V			PG Verschraubung cable glands
24-4151-001	1/7	●			24V			7 pol. ASS2 7 pin ASS2
24-4301-001	1/-		●		24V			7 pol. ASS2 7 pin ASS2
24-4305-001	1/20		●		24V			7 pol. ASS2 7 pin ASS2
24-4311-001	-/-		●		24V			PG Verschraubung cable glands
24-4351-001	1/6		●		24V			7 pol. ASS2 7 pin ASS2



# EARPOINT I

ZUBEHÖR / ACCESSORIES

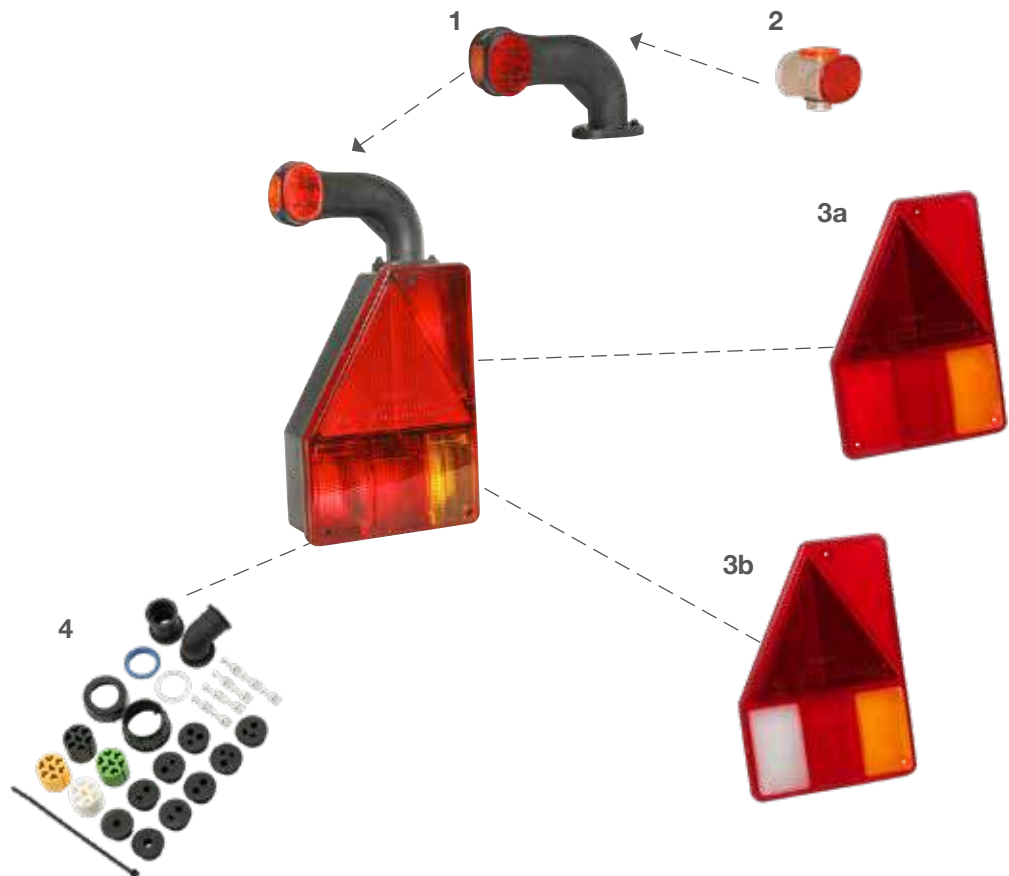
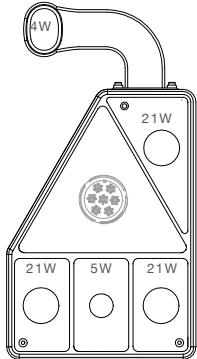

**1** Umrissarm Glühlampe | outline marker bulb  
..... 21-3800-004

**2** Lichtscheibe Umrissarm | lens outline marker  
..... 18-8136-004

**3** Lichtscheibe | lens

(a) links mit ..... 18-8440-001

rechts mit ..... 18-8442-001

(b) links mit für ..... 18-8440-051

rechts mit ..... 18-8442-101

**4** ASS1 & ASS2 Verbinder |  
ASS1 & ASS2 connector  
7 pol. weiblich  
7 pin female ..... 13-5626-631



# MULTILED IV



Produktinformation  
Product information

ISO  
13207-1

ADR  
Zone 2

IP 56

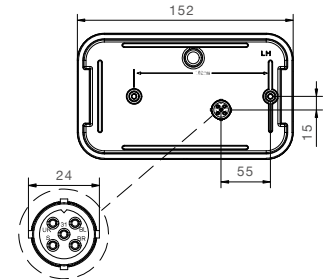
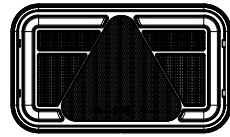

Blinklicht Direction indicator	Rücklicht Tail light	Bremslicht Stop light	Nebelschlusslicht Fog light
Rückfahrlicht Reverse light	Dreieckrückstrahler Triangle reflector	Kennzeichenlicht Number plate holder light	

BEST. NR PART NO						ZUSATZ ADD ON	ANSCHLUSS CONNECTOR
34-8941-021	1/-	●		LED	12V 24V		5 pol. Bajonett 5 pin Bayonet
34-8940-021	1/-		●	LED	12V 24V		5 pol. Bajonett 5 pin Bayonet
34-8941-031	1/-	●		LED	12V 24V		5 pol. Bajonett 5 pin Bayonet
34-8940-031	1/-		●	LED	12V 24V		5 pol. Bajonett 5 pin Bayonet
34-8941-041	1/-	●		LED	12V 24V		8 pol. Bajonett 8 pin Bayonet
34-8940-041	1/-		●	LED	12V 24V		8 pol. Bajonett 8 pin Bayonet
34-8941-051	1/-	●		LED	12V 24V		8 pol. Bajonett 8 pin Bayonet
34-8940-051	1/-		●	LED	12V 24V		8 pol. Bajonett 8 pin Bayonet
34-8941-011	1/-	●		LED	12V 24V		offenes Ende open end  0,50 m
34-8940-011	1/-		●	LED	12V 24V		offenes Ende open end  0,50 m
34-8941-001	1/-	●		LED	12V 24V		offenes Ende open end  0,50 m
34-8940-001	1/-		●	LED	12V 24V		offenes Ende open end  0,50 m



## MULTILED IV

ZUBEHÖR / ACCESSORIES

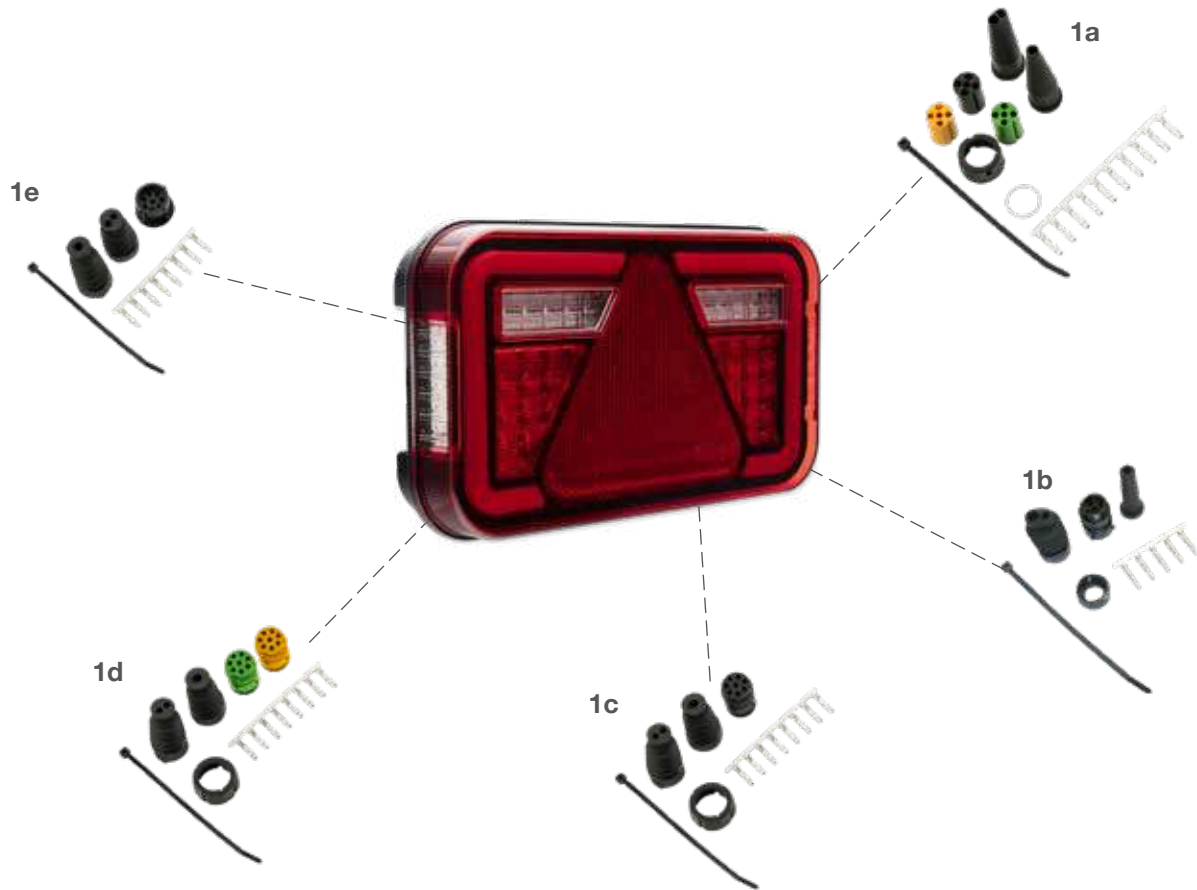

### 1 Bajonett Verbinder | bayonet connector

- (a) 5 pol. weiblich  
5 pin female ..... 13-0521-104
- (b) 5 pol. männlich  
5 pin male ..... 13-0536-044
- (c) 8 pol. weiblich  
8 pin female ..... 13-0828-034
- (d) 8 pol. weiblich  
8 pin female ..... 13-0821-524
- (e) 8 pol. männlich  
8 pin male ..... 13-0838-054



# MULTILED III TRAILER

ISO 13207-1 ADR Zone 2 IP 56



Produktinformation  
Product information

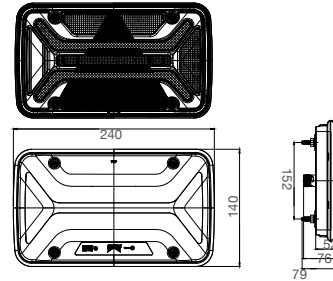

Blinklicht Direction indicator	Rücklicht Tail light	Bremslicht Stop light	Nebelschlusslicht Fog light
Rückfahrlicht Reverse light	Dreieckrückstrahler Triangle reflector		

BEST. NR	PART NO							ZUSATZ ADD ON	ANSCHLUSS CONNECTOR
24-8931-001	1/-	●		LED	12V 24V			7 pol. ASS2 7 pin ASS2	  
24-8930-001	1/-		●	LED	12V 24V			7 pol. ASS2 7 pin ASS2	  
24-8931-011	1/-	●		LED	12V 24V			7 pol. ASS2 7 pin ASS2	   2 pol ASS2 2 pin ASS2
24-8930-011	1/-		●	LED	12V 24V			7 pol. ASS2 7 pin ASS2	   2 pol ASS2 2 pin ASS2
24-8931-021	1/-	●		LED	12V 24V			7 pol ASS2 7 pin ASS2	   2 pol ASS2 2 pin ASS2
24-8930-021	1/-		●	LED	12V 24V			7 pol AMP 7 pin AMP	   2 pol ASS2 2 pin ASS2
24-8931-041	1/-	●		LED	12V 24V			7 pol. AMP 7 pin AMP	  
24-8930-041	1/-		●	LED	12V 24V			7 pol. AMP 7 pin AMP	  
24-8931-031	1/-	●		LED	12V 24V			7 pol AMP 7 pin AMP	   2 pol ASS2 2 pin ASS2
24-8930-031	1/-		●	LED	12V 24V			7 pol AMP 7 pin AMP	   2 pol ASS2 2 pin ASS2
24-8931-051	1/-	●		LED	12V 24V			7 pol AMP 7 pin AMP	   2 pol Superseal 2 pin Superseal
24-8930-051	1/-		●	LED	12V 24V			7 pol AMP 7 pin AMP	   2 pol Superseal 2 pin Superseal
24-8931-061	1/-	●		LED	12V 24V			7 pol AMP 7 pin AMP	   2 pol Superseal 2 pin Superseal
24-8930-061	1/-		●	LED	12V 24V			7 pol AMP 7 pin AMP	   2 pol Superseal 2 pin Superseal





# MULTILED III TRUCK



Produktinformation  
Product information

ISO  
13207-1

ADR  
Zone 2

IP 56

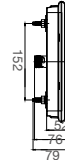
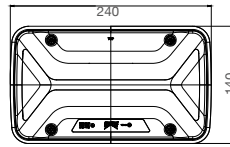
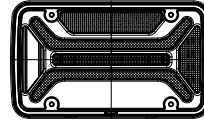

Blinklicht Direction indicator	Rücklicht Tail light	Bremslicht Stop light	Nebelschlusslicht Fog light
Rückfahrlicht Reverse light			

BEST. NR		←	→	💡	⚡	ZUSATZ	ANSCHLUSS
PART NO				LED	V	ADD ON	CONNECTOR
24-8931-071	1/-	●		LED	12V 24V		7 pol. AMP 7 pin AMP ♂
24-8930-071	1/-		●	LED	12V 24V		7 pol. AMP 7 pin AMP ♂
24-8931-081	1/-	●		LED	12V 24V		7 pol. AMP 7 pin AMP ♂  2 pol. ASS2 2 pin ASS2
24-8930-081	1/-		●	LED	12V 24V		7 pol. AMP 7 pin AMP ♂  2 pol. ASS2 2 pin ASS2



MULTILED III TRAILER

ZUBEHÖR / ACCESSORIES



- 1** Lichtscheibe | lens  
mit Dreieck ..... 24-8937-001   
ohne Dreieck ..... 24-8937-011 

- 2** ASS1 & ASS2 Verbinder |  
ASS1 & ASS2 connector  
(a) 2 pol. weiblich  
2 pin female ..... 13-5626-401   
(b) 7 pol. weiblich  
7 pin female ..... 13-5626-631   
(c) Verschlusskappe  
closed connection ..... 15-5623-304 

- 3** AMP Verbinder |  
AMP connector  
7 pol. weiblich  
7 pin female ..... 15-7002-024 

- 4** Superseal Verbinder |  
Superseal connector  
2 pol. weiblich  
2 pin female ..... 15-7002-044 



# MULTILED II hoch / high



Produktinformation  
Product information

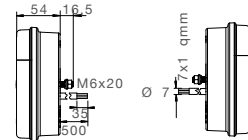
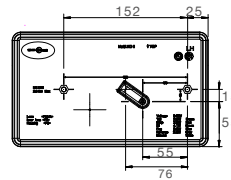
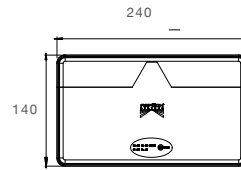

ADR Zone 2 IP6K9K

Blinklicht Direction indicator	Rücklicht Tail light	Bremslicht Stop light	Nebelschlusslicht Fog light
Rückfahrlicht Reverse light	Dreieckrückstrahler Triangle reflector		

BEST. NR						ZUSATZ	ANSCHLUSS
PART NO				LED	12V 24V	ADD ON	CONNECTOR
35-0203-001	1/-	●		LED	12V 24V		offenes Ende open end 0,50 m
35-0203-011	1/-	●		LED	12V 24V		5 pol. Bajonett 5 pin Bayonet  0,50 m
35-0203-021	1/-	●		LED	12V 24V		8 pol. Bajonett 8 pin Bayonet  0,50 m
35-0203-031	1/-	●		LED	12V 24V		7 pol. ASS2 7 pin ASS2  0,50 m
35-0203-041	1/-	●		LED	12V 24V		7 pol. AMP 7 pin AMP  0,50 m
35-0203-051	1/-	●		LED	12V 24V		offenes Ende open end 0,50 m
35-0203-061	1/-	●		LED	12V 24V		5 pol. Bajonett 5 pin Bayonet  0,50 m
35-0203-071	1/-	●		LED	12V 24V		8 pol. Bajonett 8 pin Bayonet  0,50 m
35-0203-081	1/-	●		LED	12V 24V		7 pol. ASS2 7 pin ASS2  0,50 m
35-0203-091	1/-	●		LED	12V 24V		7 pol. AMP 7 pin AMP  0,50 m
35-0203-101	1/-	●		LED	12V 24V		offenes Ende open end 0,50 m
35-0203-111	1/-	●		LED	12V 24V		5 pol. Bajonett 5 pin Bayonet  0,50 m
35-0203-121	1/5	●		LED	12V 24V		8 pol. Bajonett 8 pin Bayonet  0,50 m
35-0203-131	1/-	●		LED	12V 24V		7 pol. ASS2 7 pin ASS2  0,50 m
35-0203-141	1/-	●		LED	12V 24V		7 pol. AMP 7 pin AMP  0,50 m



# MULTILED II hoch / high



Produktinformation  
Product information

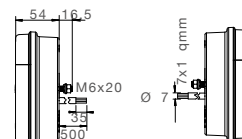
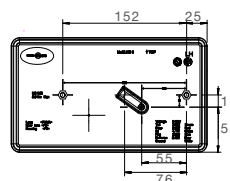
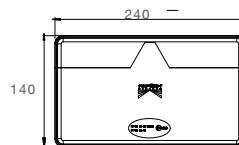

Blinklicht Direction indicator	Rücklicht Tail light	Bremslicht Stop light	Nebelschlusslicht Fog light
Rückfahrlicht Reverse light	Dreieckrückstrahler Triangle reflector		

BEST. NR	PART NO						ZUSATZ ADD ON	ANSCHLUSS CONNECTOR
35-0204-001	1/-		●	LED	12V 24V		offenes Ende open end 0,50 m	
35-0204-011	1/-		●	LED	12V 24V		5 pol. Bajonett 5 pin Bayonet  0,50 m	
35-0204-021	1/5		●	LED	12V 24V		8 pol. Bajonett 8 pin Bayonet  0,50 m	
35-0204-051	1/-		●	LED	12V 24V		offenes Ende open end 0,50 m	
35-0204-031	1/-		●	LED	12V 24V		7 pol. ASS2 7 pin ASS2  0,50 m	
35-0204-041	1/-		●	LED	12V 24V		7 pol. AMP 7 pin AMP  0,50 m	
35-0204-061	1/-		●	LED	12V 24V		5 pol. Bajonett 5 pin Bayonet  0,50 m	
35-0204-071	1/-		●	LED	12V 24V		8 pol. Bajonett 8 pin Bayonet  0,50 m	
35-0204-081	1/-		●	LED	12V 24V		7 pol. ASS2 7 pin ASS2  0,50 m	
35-0204-091	1/-		●	LED	12V 24V		7 pol. AMP 7 pin AMP  0,50 m	
35-0204-101	1/-		●	LED	12V 24V		offenes Ende open end 0,50 m	
35-0204-111	1/-		●	LED	12V 24V		5 pol. Bajonett 5 pin Bayonet  0,50 m	
35-0204-121	1/5		●	LED	12V 24V		8 pol. Bajonett 8 pin Bayonet  0,50 m	
35-0204-131	1/-		●	LED	12V 24V		7 pol. ASS2 7 pin ASS2  0,50 m	
35-0204-141	1/-		●	LED	12V 24V		7 pol. AMP 7 pin AMP  0,50 m	



MULTILED II flach / flat



Produktinformation  
Product information

ADR Zone 2 IP6K9K

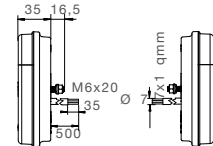
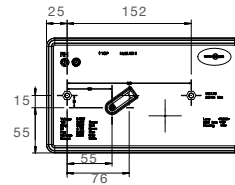
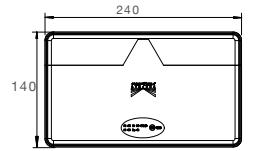

Blinklicht Direction indicator	Rücklicht Tail light	Bremslicht Stop light	Nebelschlusslicht Fog light
Rückfahrlicht Reverse light	Dreieckrückstrahler Triangle reflector		

BEST. NR		←	→				ZUSATZ	ANSCHLUSS		
PART NO							ADD ON	CONNECTOR		
35-0201-001	1/-	●		LED	12V 24V			offenes Ende open end	0,50 m	
35-0201-011	1/-	●		LED	12V 24V			5 pol. Bajonett 5 pin Bayonet		0,50 m
35-0201-021	1/-	●		LED	12V 24V			8 pol. Bajonett 8 pin Bayonet		0,50 m
35-0201-031	1/-	●		LED	12V 24V			7 pol. ASS2 7 pin ASS2		0,50 m
35-0201-041	1/-	●		LED	12V 24V			7 pol. AMP 7 pin AMP		0,50 m
35-0202-001	1/-			LED	12V 24V			offenes Ende open end	0,50 m	
35-0202-011	1/-			LED	12V 24V			5 pol. Bajonett 5 pin Bayonet		0,50 m
35-0202-021	1/-			LED	12V 24V			8 pol. Bajonett 8 pin Bayonet		0,50 m
35-0202-031	1/-			LED	12V 24V			7 pol. ASS2 7 pin ASS2		0,50 m
35-0202-041	1/-			LED	12V 24V			7 pol. AMP 7 pin AMP		0,50 m



# MULTILED II

ZUBEHÖR / ACCESSORIES

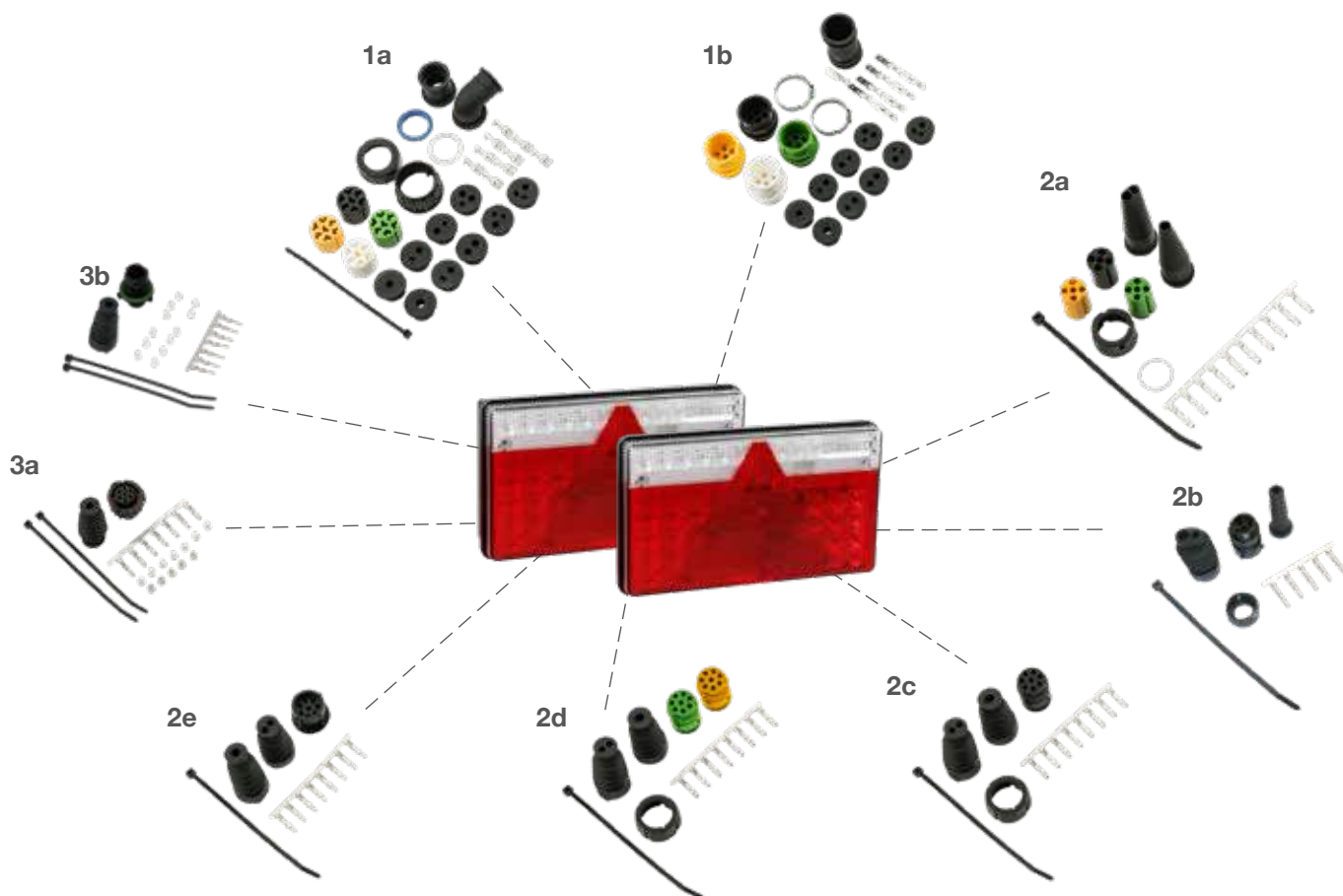

## 1 ASS1 & ASS2 Verbinder | ASS1 & ASS2 connector

- (a) 7 pol. weiblich  
7 pin female ..... 13-5626-631
- (b) 7 pol. männlich  
7 pin male ..... 13-5625-981

## 2 Bajonett Verbinder | bayonet connector

- (a) 5 pol. weiblich  
5 pin female ..... 13-0521-104
- (b) 5 pol. männlich  
5 pol. male ..... 13-0536-044
- (c) 8 pol. weiblich  
8 pin female ..... 13-0828-034
- (d) 8 pol. weiblich  
8 pin female ..... 15-0821-524
- (e) 8 pol. männlich  
8 pol. male ..... 13-0838-054

## 3 AMP Verbinder | AMP connector

- (a) 7 pol. weiblich  
7 pin female ..... 15-7002-024
- (b) 7 pol. männlich  
7 pin male ..... 15-7002-034



# MULTILED

ADR Zone 2 IP69K

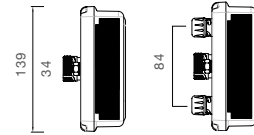
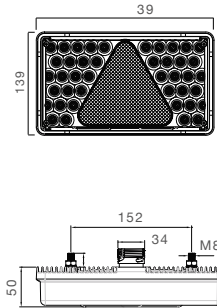

Blinklicht Direction indicator	Rücklicht Tail light	Bremslicht Stop light	Nebelschlusslicht Fog light
Rückfahrlicht Reverse light	Dreieckrückstrahler Triangle reflector	Seitenmarkierungslicht + Reflektor Sidemarker light + reflector	

BEST. NR PART NO						ZUSATZ ADD ON	ANSCHLUSS CONNECTOR
24-7400-701	1/-	●		LED	24V		7 pol. ASS2.1 7 pin ASS2.1
24-7430-701	1/10	●		LED	24V		7 pol. AMP 7 pin AMP   1 x 2 pol. ASS2 1 x 2 pin ASS2
24-7470-701	1/-	●		LED	24V		7 pol. AMP 7 pin AMP   1 x 2 pol. ASS2 1 x 2 pin ASS2
24-7630-701	1/10	●		LED	24V	Plastikgehäuse plastic housing	7 pol. AMP 7 pin AMP   1 x 2 pol. ASS2 1 x 2 pin ASS2
24-7500-701	1/10		●	LED	24V		7 pol. ASS2.1 7 pin ASS2.1
24-7530-701	1/10		●	LED	24V		7 pol. AMP 7 pin AMP   1 x 2 pol. ASS2 1 x 2 pin ASS2
24-7570-701	1/-		●	LED	24V		7 pol. AMP 7 pin AMP   1 x 2 pol. ASS2 1 x 2 pin ASS2
24-7730-701	1/10		●	LED	24V	Plastikgehäuse plastic housing	7 pol. AMP 7 pin AMP   1 x 2 pol. ASS2 1 x 2 pin ASS2



MULTILED ZUBEHÖR / ACCESSORIES

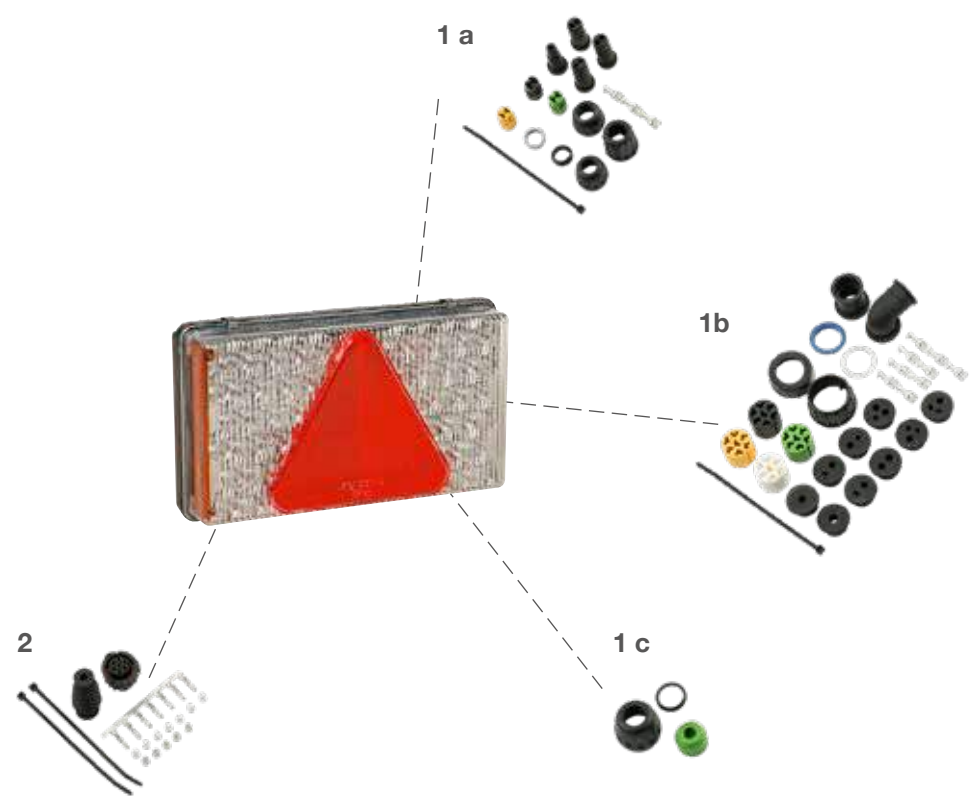

- 1 ASS1 & ASS2 Verbinder | ASS1 & ASS2 connector**
- (a) 2 pol. weiblich  
2 pin female ..... 13-5626-401
  - (b) 7 pol. weiblich  
7 pin female ..... 13-5626-631
  - (c) Verschlusskappe  
closed connection ..... 15-5623-304
- 2 AMP Verbinder | AMP connector**
- 7 pol. weiblich  
7 pin female ..... 15-7002-024

**LED Vorschaltgerät | LED control gear**  
 LCG ..... siehe Seite 188  
 ..... see at page 188





# MULTIPOINT V

ADR Zone 2

IP 54

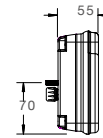
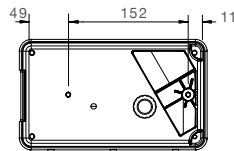
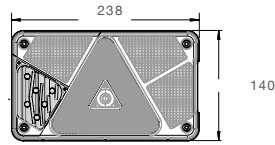

Blinklicht Direction indicator	Rücklicht Tail light	Bremslicht Stop light	Nebelschlusslicht Fog light
Rückfahrlicht Reverse light			

BEST. NR							ZUSATZ	ANSCHLUSS
PART NO							ADD ON	CONNECTOR
24-8502-001	1/-	●			24V			PG Verschraubung cable glands
24-8504-701	1/10	●			24V			PG Verschraubung cable glands
34-8503-001	1/-	●			24V			7 pol. AMP 7 pin AMP  0,15 m
34-8505-001	1/10	●			24V			7 pol. ASS2 7 pin ASS2  2,50 m
34-8605-001	1/12	●			24V			7 pol. ASS2 7 pin ASS2  0,90 m
24-8702-001	1/-		●		24V			PG Verschraubung cable glands
24-8714-701	1/10		●		24V			PG Verschraubung cable glands
34-8702-001	1/-		●		24V			7 pol. AMP 7 pin AMP  0,15 m
34-8706-001	1/4		●		24V			7 pol. ASS2 7 pin ASS2  2,50 m
34-8806-001	1/12		●		24V			7 pol. ASS2 7 pin ASS2  0,90 m



**MULTIPOINT V** ZUBEHÖR / ACCESSORIES

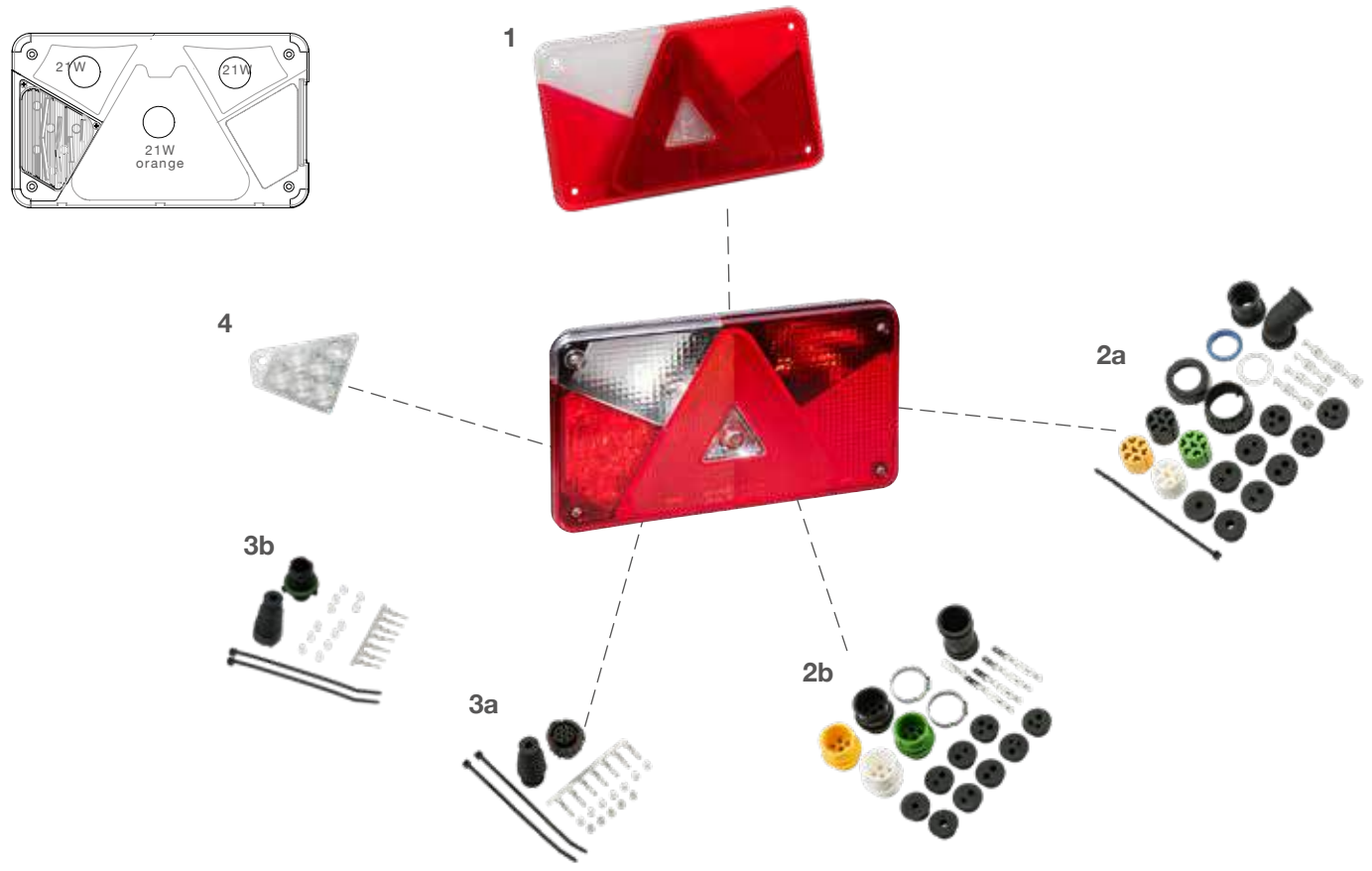

- 1 Lichtscheibe | lens**  
 links  
 left..... 18-8485-004   
 rechts  
 right ..... 18-8487-004

- 2 ASS1 & ASS2 Verbinder | ASS1 & ASS2 connector**  
 (a) 7 pol. weiblich  
 7 pin female ..... 13-5626-631   
 (b) 7 pol. männlich  
 7 pin male ..... 13-5625-981

- 3 AMP Verbinder | AMP connector**  
 (a) 7 pol. weiblich  
 7 pin female ..... 15-7002-024   
 (b) 7 pol. männlich  
 7 pin male ..... 15-7002-034

- 4 LED Einsätze | LED insert**  
 Rücklicht / Bremslicht links  
 tail light / stop light left  
 ..... 12-1530-004   
 Rücklicht / Bremslicht rechts  
 tail light / stop light right  
 ..... 12-1531-004



# MULTIPOINT LED

ADR Zone 2

IP 54

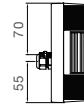
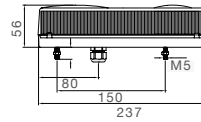
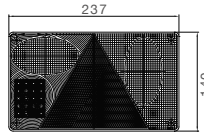

Blinklicht Direction indicator	Rücklicht Tail light	Bremslicht Stop light	
		Seitenmarkierungslicht + Reflektor Sidemarker light + reflector	

BEST. NR		←	→				ZUSATZ	ANSCHLUSS				
PART NO							ADD ON	CONNECTOR				
24-5700-721	1/10	●			24V			PG 11 Verschraubung cable glands 11				
34-5703-001	1/10	●			24V			8 pol. Bajonett 8 pin Bayonet	♀		1,80 m	
34-5703-011	1/-	●			24V			8 pol. Bajonett 8 pin Bayonet	♀		1,80 m	
34-5705-001	1/-	●			24V			7 pol. ASS2 7 pin ASS2	♀		2,50 m	
24-5800-731	1/10		●		24V			PG 11 Verschraubung cable glands 11				
24-5805-711	1/-		●		24V			Tülleneingang grommet				
24-5813-701	1/-		●		24V			Tülleneingang grommet				
34-5802-001	1/10		●		24V			8 pol. Bajonett 8 pin Bayonet	♀		1,80 m	
34-5802-011	1/-		●		24V			8 pol. Bajonett 8 pin Bayonet	♀		2,50 m	
34-5806-001	1/-		●		24V			7 pol. ASS2 7 pin ASS2	♀		2,50 m	



# MULTIPOINT LED

ZUBEHÖR / ACCESSORIES

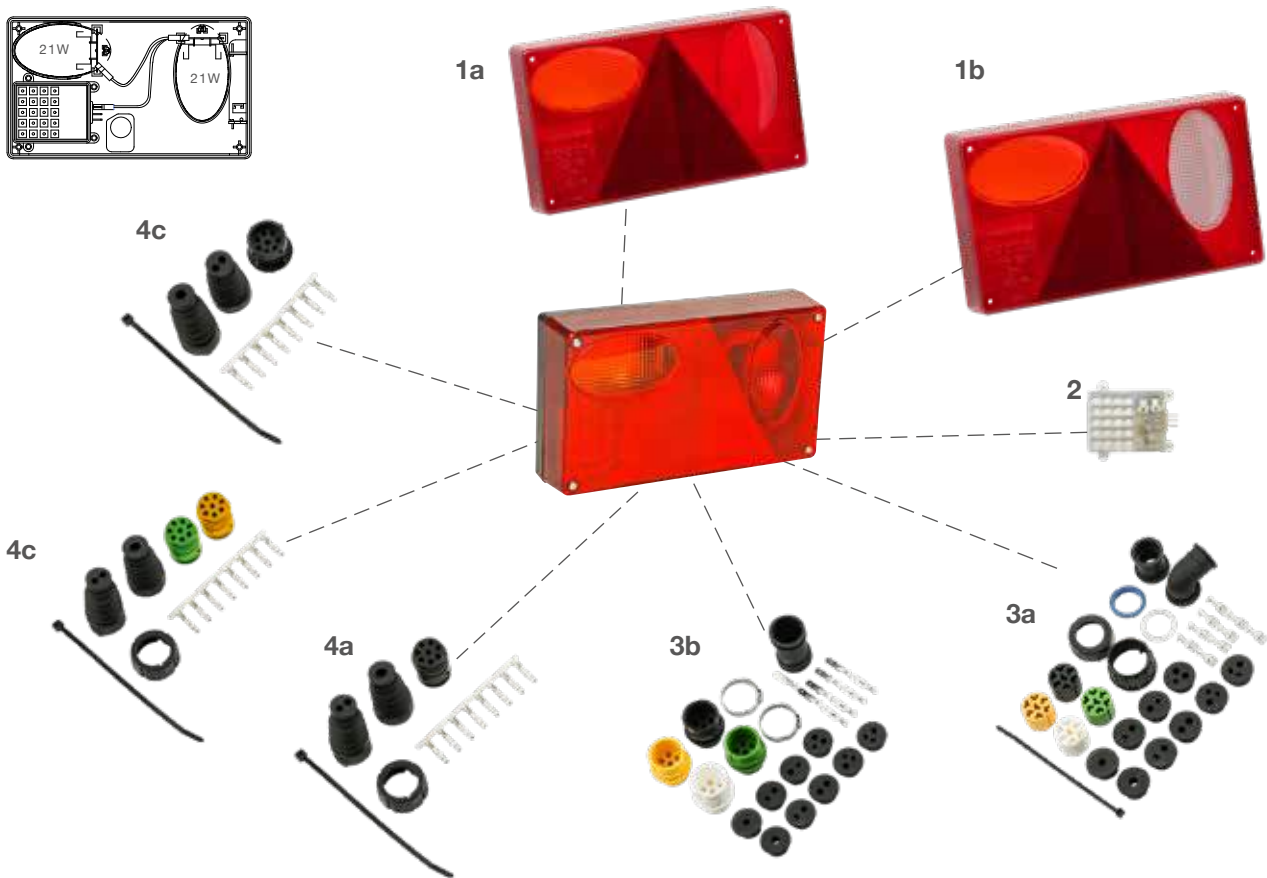
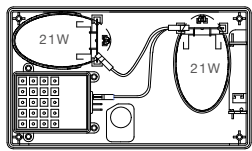

## 1 Lichtscheibe | lens

- (a) links mit left with ..... 18-8457-131
- rechts mit right with ..... 18-8458-051
- (b) links mit für left with for ..... 18-8457-051
- rechts mit right with ..... 18-8458-131

## 2 LED Einsätze | LED inserts

- ..... 12-1527-004

## 3 ASS1 & ASS2 Verbinder | ASS1 & ASS2 connector

- (a) 7 pol. weiblich  
7 pin female ..... 13-5626-631
- (b) 7 pol. männlich  
7 pin male ..... 13-5625-981

## 4 Bajonett Verbinder | bayonet connector

- (a) 8 pol. weiblich  
8 pin female ..... 13-0828-034
- (b) 8 pol. weiblich  
8 pin female ..... 15-0821-524
- (c) 8 pol. männlich  
8 pin male ..... 13-0838-054



# MINILED II

ADR Zone 2 IP6K9K



Produktinformation  
Product information

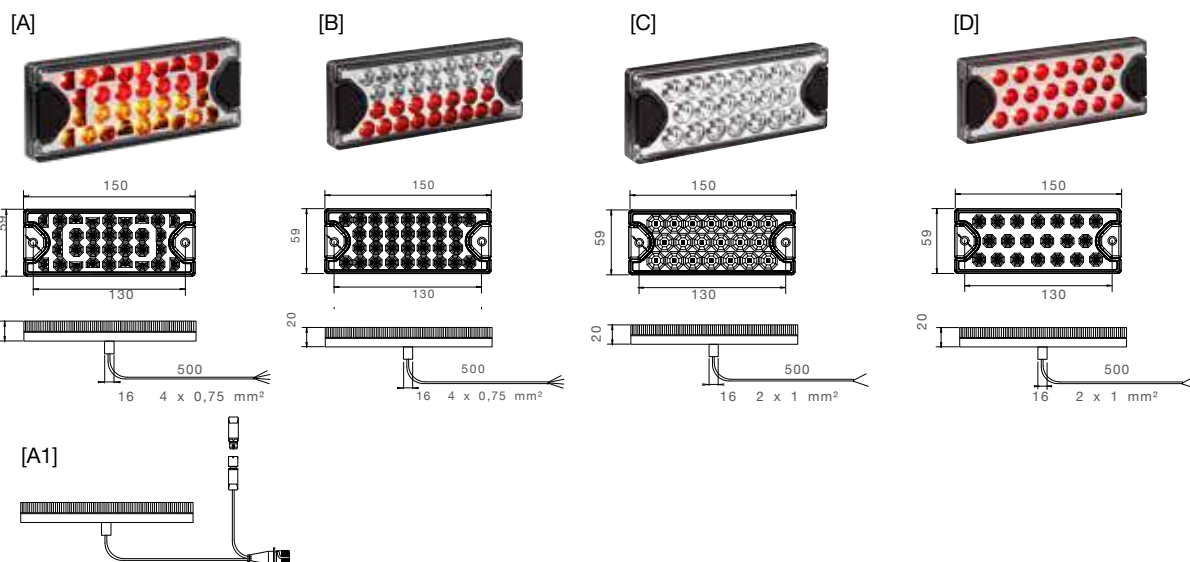

BEST. NR PART NO	Box	←	→	LED	12V 24V	Light icon	FUNKTION	ANSCHLUSS	Length	Cable icon
							FUNCTION	CONNECTOR		
32-7200-001	1/20	●	●	LED	12V 24V	[B]	⚡ ⚡	offenes Ende open end	0,50 m	↗
32-7207-001	1/50	●	●	LED	12V 24V	[B]	⚡ ⚡	3 pol. ASS3 3 pin ASS3	0,50 m	↗
33-7200-001	1/20	●	●	LED	12V 24V	[A]	⬅ ➡ ⚡	offenes Ende open end	0,50 m	↗
33-7200-011	1/-	●	●	LED	12V 24V	[A]	⬅ ➡ ⚡	offenes Ende open end	5,00 m	↗
33-7207-041	1/-	●		LED	12V 24V	[A1]	⬅ ➡ ⚡	7 pol. ASS2 7 pin ASS2	0,50 m	↗
								3 pol. ASS3 3 pin ASS3	0,25 m	↗
33-7207-051	1/-		●	LED	12V 24V	[A1]	⬅ ➡ ⚡	7 pol. ASS2 7 pin ASS2	0,50 m	↗
								3 pol. ASS3 3 pin ASS3	0,25 m	↗
37-7200-001	1/20	●	●	LED	12V 24V	[D]	⚡	offenes Ende open end	0,50 m	↗
37-7207-001	1/30	●	●	LED	12V 24V	[D]	⚡	2 pol. ASS3 2 pin ASS3	0,50 m	↗
38-7200-001	1/20	●	●	LED	12V 24V	[C]	⚡	offenes Ende open end	0,50 m	↗
38-7207-001	1/20	●	●	LED	12V 24V	[C]	⚡	2 pol. ASS3 2 pin ASS3	0,50 m	↗



# MINILED II

ZUBEHÖR / ACCESSORIES

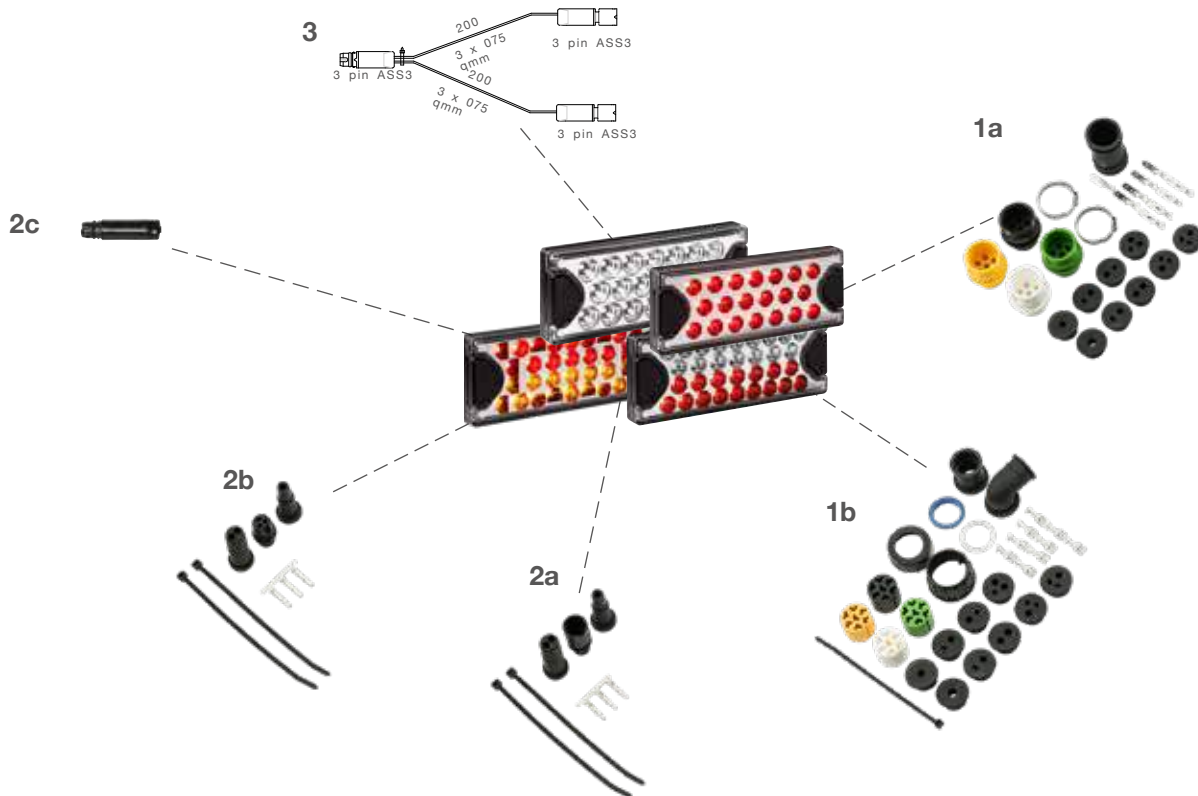

- 1 ASS1 & ASS2 Verbinder | ASS1 & ASS2 connector**
- (a) 7 pol. männlich  
7 pin male ..... 13-5625-981
  - (b) 7 pol. weiblich  
7 pin female ..... 13-5626-631
- 2 ASS3 Verbinder | ASS3 connector**
- (a) 3 pol. männlich  
3 pin male ..... 13-0332-281
  - (b) 3 pol. weiblich  
3 pin female ..... 13-0322-281
  - (c) 3 pol. Verschlusskappe  
3 pin connection ..... 13-0320-004
- 3 Y-Kabel 3 pol. ASS3 | Y-cable 3 pin ASS3**
- ..... 65-6502-014



# LINEPOINT II

ADR Zone 2 IP 6K9K



Produktinformation  
Product information

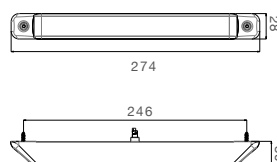

BEST. NR							FUNKTION	ANSCHLUSS	
PART NO							FUNCTION	CONNECTOR	
31-9207-031	-/-	●		LED	12V 24V			2 pol. ASS3 2 pin ASS3 ♀	0,50 m
31-9207-071	-/-	●		LED	12V 24V			2 pol. ASS3 2 pin ASS3 ♀	0,25 m
31-9231-201	1/-	●		LED	12V 24V			offenes Ende open end	0,50 m
31-9207-021	1/40		●	LED	12V 24V			2 pol. ASS3 2 pin ASS3 ♀	0,50 m
31-9207-061	1/50		●	LED	12V 24V			2 pol. ASS3 2 pin ASS3 ♀	0,25 m
31-9231-211	1/-		●	LED	12V 24V			offenes Ende open end	0,50 m
31-9207-011	1/-	●	●	LED	12V 24V			3 pol. ASS3 3 pin ASS3 ♀	0,50 m
31-9231-001	1/-	●	●	LED	12V 24V			offenes Ende open end	0,50 m
31-9207-001	1/-	●	●	LED	12V 24V			3 pol. ASS3 3 pin ASS3 ♀	0,50 m
31-9230-001	1/-	●	●	LED	12V 24V			offenes Ende open end	0,50 m
31-9207-081	1/50	●	●	LED	12V 24V			3 pol. ASS3 3 pin ASS3 ♀	0,25 m
37-9207-001	1/-	●	●	LED	12V 24V			3 pol. ASS3 3 pin ASS3 ♀	0,50 m
37-9230-001	1/-	●	●	LED	12V 24V			offenes Ende open end	0,50 m
38-9207-001	1/-	●	●	LED	12V 24V			3 pol. ASS3 3 pin ASS3 ♀	0,50 m
38-9230-001	1/-	●	●	LED	12V 24V			offenes Ende open end	0,50 m
38-9231-001	1/-	●	●	LED	12V 24V			offenes Ende open end	0,50 m
38-9237-001	1/-	●	●	LED	12V 24V			3 pol. ASS3 3 pin ASS3 ♀	0,50 m
38-9207-021	-/-	●	●	LED	12V 24V			3 pol. ASS3 3 pin ASS3 ♀	0,25 m



# LINEPOINT II

ZUBEHÖR / ACCESSORIES

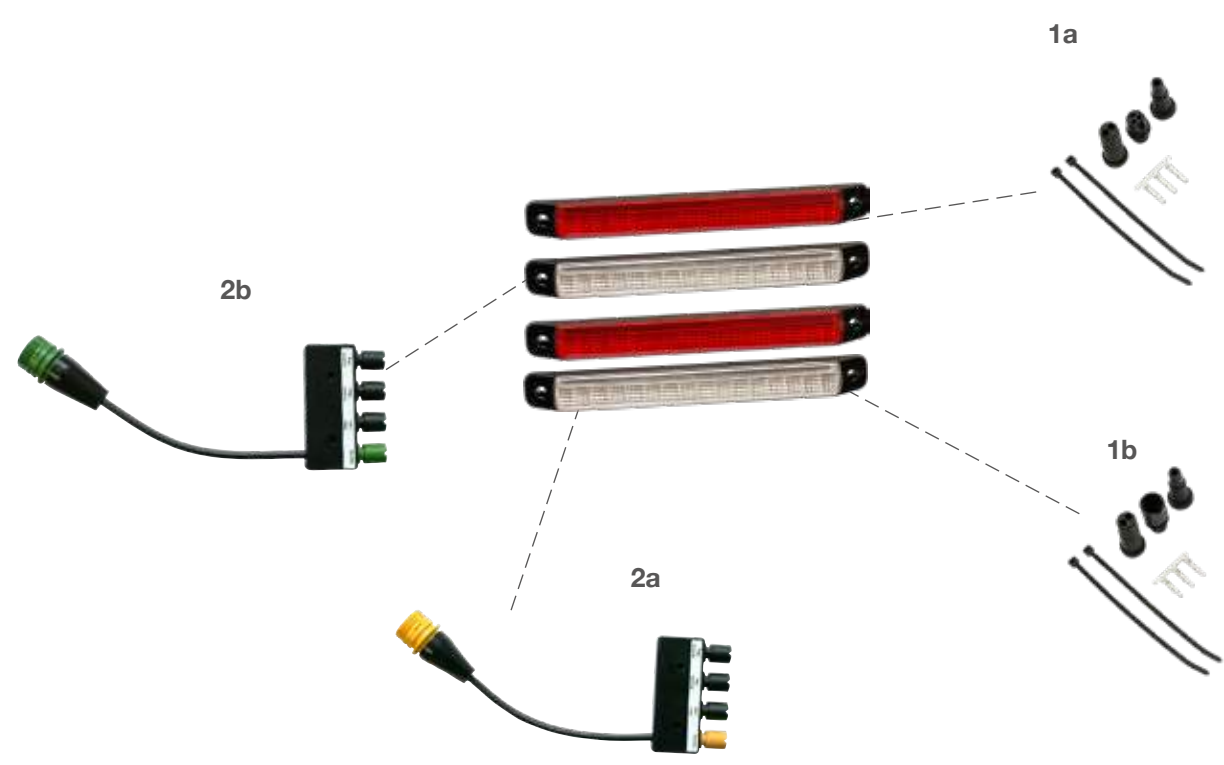

- 1 ASS3 Verbinder | ASS3 connector**
- (a) 3 pol. weiblich  
3 pin female ..... 13-0322-281
  - (b) 3 pol. männlich  
3 pin male ..... 13-0332-281
- 2 ASS3 Verteiler | ASS3 junction box**
- (a) links  
left..... 76-9027-001
  - (b) rechts  
right ..... 76-9028-001





# LINEPOINT I

ADR Zone 2 IP6K9K



Produktinformation  
Product information

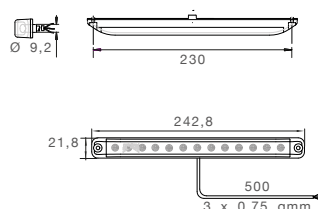

BEST. NR		←	→	LED	12V 24V	FUNKTION	ANSCHLUSS
PART NO	Box					FUNCTION	CONNECTOR
31-8920-001	1/-	●	●	LED	12V 24V	↔ ↑↓	offenes Ende 2 pol. open end 2 pin 0,50 m
31-8927-001	1/50	●	●	LED	12V 24V	↔ ↑↓	2 pol. ASS3 2 pin ASS3 ♀ 0,50 m
31-9207-041	1/50	●	●	LED	12V 24V	↔ ↑↓	3 pol. ASS3 3 pin ASS3 ♀ 0,50 m
31-9207-051	1/50	●	●	LED	12V 24V	↔ ↑↓	2 pol. ASS3 2 pin ASS3 ♀ 0,50 m
31-9220-001	1/-	●	●	LED	12V 24V	↔ ↑↓	offenes Ende 3 pol. open end 3 pin 0,50 m
31-9220-011	1/40	●	●	LED	12V 24V	↔ ↑↓	3 pol. AMP 3 pin AMP ♂ 0,15 m
31-9221-001	1/-	●	●	LED	12V 24V	↔ ↑↓	offenes Ende 2 pol. open end 2 pin 0,50 m
31-9221-011	1/40	●	●	LED	12V 24V	↔ ↑↓	2 pol. Superseal 2 pin Superseal ♂ 0,15 m
37-9207-011	1/50	●	●	LED	12V 24V	↔ ↑↓	3 pol. ASS3 3 pin ASS3 ♀ 0,50 m
37-9220-001	1/-	●	●	LED	12V 24V	↔ ↑↓	offenes Ende 2 pol. open end 2 pin 0,50 m
37-9220-011	1/40	●	●	LED	12V 24V	↔ ↑↓	2 pol. Superseal 2 pin Superseal ♂ 0,15 m
38-9207-011	1/-	●	●	LED	12V 24V	↔ ↑↓	2 pol. ASS3 2 pin ASS3 ♀ 0,50 m
38-9220-001	1/-	●	●	LED	12V 24V	↔ ↑↓	offenes Ende 2 pol. open end 2 pin 0,50 m
38-9220-011	1/40	●	●	LED	12V 24V	↔ ↑↓	2 pol. Superseal 2 pin Superseal ♂ 0,15 m
33-8914-001	1/-	●	●	LED	12V 24V	↔ ↑↓	offenes Ende open end 0,50 m
33-8914-011	1/-	●	●	LED	12V 24V	↔ ↑↓	offenes Ende open end 5,00 m



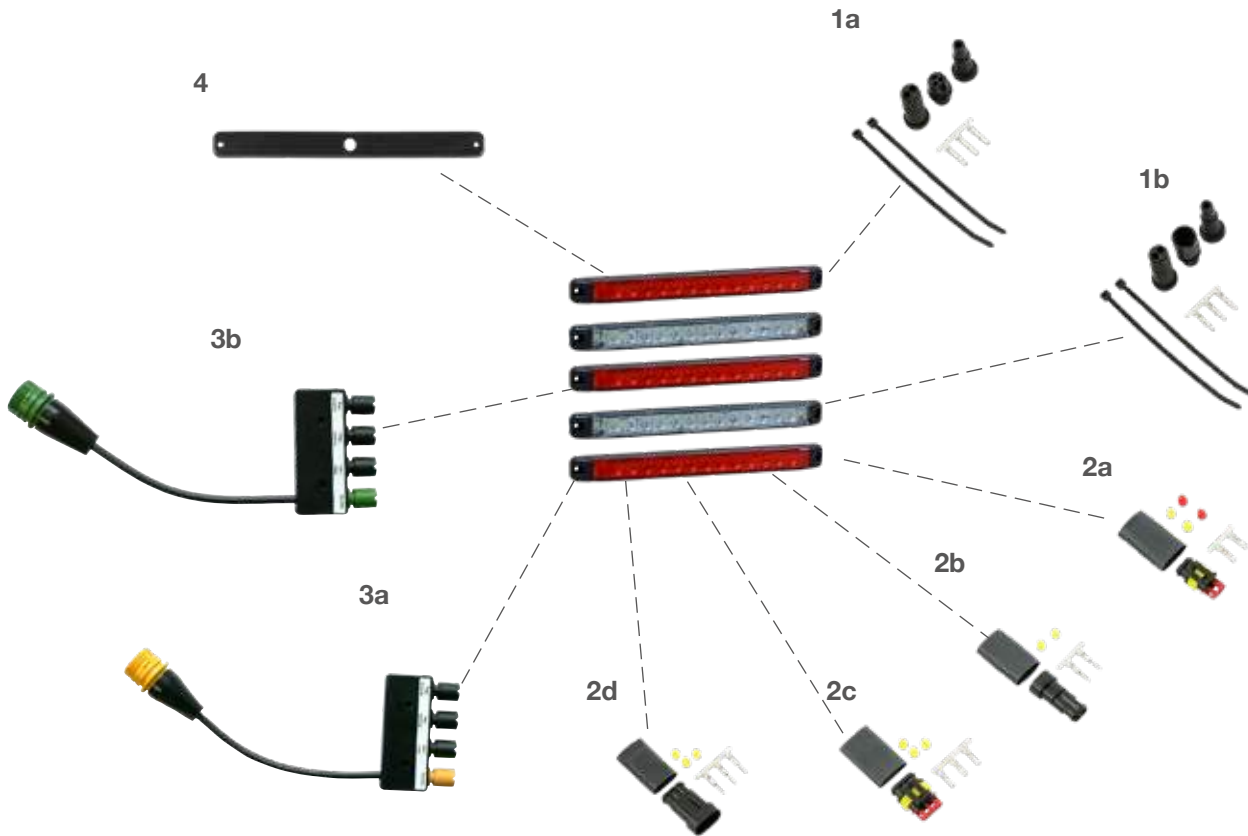

# LINEPOINT I

ZUBEHÖR / ACCESSORIES



## 1 ASS3 Verbinder | ASS3 connector

- (a) 3 pol. weiblich  
3 pin female ..... 13-0322-281 
- (b) 3 pol. männlich  
3 pin male ..... 13-0332-281 

## 2 Superseal Verbinder | Superseal connector

- (a) 2 pol. weiblich  
2 pin female ..... 15-7002-044
- (b) 2 pol. männlich  
2 pin male ..... 15-7002-054
- (c) 3 pol. weiblich  
3 pin female ..... 15-7002-064
- (d) 3 pol. männlich  
3 pin male ..... 15-7002-074

## 3 ASS3 Verteiler | ASS3 junction box

- (a) links  
left ..... 76-9027-001 
- (b) rechts  
right ..... 76-9028-001 

## 4 Gummiunterlage | rubber pad

- ..... 15-5111-404 



# POSIPOINT IV

ADR Zone 2 IP6K9K



Produktinformation  
Product information

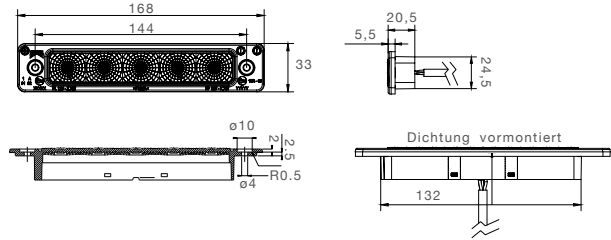

BEST. NR		←	→	LED	V	FUNKTION	ANSCHLUSS
PART NO	☐	●	●	LED	V	FUNCTION	CONNECTOR
32-7344-024	1/-	●	●	LED	12V	↔ ⊕ ⊖	Lear 16644.559.699 ♂ ⊕ ⊖ 0,20 m ↗
33-7344-014	1/-	●	●	LED	12/24V	↔ ⊕ ⊖	offenes Ende open end 0,50 m ↗
33-7344-044	1/-	●	●	LED	12V	⊕ ⊖ ↔ ⊕ ⊖	4 pol. Deutsch 4 pin Deutsch ♂ ⊕ ⊖ ⊕ ⊖
33-7344-024	1/-	●	●	LED	12V	⊕ ⊖ ↔ ⊕ ⊖	5 pol. Bajonett 5 pin Bayonet ♂ ⊕ ⊖ ⊕ ⊖
32-7344-014	1/-	●	●	LED	12/24V	↔ ⊕ ⊖ ↔	offenes Ende open end 0,50 m ↗



# POSIPOINT IV

ZUBEHÖR / ACCESSORIES

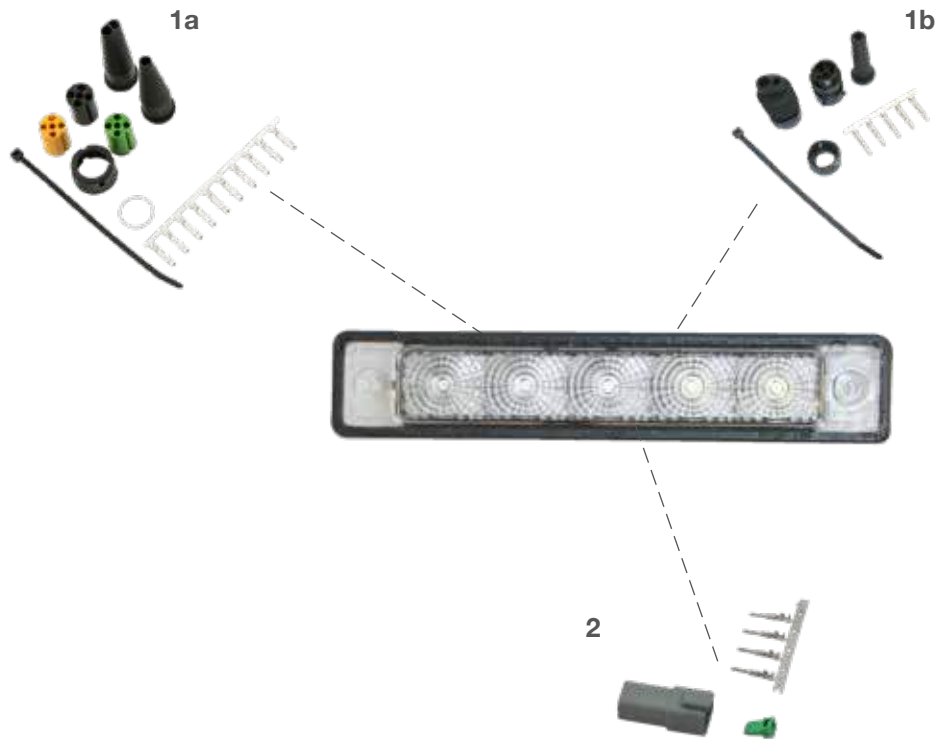

## 1 Bajonett Verbinder | bayonet connector

- (a) 5 pol. weiblich  
5 pin female ..... 13-0521-104
- (b) 5 pol. männlich  
5 pin male ..... 13-0536-044

## 2 Deutsch Verbinder | Deutsch connector

- 4 pol. männlich  
4 pin male ..... 15-7002-145



# BRASPOINT 98

ADR Zone 2 IP 6K9K



Produktinformation  
Product information

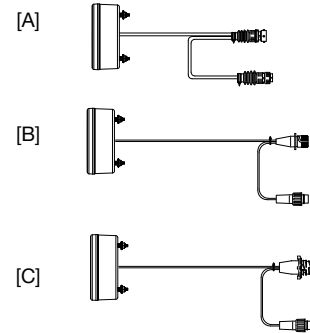
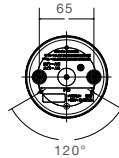
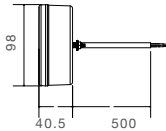

Blinklicht Direction indicator	Rücklicht Tail light	Bremslicht Stop light	

BEST. NR PART NO		←	→				ZUSATZ ADD ON	ANSCHLUSS CONNECTOR
33-9200-001	1/-	●	●	LED	12V 24V			offenes Ende open end 0,50 m
33-9200-011	1/-	●	●	LED	12V 24V			offenes Ende open end 7,00 m
33-9200-021	1/-	●	●	LED	12V 24V			offenes Ende open end 2,00 m
33-9200-501	1/-	●	●	LED	12V 24V			5 pol. Bajonett 5 pin Bayonet   0,50 m
33-9200-511	1/-	●	●	LED	12V 24V		[A]	8 pol. Bajonett 8 pin Bayonet   0,50 m
		●	●					8 pol. Bajonett 8 pin Bayonet   0,25 m
33-9207-051	1/-	●	●	LED	12V 24V		[B]	7 pol. ASS2 7 pin ASS2   0,50 m
		●	●					7 pol. ASS2 7 pin ASS2   0,20 m
33-9207-081	1/-	●	●	LED	12V 24V		[C]	7 pol. AMP 7 pin AMP   0,50 m
		●	●					7 pol. ASS2 7 pin ASS2   0,20 m
33-9280-001	1/25	●	●	LED	12V 24V			4 pol. AMP 4 pin AMP   0,50 m



# BRASPOINT 98

ADR Zone 2 IP 6K9K



Produktinformation  
Product information

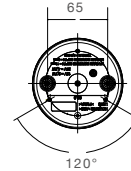
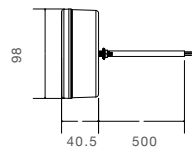

Rücklicht Tail light	Nebelschlusslicht Fog light
Rückfahrlicht Reverse light	Rückstrahler rot Reflector red

BEST. NR	Box	←	→	LED	V		ZUSATZ	ANSCHLUSS
PART NO							ADD ON	CONNECTOR
33-8100-001	1/-	●	●	LED	12V 24V			offenes Ende open end 0,50 m
33-8100-101	1/-	●	●	LED	12V 24V			offenes Ende open end 0,50 m
33-8100-501	1/-	●	●	LED	12V 24V			8 pol. Bajonett 8 pin Bayonet 0,50 m
33-8100-601	1/-	●	●	LED	12V 24V			8 pol. Bajonett 8 pin Bayonet 0,50 m
33-8107-041	1/-	●	●	LED	12V 24V			7 pol. ASS2 7 pin ASS2 0,50 m
33-8107-051	1/-	●	●	LED	12V 24V			7 pol. ASS2 7 pin ASS2 0,50 m
33-8180-001	1/10	●	●	LED	12V 24V			4 pol. AMP 4 pin AMP 0,50 m



# BRASPOINT 98

ZUBEHÖR / ACCESSORIES

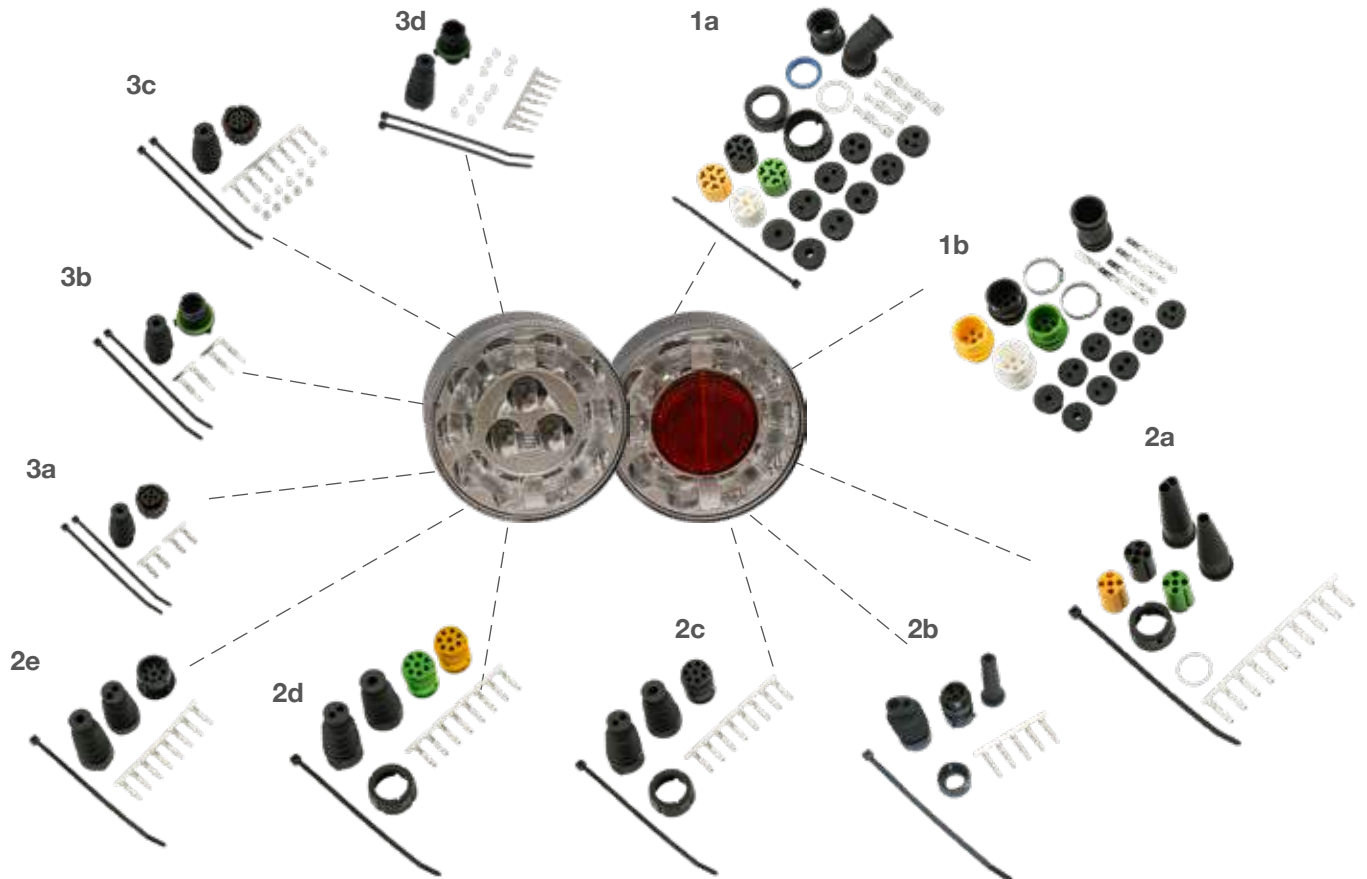

## 1 ASS1 & ASS2 Verbinder | ASS1 & ASS2 connector

- (a) 7 pol. weiblich  
7 pin female ..... 13-5626-631
- (b) 7 pol. männlich  
7 pin male ..... 13-5625-981

## 2 Bajonett Verbinder | bayonet connector

- (a) 5 pol. weiblich  
5 pin female ..... 13-0521-104
- (b) 5 pol. männlich  
5 pin male ..... 13-0536-044
- (c) 8 pol. weiblich  
8 pin female ..... 13-0828-034
- (d) 8 pol. weiblich  
8 pin female ..... 15-0821-524
- (e) 8 pol. männlich  
8 pin male ..... 13-0838-054

## 3 AMP Verbinder | AMP connector

- (a) 4 pol. weiblich  
4 pin female ..... 15-7002-004
- (b) 4 pol. männlich  
4 pin male ..... 15-7002-014
- (c) 7 pol. weiblich  
7 pin female ..... 15-7002-024
- (d) 7 pol. männlich  
7 pin male ..... 15-7002-034



# BRASPOINT 140

ADR Zone 2 IP 6K9K



Produktinformation  
Product information

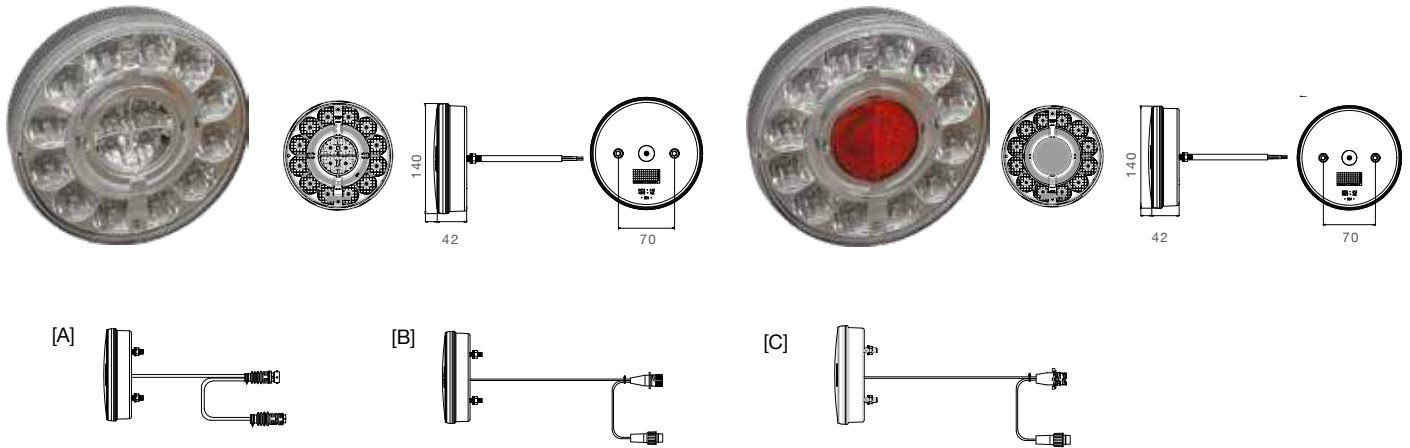

BEST. NR PART NO		←	→				FUNKTION FUNCTION	ANSCHLUSS CONNECTOR
33-9200-201	1/-	●	●	LED	12V 24V			offenes Ende open end 0,50 m
33-9200-701	1/-	●	●	LED	12V 24V			5 pol. Bajonett 5 pin Bayonet ♂  0,50 m
33-9200-711	1/-	●	●	LED	12V 24V		[A]	8 pol. Bajonett 8 pin Bayonet ♂  0,50 m
		●	●					8 pol. Bajonett 8 pin Bayonet ♀  0,25 m
33-9207-061	1/12	●	●	LED	12V 24V		[B]	7 pol. ASS2 7 pin ASS2 ♂  0,50 m
		●	●					7 pol. ASS2 7 pin ASS2 ♀  0,20 m
33-9207-091	1/12	●	●	LED	12V 24V		[C]	7 pol. AMP 7 pin AMP ♂  0,50 m
		●	●					7 pol. ASS2 7 pin ASS2 ♀  0,20 m
33-9200-221	1/-	●	●	LED	12V 24V			offenes Ende open end 1,50 m
33-9200-531	1/-	●	●	LED	12V 24V		[B]	7 pol. ASS2 7 pin ASS2 ♂  1,50 m
		●	●					7 pol. ASS2 7 pin ASS2 ♀  0,30 m
33-8100-201	1/-	●	●	LED	12V 24V			offenes Ende open end 0,50 m
33-8100-701	1/-	●	●	LED	12V 24V			8 pol. Bajonett 8 pin Bayonet ♂  0,50 m
33-8107-031	1/-	●	●	LED	12V 24V			7 pol. ASS2 7 pin ASS2 ♂  0,50 m
33-9200-211	1/-	●	●	LED	12V 24V			offenes Ende open end 1,50 m
33-9200-521	1/-	●	●	LED	12V 24V			7 pol. ASS2 7 pin ASS2 ♂  1,50 m





# BRASPOINT 140

ZUBEHÖR / ACCESSORIES

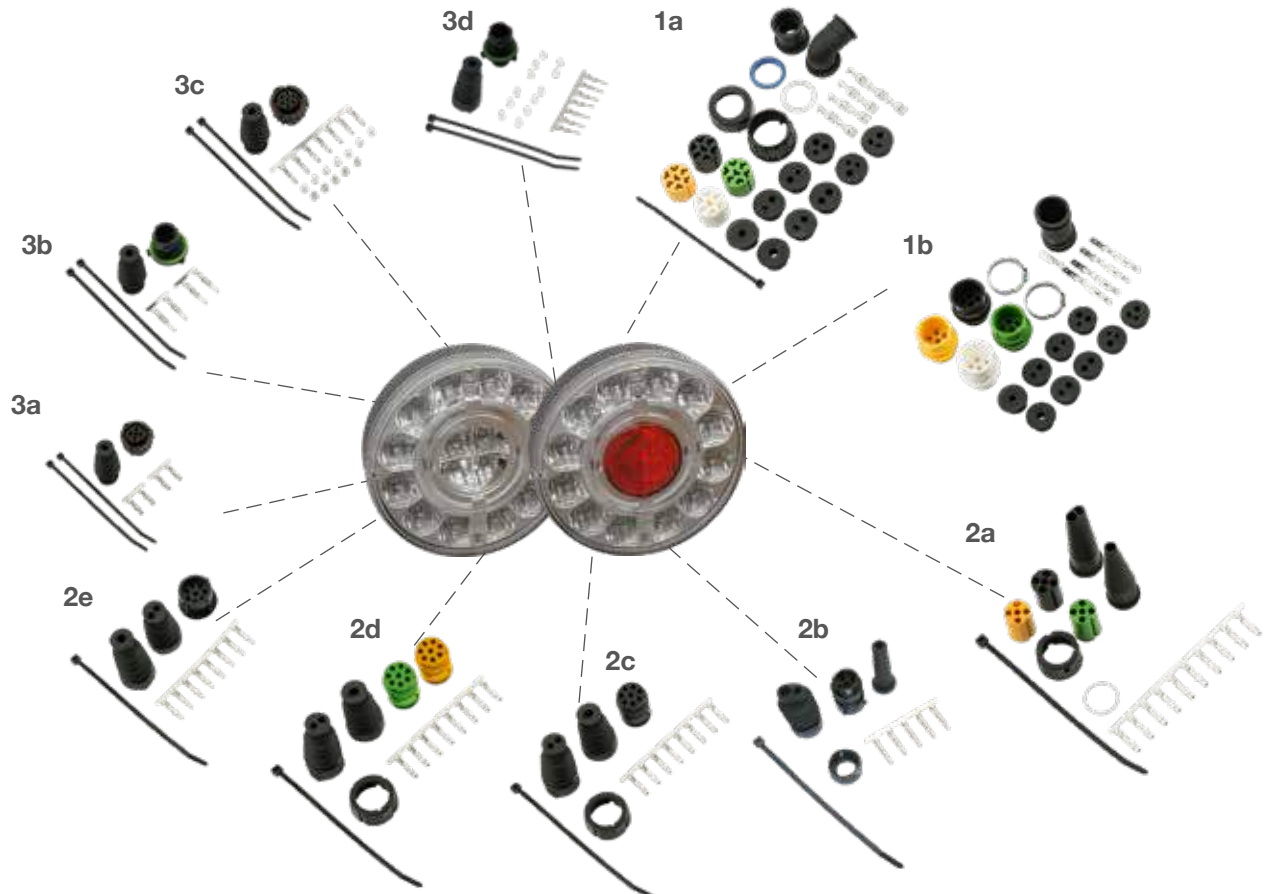

## 1 ASS1 & ASS2 Verbinder | ASS1 & ASS2 connector

- (a) 7 pol. weiblich  
7 pin female ..... 13-5626-631
- (b) 7 pol. männlich  
7 pin male ..... 13-5625-981

## 2 Bajonett Verbinder | bayonet connector

- (a) 5 pol. weiblich  
5 pin female ..... 13-0521-104
- (b) 5 pol. männlich  
5 pin male ..... 13-0536-044
- (c) 8 pol. weiblich  
8 pin female ..... 13-0828-034
- (d) 8 pol. weiblich  
8 pin female ..... 15-0821-524
- (e) 8 pol. männlich  
8 pin male ..... 13-0838-054

## 3 AMP Verbinder | AMP connector

- (a) 4 pol. weiblich  
4 pin female ..... 15-7002-004
- (b) 4 pol. männlich  
4 pin male ..... 15-7002-014
- (c) 7 pol. weiblich  
7 pin female ..... 15-7002-024
- (d) 7 pol. männlich  
7 pin male ..... 15-7002-034



# ROUNDPOINT II

ADR Zone 2 IP 6K9K



Produktinformation  
Product information

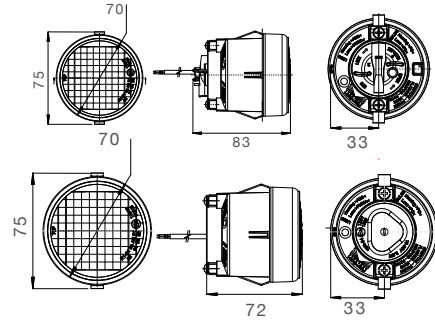

BEST. NR	PART NO	←	→	💡	⚡ 12V	🔍	ZUSATZ	ANSCHLUSS
ADD ON							CONNECTOR	
31-7600-001	1/-	●	●	💡	12V	🔍	↔	offenes Ende open end 1,80 m
32-7600-001	1/-	●	●	💡	12V	🔍	↔ (S)	offenes Ende open end 1,80 m
37-7600-001	1/-	●	●	💡	12V	🔍	⊕	offenes Ende open end 1,80 m
38-7600-001	1/-	●	●	💡	12V	🔍	⊖	offenes Ende open end 1,80 m



# ROUNDPOINT II LED

ZUBEHÖR / ACCESSORIES

ADR Zone 2 IP6K9K



Produktinformation  
Product information

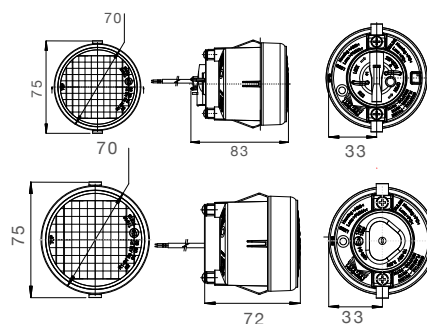

BEST. NR		←	→	LED	12V 24V	Light icon	ZUSATZ ADD ON	ANSCHLUSS CONNECTOR
31-7600-701	1/96	●	●	LED	12V 24V	Yellow lens icon	↔	offenes Ende open end 1,80 m
32-7600-701	1/96	●	●	LED	12V 24V	Red lens icon	↔ (a), (b)	offenes Ende open end 1,80 m
37-7600-701	1/96	●	●	LED	12V 24V	Red lens icon	↔ (c)	offenes Ende open end 1,80 m
38-7600-701	1/96	●	●	LED	12V 24V	Grey lens icon	↔ (d)	offenes Ende open end 1,80 m

ZUBEHÖR / ACCESSORIES

## 1 Lichtscheibe inklusive Gehäuse | lens including housing

- (a) ..... 21-7600-001
- (b) ..... 22-7600-001
- (c) ..... 27-7600-001
- (d) ..... 28-7600-001

## Glühlampe | bulb

- 12V 21W, BA15s ..... 16-6121-017
- 12V 21W / 5W ..... 16-6122-017





## 3 CHAMBER LAMP II LED

ADR  
Zone 2

IP 54

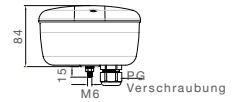
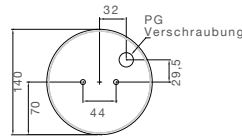
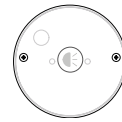
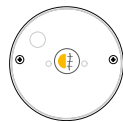
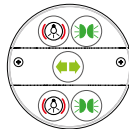
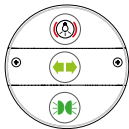

BEST. NR	Part No	Left	Right	Light	Voltage	Function	Function	Connector	Notes
22-7000-701	1/10	●	●	LED	12V 24V	Clear	Left, Right	PG 11 Verschraubung cable glands 11	
23-8400-751	1/10	●	●	LED	12V 24V	Red/Yellow	2x Left, 2x Right, Stop	PG 11 Verschraubung cable glands 11	
23-8400-761	1/-	●	●	LED	12V 24V	Red/Yellow	2x Left, 2x Right, Stop	PG 16 Verschraubung cable glands 16	
23-8400-771	1/-	●	●	LED	12V 24V	Red/Yellow	2x Left, 2x Right, Stop	8 pol. Bajonett 8 pin Bayonet	
23-8400-781	1/-	●	●	LED	12V 24V	Red/Yellow	2x Left, 2x Right, Stop	5 pol. Bajonett 5 pin Bayonet	
23-8400-801	1/10	●	●	LED	12V 24V	Red/Yellow	2x Left, 2x Right, Stop	PG 11 Verschraubung cable glands 11	
23-8400-811	1/10	●	●	LED	12V 24V	Red/Yellow	2x Left, 2x Right, Stop	PG16 Verschraubung cable glands 16	
23-8400-821	1/20	●	●	LED	12V 24V	Red/Yellow	2x Left, 2x Right, Stop	8 pol. Bajonett 8 pin Bayonet	
27-8100-721	1/-	●	●	LED	12V 24V	Red	Left, Right	8 pol. Bajonett 8 pin Bayonet	
27-8400-701	1/10	●	●	LED	12V 24V	Red	Left, Right	PG 11 Verschraubung cable glands 11	
28-8100-731	1/20	●	●	LED	12V 24V	Clear	Left, Right	8 pol. Bajonett 8 pin Bayonet	
28-8400-701	1/-	●	●	LED	12V 24V	Clear	Left, Right	PG 11 Verschraubung cable glands 11	
32-7000-701	1/10	●	●	LED	12V 24V	Clear	Left, Right	7 pol. ASS2 7 pin ASS2	1,50 m
33-8400-011	1/-	●	●	LED	12V 24V	Red/Yellow	2x Left, 2x Right, Stop	offnes Ende open end	2,50 m
33-8402-031	1/10	●	●	LED	12V 24V	Red/Yellow	2x Left, 2x Right, Stop	offnes Ende open end	0,50 m
33-8403-031	1/10	●	●	LED	12V 24V	Red/Yellow	2x Left, 2x Right, Stop	offnes Ende open end	0,50 m



### 3 CHAMBER LAMP II LED

ADR Zone 2

IP 54

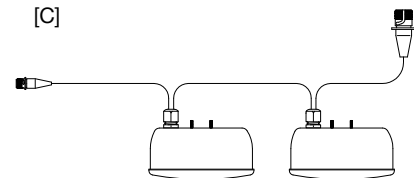
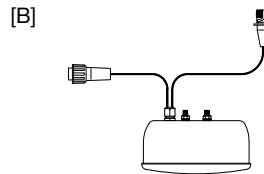
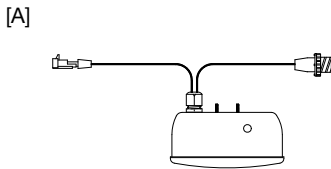

BEST. NR PART NO	Box	←	→	LED	V	Color	FUNKTION	ANSCHLUSS		
							FUNCTION	CONNECTOR	Length	Symbol
33-8403-041	1/-	●		LED	12V 24V			offnes Ende open end	0,50 m	
33-8405-081	1/-	●		LED	12V 24V		2x	7 pol. ASS2 7 pin ASS2	0,50 m	
33-8405-091	1/-	●		LED	12V 24V			7 pol. ASS2 7 pin ASS2	0,50 m	
33-8405-101	1/20	●		LED	12V 24V			7 pol. AMP 7 pin AMP	0,90 m	
								2 pol. Superseal 2 pin Superseal	1,00 m	
33-8406-081	1/10		●	LED	12V 24V		2x	7 pol. ASS2 7 pin ASS2	0,50 m	
33-8406-091	1/-		●	LED	12V 24V			7 pol. ASS2 7 pin ASS2	0,50 m	
33-8406-101	1/20		●	LED	12V 24V		[A]	7 pol. AMP 7 pin AMP	0,90 m	
								2 pol. Superseal 2 pin Superseal	1,00 m	
33-8407-014	1/20	●	●	LED	12V 24V		[B]	7 pol. ASS2 7 pin ASS2	0,15 m	
								7 pol. ASS2 7 pin ASS2	0,15 m	
37-8400-001	1/10	●	●	LED	12V 24V			2 pol. Superseal 2 pin Superseal	0,55 m	
37-8407-001	1/-	●	●	LED	12V 24V			2 pol. ASS2 2 pin ASS2	1,50 m	
38-8107-061	1/-	●	●	LED	12V 24V			7 pol. ASS2 7 pin ASS2	0,15 m	
38-8407-001	1/-	●	●	LED	12V 24V			2 pol. ASS2 2 pin ASS2	1,50 m	
39-7000-001	1/-	●	●	LED	12V 24V			3 pol. AMP 3 pin AMP	0,58 m	
39-7007-001	1/10	●	●	LED	12V 24V			7 pol. ASS2 7 pin ASS2	0,15 m	
87-3079-001	1/-	●		LED	12V 24V		[C]	7 pol. AMP 7 pin AMP	0,90 m	
								2 pol. Superseal 2 pin Superseal	1,00 m	
87-3080-001	1/-		●	LED	12V 24V		[C]	7 pol. AMP 7 pin AMP	0,90 m	
								2 pol. Superseal 2 pin Superseal	1,00 m	



# 3 CHAMBER LAMP II LED

ZUBEHÖR / ACCESSORIES

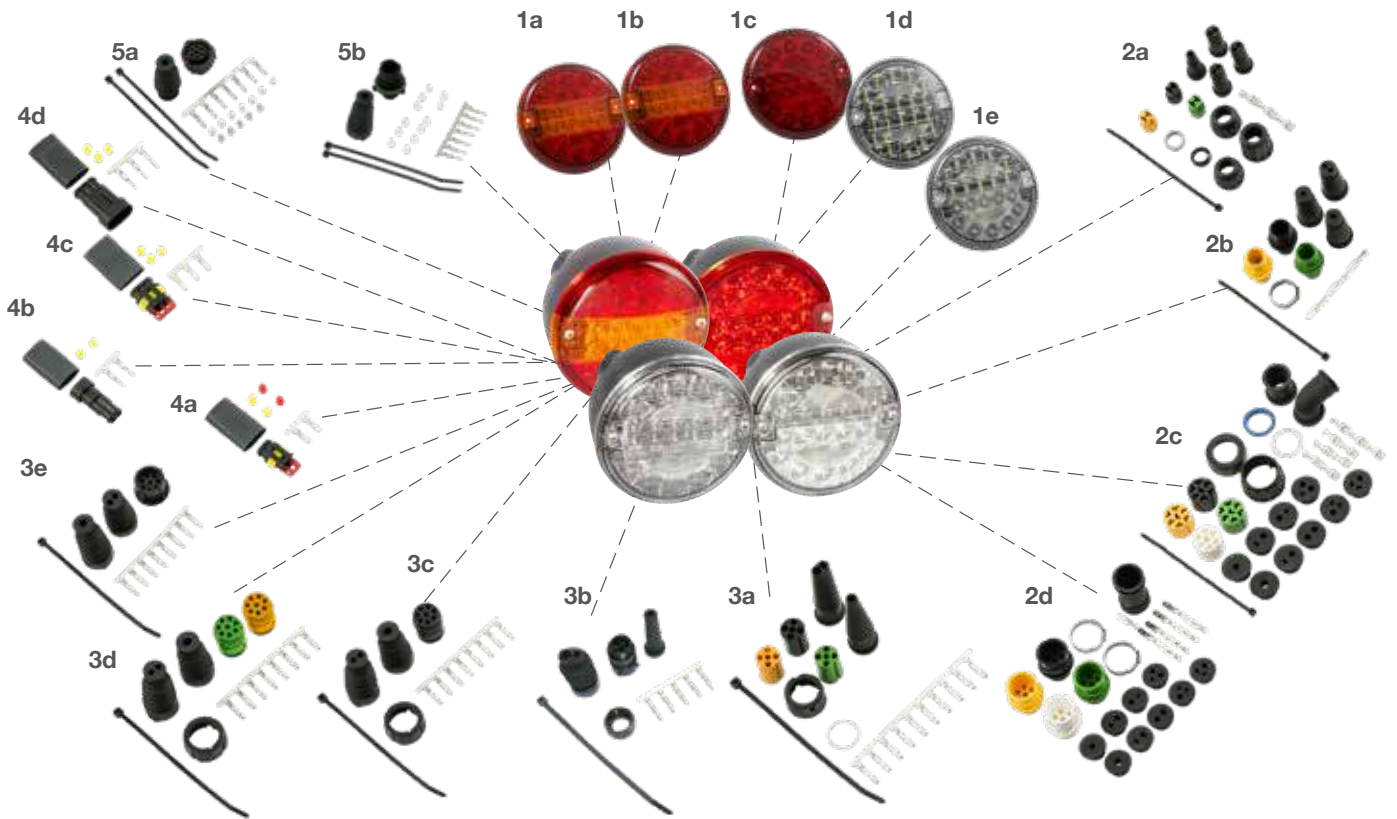

- 1 Lichtscheibe | lens**
- (a) 3 Kammerleuchte Doppelfunktion  
3 Chamber double function  
..... 18-8384-501
  - (b) 3 Kammerleuchte Einfunktion  
3 chamber single function  
..... 18-8384-551
  - (c) mit   
with ..... 18-8784-501
  - (d) mit   
with ..... 18-8884-501
  - (e) mit   
with ..... 22-7000-001

- 2 ASS1 & ASS2 Verbinder | ASS1 & ASS2 connector**
- (a) 2 pol. weiblich  
2 pin female ..... 13-5626-401
  - (b) 2 pol. männlich  
2 pin male ..... 13-5625-991
  - (c) 7 pol. weiblich  
7 pin female ..... 13-5626-631
  - (d) 7 pol. männlich  
7 pin male ..... 13-5625-981

- 3 Bajonett Verbinder | bayonet connector**
- (a) 5 pol. weiblich  
5 pin female ..... 13-0521-104

- (b) 5 pol. männlich  
5 pin male ..... 13-0536-044
- (c) 8 pol. weiblich  
8 pin female ..... 13-0828-034
- (d) 8 pol. weiblich  
8 pin female ..... 15-0821-524
- (e) 8 pol. männlich  
8 pin male ..... 13-0838-054

- 4 Superseal Verbinder | Superseal connector**
- (a) 2 pol. weiblich  
2 pin female ..... 15-7002-044
  - (b) 2 pol. männlich  
2 pin male ..... 15-7002-054
  - (c) 3 pol. weiblich  
3 pin female ..... 15-7002-064
  - (d) 3 pol. männlich  
3 pin male ..... 15-7002-074

- 5 AMP Verbinder | AMP connector**
- (a) 7 pol. weiblich  
7 pin female ..... 15-7002-024
  - (b) 7 pol. männlich  
7 pin male ..... 15-7002-034



# 3 CHAMBER LAMP I LED

ADR  
Zone 2

IP 54

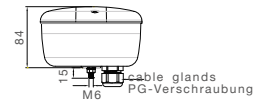
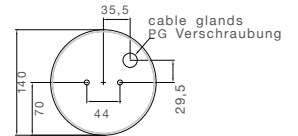
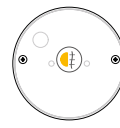
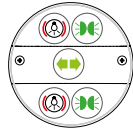
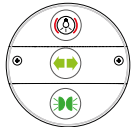

BEST. NR		←	→	LED	24V		FUNKTION	ANSCHLUSS
PART NO							FUNCTION	CONNECTOR
23-8400-711	1/-	●	●	LED	24V			PG 16 Verschraubung cable glands 16
23-8400-721	1/10	●	●	LED	24V			PG 11 Verschraubung cable glands 11
23-8500-701	1/-	●	●	LED	24V		2x  2x	8 pol. Bajonett 8 pin Bayonet
23-8500-721	1/10	●	●	LED	24V		2x  2x	PG 11 Verschraubung cable glands 11
27-8100-701	1/10	●	●	LED	24V			PG 9 Verschraubung cable glands 9
28-8100-711	1/10	●	●	LED	24V			PG 9 Verschraubung cable glands 9

## ZUBEHÖR / ACCESSORIES

- 1** Bajonett Verbinder | bayonet connector  
8 pol. weiblich  
8 pin female ..... 13-0828-034





# 3 CHAMBER LAMP

ADR  
Zone 2

IP 54

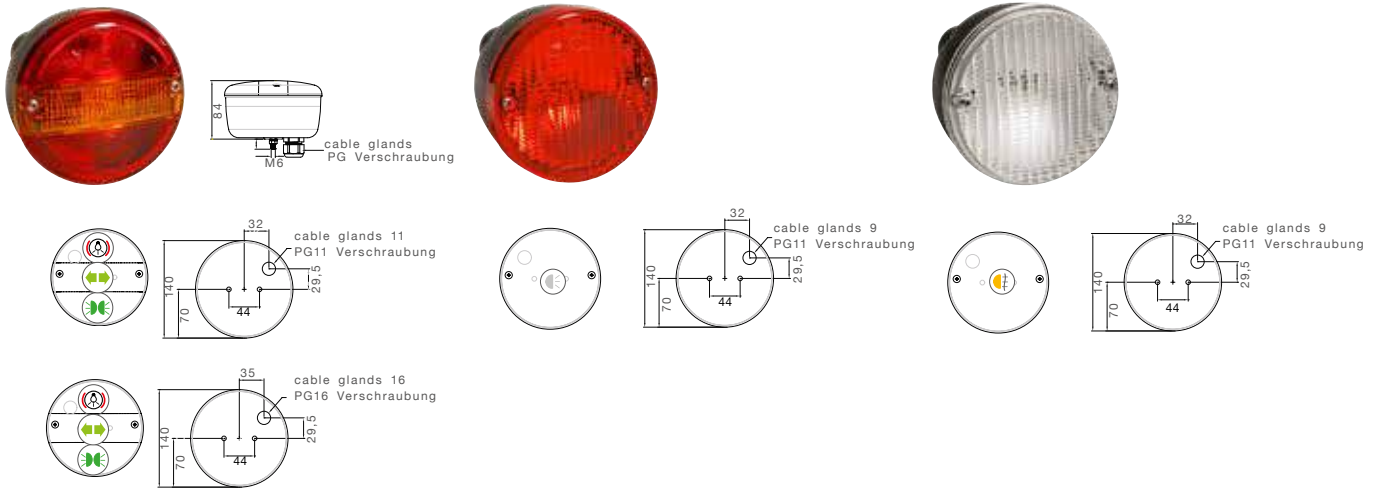

BEST. NR	PART NO	←	→	⚡	V	FUNKTION	FUNCTION	ANSCHLUSS	CONNECTOR
23-8200-011	1/10	●	●	💡	24V			PG 11 Verschraubung cable glands 11	
23-8200-511	1/10	●	●	💡	24V			8 pol. Bajonett 8 pin Bayonet	
23-8220-001	1/20	●	●	💡	24V			18,5 mm Loch 18,5 mm hole	
23-8230-001	1/-	●	●	💡	24V			PG 16 Verschraubung cable glands 16	
27-8000-021	1/10	●	●	💡	24V			PG 9 Verschraubung cable glands 9	
27-8001-511	1/-	●	●	💡	24V			8 pol. Bajonett 8 pin Bayonet	
28-8000-021	1/10	●	●	💡	24V			PG 9 Verschraubung cable glands 9	
28-8001-521	1/20	●	●	💡	24V			8 pol. Bajonett 8 pin Bayonet	
33-8205-031	-/-	●		💡	24V		[A]	7 pol. ASS2 7 pin ASS2	♂
								7 pol. ASS2 7 pin ASS2	♀
33-8205-081	1/10	●		💡	24V			7 pol. ASS2 7 pin ASS2	♀
33-8205-101	1/-	●		💡	24V		[B]	7 pol. AMP 7 pin AMP	♂
								2 pol. Superseal 2 pin Superseal	♂
33-8206-031	-/-		●	💡	24V		[A]	7 pol. ASS2 7 pin ASS2	♂
								7 pol. ASS2 7 pin ASS2	♀
33-8206-091	1/10		●	💡	24V			7 pol. ASS2 7 pin ASS2	♀
33-8206-101	1/-		●	💡	24V		[B]	7 pol. AMP 7 pin AMP	♂
								2 pol. Superseal 2 pin Superseal	♂





# 3 CHAMBER LAMP

ADR  
Zone 2

IP 54

[A]

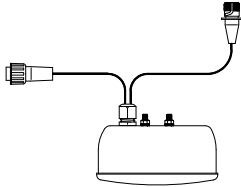

[B]

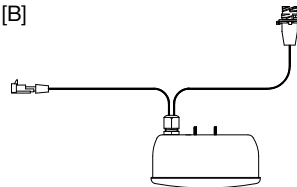

BEST. NR PART NO		←	→				FUNKTION	ANSCHLUSS	
							FUNCTION	CONNECTOR	
37-8000-041	-/-	●	●		24V			2 pol. Superseal 2 pin Superseal ♀	0,25 m
37-8000-061	-/-	●	●		24V			2 pol. Superseal 2 pin Superseal ♀	1,60 m
37-8007-131	1/-	●	●		24V			2 pol. ASS2 2 pin ASS2 ♀	0,25 m
37-8007-161	-/-	●	●		24V			2 pol. ASS2 2 pin ASS2 ♀	1,20 m
37-8007-191	1/-	●	●		24V			2 pol. ASS2 2 pin ASS2 ♀	3,00 m
38-8000-031	-/-	●	●		24V			2 pol. Superseal 2 pin Superseal ♂	0,25 m
38-8000-051	-/-	●	●		24V			2 pol. Superseal 2 pin Superseal ♀	0,25 m
38-8000-061	-/-	●	●		24V			2 pol. Superseal 2 pin Superseal ♀	1,60 m
38-8007-131	1/-	●	●		24V			2 pol. ASS2 2 pin ASS2 ♀	0,25 m
38-8007-141	-/-	●	●		24V			2 pol. ASS2 2 pin ASS2 ♀	3,00 m
38-8007-151	-/-	●	●		24V			2 pol. ASS2 2 pin ASS2 ♀	1,20 m



# 3 CHAMBER LAMP

ADR Zone 2

IP 54

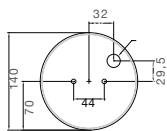
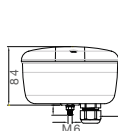

[A]

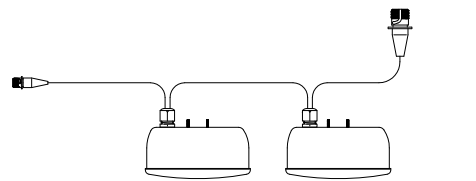

[B]

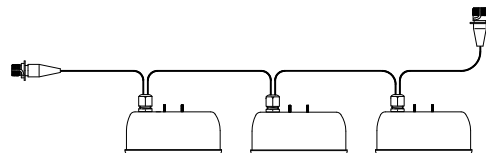

Blinklicht Direction indicator	Rücklicht Tail light	Bremslicht Stop light	

BEST. NR PART NO		←	→				ZUSATZ	ANSCHLUSS
							ADD ON	CONNECTOR
87-3047-021	1/-		●		24V		[A] 7 pol. ASS2 7 pin ASS2 2 pol. ASS2 2 pin ASS2	 0,90 m 1,00 m
87-3048-021	1/-	●			24V		[A] 7 pol. ASS2 7 pin ASS2 2 pol. ASS2 2 pin ASS2	 0,90 m 1,00 m
87-3067-001	-/-		●		24V		[B] 7 pol. ASS2 7 pin ASS2 2 pol. ASS2 2 pin ASS2	 0,90 m 1,00 m
87-3068-001	-/-	●			24V		[B] 7 pol. ASS2 7 pin ASS2 2 pol. ASS2 2 pin ASS2	 0,90 m 1,00 m
87-3081-001	1/-	●			24V		[B] 7 pol. AMP 7 pin AMP 2 pol. Superseal 2 pin Superseal	 0,90 m 1,00 m
87-3082-001	1/-		●		24V		[B] 7 pol. AMP 7 pin AMP 2 pol. Superseal 2 pin Superseal	 0,90 m 1,00 m



# 3 CHAMBER LAMP

ZUBEHÖR / ACCESSORIES

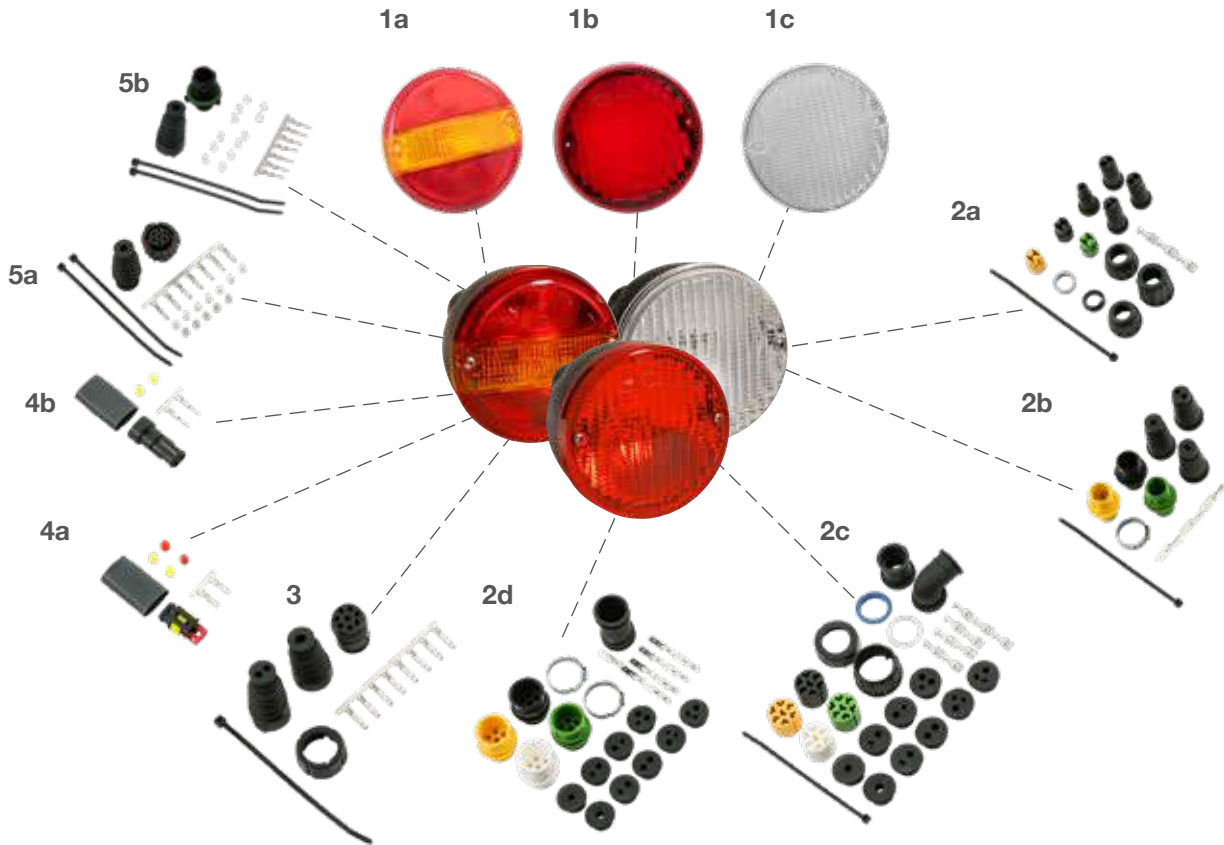

## 1 Lichtscheibe | lens

- (a) 3 Kammerleuchte  
3 chamber lamp..... 18-8382-104
- (b) mit   
with ..... 18-8780-104
- (c) mit   
with ..... 18-8880-104

## 2 ASS1 & ASS2 Verbinder | ASS1 & ASS2 connector

- (a) 2 pol. weiblich  
2 pin female ..... 13-5626-401
- (b) 2 pol. männlich  
2 pin male ..... 13-5625-991
- (c) 7 pol. weiblich  
7 pin female ..... 13-5626-631
- (d) 7 pol. männlich  
7 pin male ..... 13-5625-981

## 3 Bajonett Verbinder | bayonet connector

- 8 pol. weiblich  
8 pin female ..... 13-0828-034

## 4 Superseal Verbinder | Superseal connector

- (a) 2 pol. weiblich  
2 pin female ..... 15-7002-044
- (b) 2 pol. männlich  
2 pin male ..... 15-7002-054

## 5 AMP Verbinder | AMP connector

- (a) 7 pol. weiblich  
7 pin female ..... 15-7002-024
- (b) 7 pol. männlich  
7 pin male ..... 15-7002-034



# AGRILED I



Produktinformation  
Product information

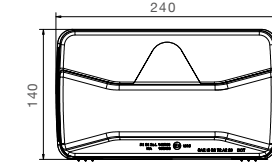
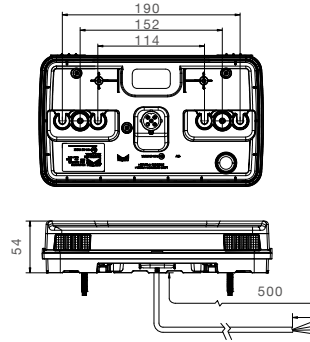

Blinklicht Direction indicator	Rücklicht Tail light	Bremslicht Stop light	Dreieckrückstrahler Triangle reflector

BEST. NR PART NO						ZUSATZ ADD ON	ANSCHLUSS CONNECTOR
23-4124-021	1/-	●	●	LED	12V		5 pol. Bajonett 5 pin Bayonet
23-4124-031	1/-	●	●	LED	12V		5 pol. Bajonett 5 pin Bayonet
23-4124-061	1/-	●	●	LED	12V		5 pol. Bajonett 5 pin Bayonet
23-4124-071	1/-	●	●	LED	12V		5 pol. Bajonett 5 pin Bayonet
33-4114-001	1/-	●	●	LED	12V		5 pol. Bajonett 5 pin Bayonet  1,50 m
33-4124-071	1/-	●	●	LED	12V		offenes Ende open end 0,50 m



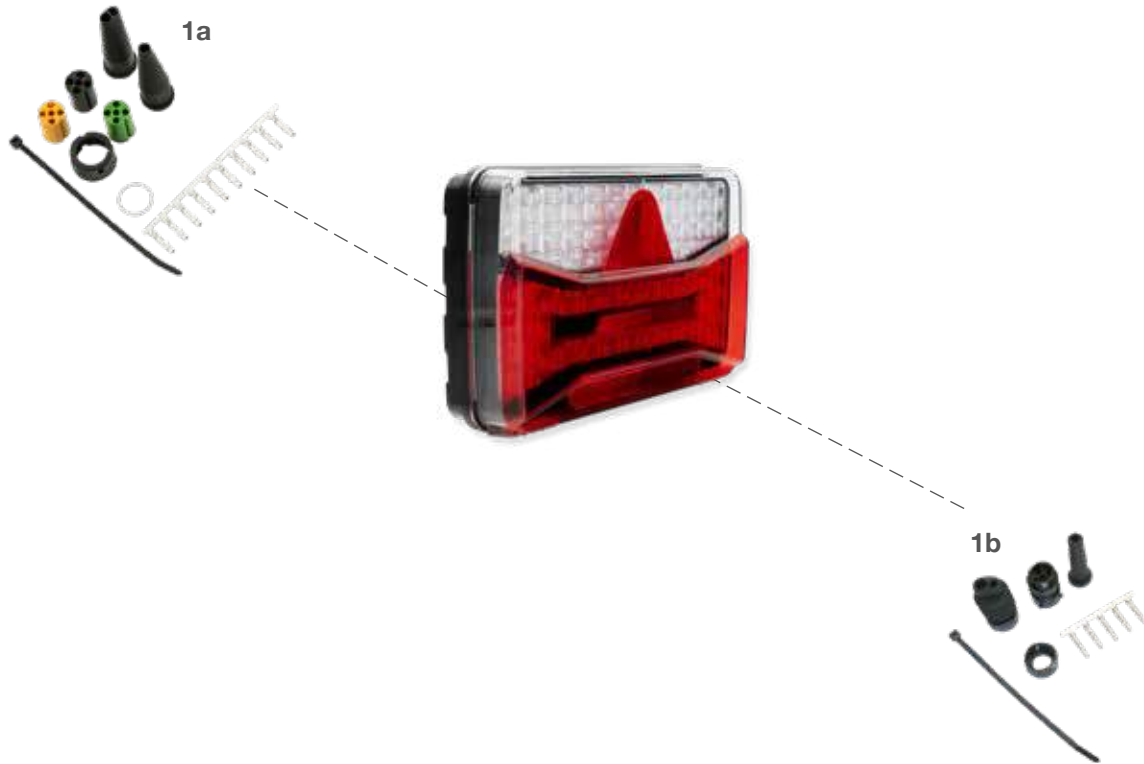

## AGRILED I

ZUBEHÖR / ACCESSORIES



### 1 Bajonett Verbinder | bayonet connector

- (a) 5 pol. weiblich  
5 pin female ..... 13-0521-104 
- (b) 5 pol. männlich  
5 pin male ..... 13-0536-044 



# AGRILED II

ADR Zone 2 IP 6K9K



Produktinformation  
Product information

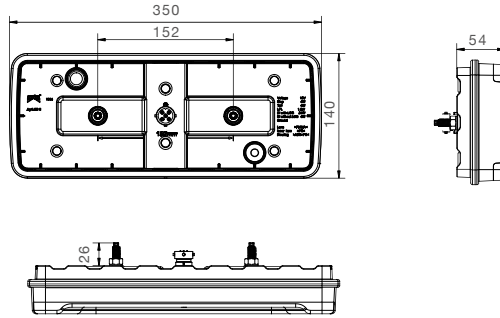

Blinklicht Direction indicator	Rücklicht Tail light	Bremslicht Stop light	Dreieckrückstrahler Triangle reflector

BEST. NR	PART NO		←	→			ZUSATZ ADD ON	ANSCHLUSS CONNECTOR
23-4124-211	1/-	●	●	LED	12V		5 pol. Bajonett 5 pin Bayonet	
23-4124-231	1/-	●	●	LED	12V		5 pol. Bajonett 5 pin Bayonet	
33-4124-241	1/-	●		LED	12V		7 pol. ASS2 7 pin ASS2	
33-4124-251	1/-	●		LED	12V		7 pol. ASS2 7 pin ASS2	
33-4124-271	1/-		●	LED	12V		7 pol. ASS2 7 pin ASS2	
33-4124-261	1/-		●	LED	12V		7 pol. ASS2 7 pin ASS2	



# AGRILED II

ZUBEHÖR / ACCESSORIES

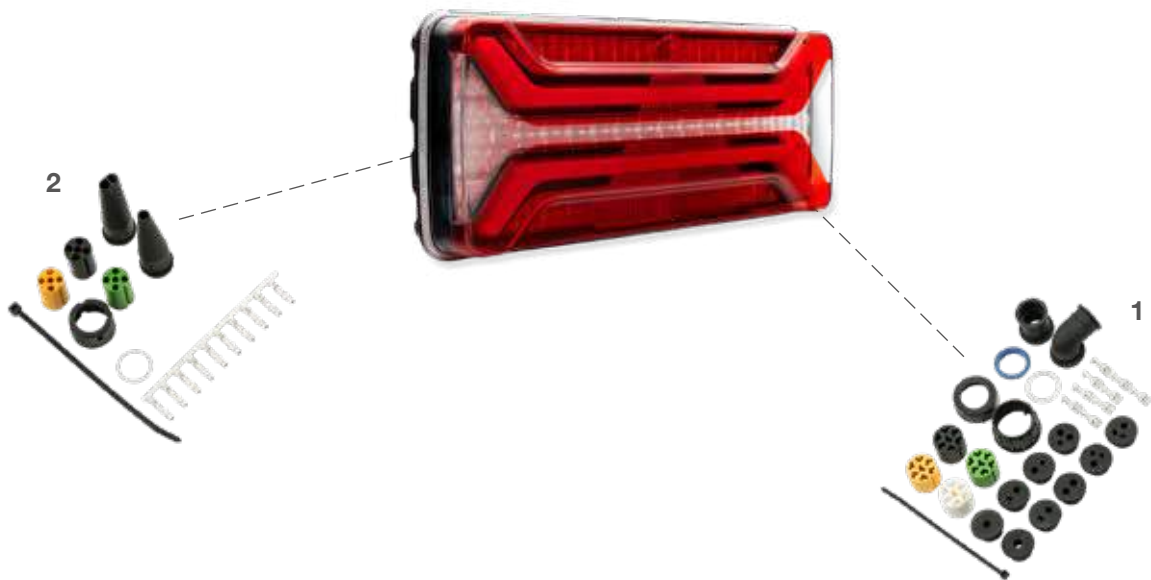

- 1** **ASS2 Verbinder | ASS2 connector**  
7 pol. weiblich  
7 pin. female ..... 13-5626-631
  
- 2** **Bajonett Verbinder | bayonet connector**  
5 pol. weiblich  
5 pin female ..... 13-0521-104



# AGRIPOINT

ADR Zone 2 IP6K9K



Produktinformation  
Product information

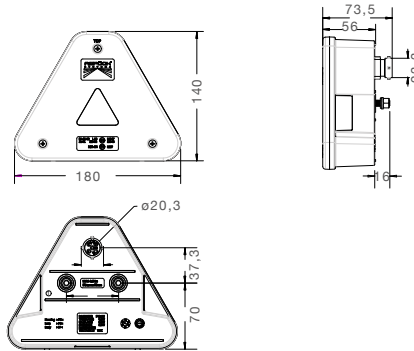

Blinklicht Direction indicator	Rücklicht Tail light	Bremslicht Stop light	Dreieckrückstrahler Triangle reflector

BEST. NR PART NO						ZUSATZ ADD ON	ANSCHLUSS CONNECTOR
23-4004-501	1/20	●	●		12V		5 pol. Bajonett 5 pin Bayonet
23-4004-531	1/20	●	●		12V		5 pol. Bajonett 5 pin Bayonet
23-4004-001	1/20	●	●		12V		offenes Ende open end 0,50 m
23-4004-031	1/20	●	●		12V		offenes Ende open end 0,50 m
23-4000-501	1/20	●	●		12V		5 pol. ASS2 5 pin ASS2
23-4000-531	1/20	●	●		12V		5 pol. ASS2 5 pin ASS2
23-4000-001	1/20	●	●		12V		offenes Ende open end 0,50 m
23-4000-031	1/20	●	●		12V		offenes Ende open end 0,50 m





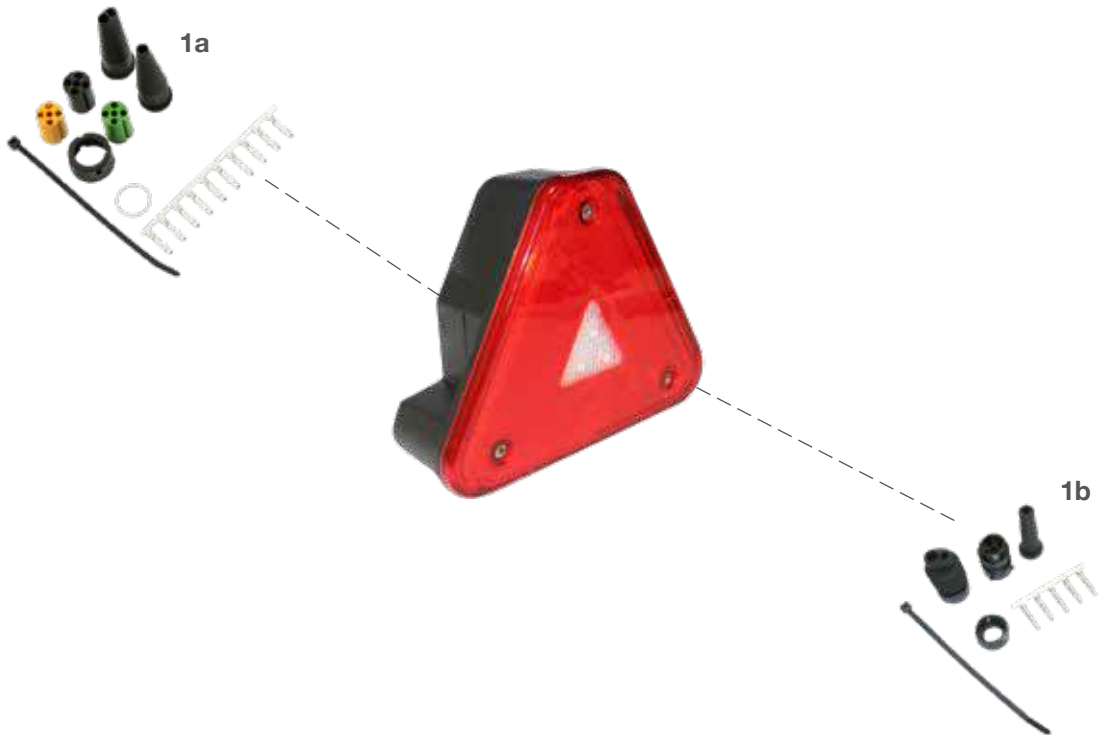

# AGRIPOINT

ZUBEHÖR / ACCESSORIES



## 1 Bajonett Verbinder | bayonet connector

- (a) 5 pol. weiblich  
5 pin female ..... 13-0521-104 
- (b) 5 pol. männlich  
5 pin male ..... 13-0536-044 



# MINILED III

ADR Zone 2 IP6K9K



Produktinformation  
Product information

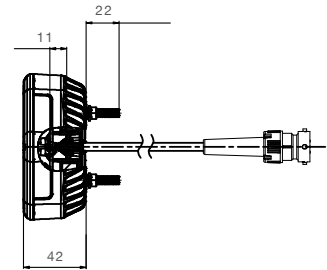
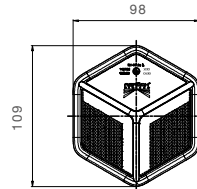

Blinklicht Direction indicator	Rücklicht Tail light	Bremslicht Stop light	

BEST. NR		←	→			ZUSATZ	ANSCHLUSS
PART NO						ADD ON	CONNECTOR
33-7234-001	1/-	●	●	LED	12V		5 pol. Bajonett 5 pin Bayonet   0,50 m
33-7234-011	1/-	●	●	LED	12V		5 pol. Bajonett 5 pin Bayonet   0,50 m
33-7234-071	1/-	●	●	LED	12/24V		5 pol. Bajonett 5 pin Bayonet   0,50 m
33-7234-081	1/-	●	●	LED	12/24V		5 pol. Bajonett 5 pin Bayonet   0,50 m
33-7234-021	1/-	●	●	LED	12V		offenes Ende open end 0,50 m
33-7234-031	1/-	●	●	LED	12V		offenes Ende open end 0,50 m
33-7234-051	1/-	●	●	LED	12/24V		offenes Ende open end 0,50 m
33-7234-061	1/-	●	●	LED	12/24V		offenes Ende open end 0,50 m
33-7234-041	1/-	●	●	LED	12/24V		offenes Ende open end 0,50 m



## MINILED III

ZUBEHÖR / ACCESSORIES

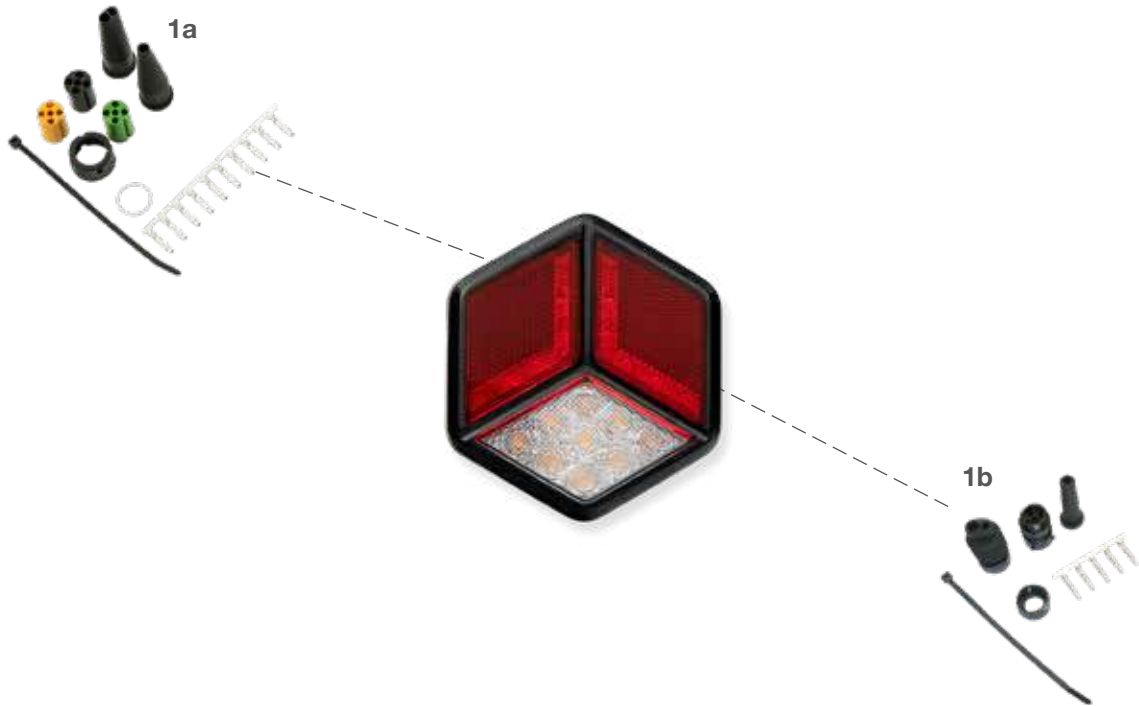

### 1 Bajonett Verbinder | bayonet connector

- (a) 5 pol. weiblich  
5 pin female ..... 13-0521-104
- (b) 5 pol. männlich  
5 pin male ..... 13-0536-044

# FASTBOOK<sup>®</sup>

## SYSTEMS



## UMRISSLEUCHE

Um eine flexible und optimale Anbringung zu ermöglichen, bieten wir unsere Umrissleuchten mit verschiedenen Befestigungswinkeln an. Somit wird die Begrenzung des Fahrzeuges sichtbar gemacht und mehr Sicherheit garantiert.

## END OUTLINE MARKER

In order to allow a flexible and optimal mounting, we offer our end outline marker lamps with various mounting brackets. Thus, the boundary of the vehicle is made visible and more safety is guaranteed.

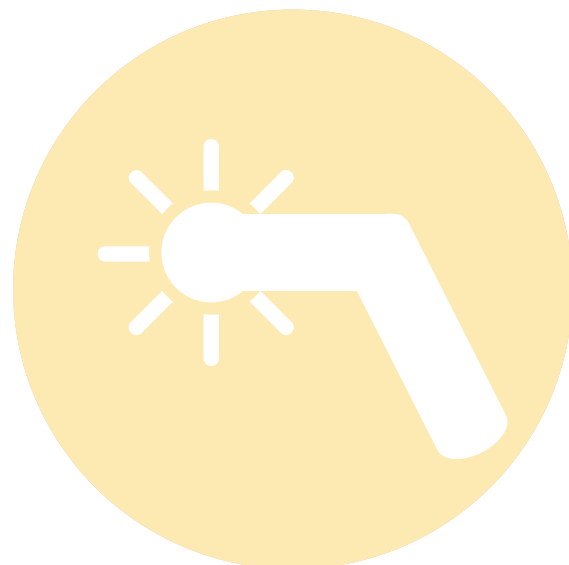



# SUPERPOINT IV LED

ADR Zone 2 IP69K



Produktinformation  
Product information

[A1]

[A2]

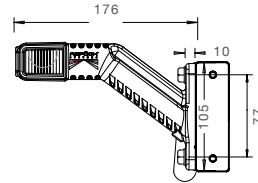
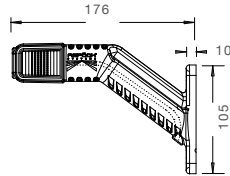

Umrissleuchte  
End outline marker

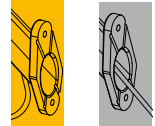

BEST. NR						ZUSATZ	ANSCHLUSS	
PART NO						ADD ON	CONNECTOR	
31-3104-004	1/30	●		LED	12V 24V	[A1]	P&R	2,00 m
31-3105-004	1/10	●		LED	12V 24V	[A1]	2 pol. ASS2 2 pin ASS2	♀   2,00 m
31-3103-034	1/20	●		LED	12V 24V	[A1]	2 pol. Superseal 2 pin Superseal	♀   1,00 m
31-3104-014	1/50		●	LED	12V 24V	[A1]	P&R	2,00 m
31-3106-004	1/10		●	LED	12V 24V	[A1]	2 pol. ASS2 2 pin ASS2	♀   2,00 m
31-3102-034	1/20		●	LED	12V 24V	[A1]	2 pol. Superseal 2 pin Superseal	♀   1,00 m
31-3103-024	1/10	●		LED	12V 24V	[A1]	offenes Ende mit Flachsteckern open end with contact pin	0,25 m
31-3102-024	1/25		●	LED	12V 24V	[A1]	Europoint III offenes Ende mit Flachsteckern open end with contact pin	0,25 m
31-3100-004	1/10	●		LED	12V 24V	[A1]	P&R	2,00 m
			●			[A1]	P&R	2,00 m
31-3103-104	1/-	●		LED	12V 24V	[A1]	offenes Ende open end	0,25 m
31-3103-114	1/-	●		LED	12V 24V	[A1]	offenes Ende open end	2,00 m
31-3103-124	1/-	●		LED	12V 24V	[A1]	2 pol. Superseal 2 pin Superseal	♂   2,00 m
31-3103-184	1/-	●		LED	12V 24V	[A1]	P&R	2,00 m
31-3103-204	1/-	●		LED	12V 24V	[A1]	2 pol. ASS2 2 pin ASS2	♀   0,25 m
31-3103-214	1/-	●		LED	12V 24V	[A1]	Ecoled II 2 pol. Superseal 2 pin Superseal	♀   0,25 m
31-3104-034	1/-	●		LED	12V 24V	[A1]	Ecoled II P&R	0,50 m
31-3105-014	1/-	●		LED	12V 24V	[A1]	2 pol. ASS2 2 pin ASS2	♀   0,50 m



# SUPERPOINT IV LED

ADR Zone 2

IP69K



Produktinformation  
Product information

[A1]

[A2]

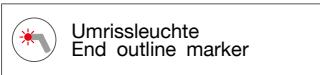
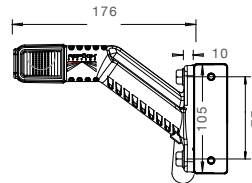
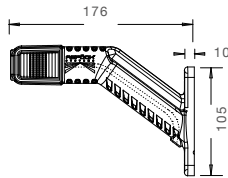

Umrissleuchte  
End outline marker

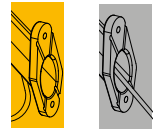

BEST. NR						ZUSATZ	ANSCHLUSS				
PART NO		←	→	LED	12V 24V	ADD ON	CONNECTOR				
31-3105-024	1/-	●		LED	12V 24V	[A1]		2 pol. ASS3 2 pin ASS3	♀	1,50 m	
31-3105-034	1/-	●		LED	12V 24V	[A1]		2 pol. ASS2 2 pin ASS2	♀	2,00 m	
31-3105-044	1/-	●		LED	12V 24V	[A1]		2 pol. ASS2 2 pin ASS2	♀	0,75 m	
31-3164-004	1/50	●		LED	12V 24V	[A2]		P&R		0,75 m	
31-3165-004	1/40	●		LED	12V 24V	[A2]		2 pol. ASS2 2 pin ASS2	♀	1,50 m	
31-3102-104	1/-		●	LED	12V 24V	[A1]		offenes Ende open end		0,25 m	
31-3102-114	1/-		●	LED	12V 24V	[A1]		offenes Ende open end		2,00 m	
31-3102-124	1/-		●	LED	12V 24V	[A1]		2 pol. Superseal 2 pin Superseal	♂	2,00 m	
31-3102-184	1/-		●	LED	12V 24V	[A1]		P&R		2,00 m	
31-3102-204	1/-		●	LED	12V 24V	[A1]		2 pol. ASS2 2 pin ASS2	♀	0,25 m	
31-3102-214	1/-		●	LED	12V 24V	[A1]		Ecoled II 2 pol. Superseal 2 pin Superseal	♀	0,25 m	
31-3104-024	1/-		●	LED	12V 24V	[A1]		P&R		0,50 m	
31-3106-014	1/-		●	LED	12V 24V	[A1]		2 pol. ASS2 2 pin ASS2	♀	0,50 m	
31-3106-024	1/-		●	LED	12V 24V	[A1]		2 pol. ASS3 2 pin ASS3	♀	1,50 m	
31-3106-034	1/-		●	LED	12V 24V	[A1]		2 pol. ASS2 2 pin ASS2	♀	2,00 m	
31-3106-044	1/-		●	LED	12V 24V	[A1]		2 pol. ASS2 2 pin ASS2	♀	0,75 m	
31-3164-014	1/50		●	LED	12V 24V	[A2]		P&R		0,75 m	
31-3166-004	1/50		●	LED	12V 24V	[A2]		2 pol. ASS2 2 pin ASS2	♀	1,50 m	



# SUPERPOINT IV LED

ADR Zone 2 IP69K



Produktinformation  
Product information

[B]

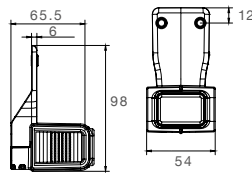

[C]

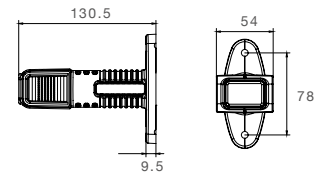

Umrissleuchte  
End outline marker

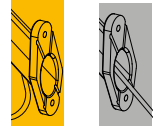

BEST. NR						ZUSATZ				ANSCHLUSS	
PART NO				LED	12V 24V	ADD ON				CONNECTOR	
31-3103-064	1/-	●		LED	12V 24V	[B]				offenes Ende open end	2,00 m
31-3103-144	1/-	●		LED	12V 24V	[C]				offenes Ende open end	2,00 m
31-3103-194	1/-	●		LED	12V 24V	[B]				2 pol. ASS3 2 pin ASS3	2,00 m
31-3104-084	1/-	●		LED	12V 24V	[B]				P&R	2,00 m
31-3102-064	1/-		●	LED	12V 24V	[B]				offenes Ende open end	2,00 m
31-3102-144	1/-		●	LED	12V 24V	[B]				offenes Ende open end	2,00 m
31-3102-194	1/-		●	LED	12V 24V	[B]				2 pol. ASS3 2 pin ASS3	2,00 m
31-3104-094	1/-		●	LED	12V 24V	[B]				P&R	2,00 m
31-3103-074	1/-	●		LED	12V 24V	[C]				offenes Ende open end	2,00 m
31-3103-134	1/-	●		LED	12V 24V	[C]				P&R	2,00 m
31-3103-154	1/-	●		LED	12V 24V	[D]				offenes Ende open end	2,00 m
31-3104-044	1/-	●		LED	12V 24V	[C]				P&R	2,00 m
31-3102-074	1/-		●	LED	12V 24V	[C]				offenes Ende open end	2,00 m
31-3102-134	1/-		●	LED	12V 24V	[C]				P&R	2,00 m
31-3102-154	1/-		●	LED	12V 24V	[C]				offenes Ende open end	2,00 m
31-3104-054	1/-		●	LED	12V 24V	[C]				P&R	2,00 m





# SUPERPOINT IV LED

ADR  
Zone 2

IP69K

Umrissleuchte  
End Outline  
Marker



Produktinformation  
Product information

[D]

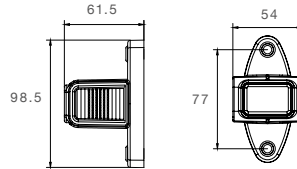

Umrissleuchte  
End outline marker

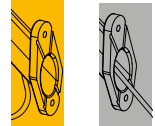

BEST. NR PART NO	Box	←	→	LED	12V 24V	ZUSATZ ADD ON			ANSCHLUSS CONNECTOR		
						[D]	Color	Mounting	Connector	Length	End
31-3103-044	1/-	●		LED	12V 24V	[D]	Red/White	Mounting	offenes Ende open end	2,00 m	↔
31-3103-164	1/-	●		LED	12V 24V	[B]	Red/White	Mounting	offenes Ende open end	2,00 m	↔
31-3104-104	1/-	●		LED	12V 24V	[D]	Red/White	Mounting	offenes Ende open end	4,50 m	↔
31-3104-114	1/-	●		LED	12V 24V	[D]	Red/White	Mounting	P&R	4,50 m	↔
31-3104-064	1/-	●		LED	12V 24V	[D]	Red/White	Mounting	P&R	2,00 m	↔
31-3102-044	1/-		●	LED	12V 24V	[D]	Red/White	Mounting	offenes Ende open end	2,00 m	↔
31-3102-164	1/-		●	LED	12V 24V	[D]	Red/White	Mounting	offenes Ende open end	2,00 m	↔
31-3104-124	1/-		●	LED	12V 24V	[D]	Red/White	Mounting	P&R	4,50 m	↔
31-3104-134	1/-		●	LED	12V 24V	[D]	Red/White	Mounting	offenes Ende open end	4,50 m	↔
31-3104-074	1/-		●	LED	12V 24V	[D]	Red/White	Mounting	P&R	2,00 m	↔



# SUPERPOINT IV LED

ZUBEHÖR / ACCESSORIES

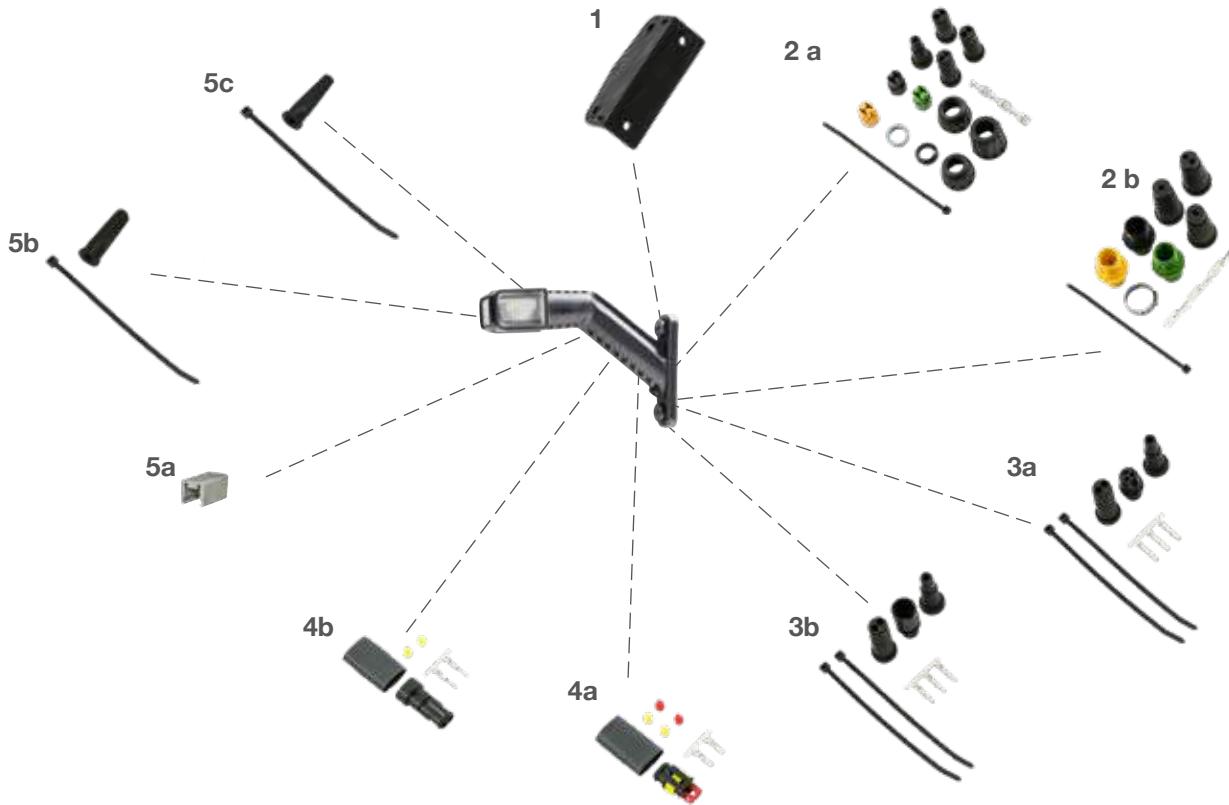

**1** Befestigungswinkel für Leuchtarm |  
angle bracket for end outline marker  
..... 15-5313-004

**2** ASS1 & ASS2 Verbinder |  
ASS1 & ASS2 connector  
(a) 2 pol. weiblich  
2 pin female ..... 13-5626-401   
(b) 2 pol. männlich  
2 pin male ..... 13-5625-991

**3** ASS3 Verbinder |  
ASS3 connector  
(a) 3 pol. weiblich  
3 pin female ..... 13-0322-281   
(b) 3 pol. männlich  
3 pin male ..... 13-0332-281

**4** Superseal Verbinder | Superseal connector  
(a) 2 pol. weiblich  
2 pin female ..... 15-7002-044   
(b) 2 pol. männlich  
2 pin male ..... 15-7002-054

**5** für P&R Verbinder |  
for P&R connector  
(a) Verschlusskappen  
caps ..... 15-5971-014   
(b) Endkappen rund  
end caps round ..... 15-5983-024   
(c) Endkappen eckig  
end caps square ..... 15-5729-014

# SUPERPOINT III LED

ADR Zone 2

IP69K

Umrissleuchte  
End Outline  
Marker

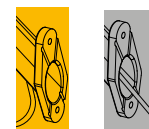
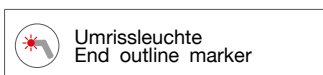
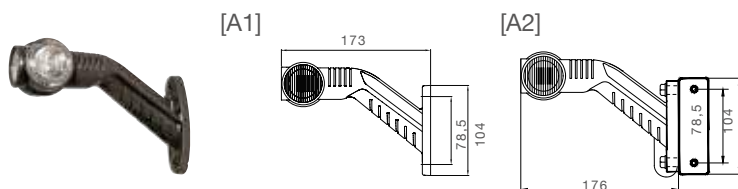

BEST. NR						ZUSATZ			ANSCHLUSS						
PART NO						ADD ON				CONNECTOR					
31-3365-094	1/20	●		LED	24V	[A2]				2 pol. ASS2 2 pin ASS2	♀			1,50 m	
31-3366-094	1/20		●	LED	24V	[A2]				2 pol. ASS2 2 pin ASS2	♀			1,50 m	
31-3300-074	1/15	●	●	LED	24V	[A1]				offenes Ende open end				4,00 m	
31-3302-054	1/20	●		LED	24V	[A1]				2 pol. Superseal 2 pin Superseal	♀			0,50 m	
31-3303-054	1/20		●	LED	24V	[A1]				2 pol. Superseal 2 pin Superseal	♀			0,50 m	
31-3304-044	1/25	●		LED	24V	[A1]				P&R				1,25 m	
31-3304-054	1/25		●	LED	24V	[A1]				P&R				1,25 m	
31-3304-114	1/-		●	LED	24V	[A1]				P&R				1,25 m	
31-3304-124	1/-	●		LED	24V	[A1]				P&R				1,25 m	
31-3304-134	1/25		●	LED	24V	[A1]				P&R				1,75 m	
31-3304-144	1/25	●		LED	24V	[A1]				P&R				1,75 m	
31-3305-014	1/30	●		LED	24V	[A1]				2 pol. ASS2 2 pin ASS2	♀			1,75 m	
31-3305-044	1/-	●		LED	24V	[A1]				2 pol. ASS2 2 pin ASS2	♀			2,00 m	
31-3305-124	1/-	●		LED	24V	[A1]				3 pol. ASS3 3 pin ASS3	♀			1,25 m	
31-3305-214	1/-	●		LED	24V	[A1]				2 pol. ASS2 2 pin ASS2	♀			0,50 m	
31-3305-294	1/50	●		LED	24V	[A1]				2 pol. Superseal 2 pin Superseal	♂			0,50 m	
31-3306-014	1/15		●	LED	24V	[A1]				2 pol. ASS2 2 pin ASS2	♀			1,50 m	



# SUPERPOINT III LED

ADR Zone 2 IP69K

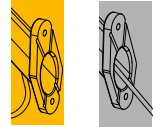
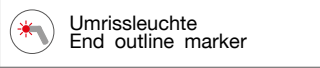
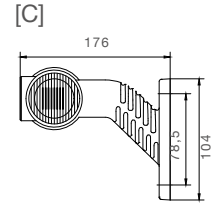
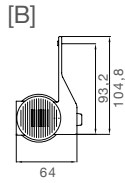

BEST. NR						ZUSATZ				ANSCHLUSS					
PART NO						ADD ON				CONNECTOR					
31-3306-044	1/-		●	LED	24V	[A1]				2 pol. ASS2 2 pin ASS2	♀			2,00 m	
31-3306-124	1/-		●	LED	24V	[A1]				3 pol. ASS3 3 pin ASS3	♀			1,25 m	
31-3306-214	1/-		●	LED	24V	[A1]				2 pol. ASS2 2 pin ASS2	♀			0,50 m	
31-3306-294	1/50		●	LED	24V	[A1]				2 pol. Superseal 2 pin Superseal	♂			0,50 m	
31-3362-004	1/-		●	LED	24V	[B]				2 pol. Superseal 2 pin Superseal	♀			0,25 m	
31-3362-104	1/50		●	LED	24V	[B]				2 pol. Superseal 2 pin Superseal	♂			1,50 m	
31-3363-004	1/-	●		LED	24V	[B]				2 pol. Superseal 2 pin Superseal	♀			0,25 m	
31-3363-104	1/50	●		LED	24V	[B]				2 pol. Superseal 2 pin Superseal	♂			1,50 m	
31-3364-024	1/50		●	LED	24V	[B]				P&R				1,50 m	
31-3364-054	1/40	●		LED	24V	[B]				P&R				1,50 m	
31-3365-014	1/-	●		LED	24V	[B]				offenes Ende open end				4,00 m	
31-3365-054	1/-	●		LED	24V	[B]				2 pol. ASS2 2 pin ASS2	♀			0,25 m	
31-3365-064	1/-	●		LED	24V	[B]				3 pol. ASS3 3 pin ASS3	♀			1,50 m	
31-3366-024	1/-		●	LED	24V	[B]				offenes Ende open end				4,00 m	
31-3366-054	1/-		●	LED	24V	[B]				2 pol. ASS2 2 pin ASS2	♀			0,25 m	
31-3366-064	1/-		●	LED	24V	[B]				3 pol. ASS3 3 pin ASS3	♀			1,50 m	
31-3305-084	1/50	●		LED	24V	[C]				Europoint II				0,04 m	
31-3306-084	1/-		●	LED	24V	[C]				offenes Ende open end				0,04 m	

# SUPERPOINT III LED

ADR Zone 2  IP69K





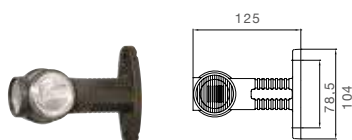



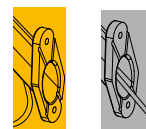
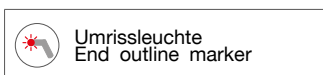
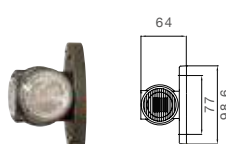































































































Umrissleuchte  
End Outline  
Marker

[D]



[E]



BEST. NR						ZUSATZ				ANSCHLUSS			
PART NO						ADD ON				CONNECTOR			
31-3300-244	1/30	●	●	LED	24V	[D]				offenes Ende open end	4,00 m		
31-3302-064	1/-		●	LED	24V	[D]				2 pol. Superseal 2 pin Superseal	♀   	0,50 m	
31-3303-064	1/-	●		LED	24V	[D]				2 pol. Superseal 2 pin Superseal	♀   	0,50 m	
31-3304-094	1/25	●	●	LED	24V	[D]				P&R	 	1,25 m	
31-3305-194	1/-	●		LED	24V	[D]				2 pol. ASS2 2 pin ASS2	♀   	2,00 m	
31-3306-194	1/-		●	LED	24V	[D]				2 pol. ASS2 2 pin ASS2	♀   	2,00 m	
31-3307-014	1/25	●	●	LED	24V	[D]				2 pol. ASS2 2 pin ASS2	♀   	1,75 m	
31-3307-024	1/-	●	●	LED	24V	[D]				3 pol. ASS3 3 pin ASS3	♀   	1,75 m	
31-3307-104	1/25	●	●	LED	24V	[D]				2 pol. ASS2 2 pin ASS2	♀   	2,50 m	
31-3307-194	1/40	●	●	LED	24V	[D]				2 pol. Superseal 2 pin Superseal	♂   	2,00 m	
31-3300-374	1/-	●	●	LED	24V	[E]				2 pol. Superseal 2 pin Superseal	♀   	3,00 m	
31-3307-044	1/-	●	●	LED	24V	[E]				2 pol. ASS2 2 pin ASS2	♀   	1,50 m	
31-3307-134	1/-	●	●	LED	24V	[E]				2 pol. ASS2 2 pin ASS2	♀   	3,00 m	
31-3307-224	1/50	●	●	LED	24V	[E]				3 pol. ASS3 3 pin ASS3	♀   	0,50 m	
31-3360-004	1/20	●	●	LED	24V	[E]				offenes Ende open end	4,00 m		
31-3364-004	1/25	●	●	LED	24V	[E]				P&R	 	1,50 m	
31-3367-004	1/50	●	●	LED	24V	[E]				2 pol. ASS2 2 pin ASS2	♀   	0,50 m	



# SUPERPOINT III LED

ZUBEHÖR / ACCESSORIES

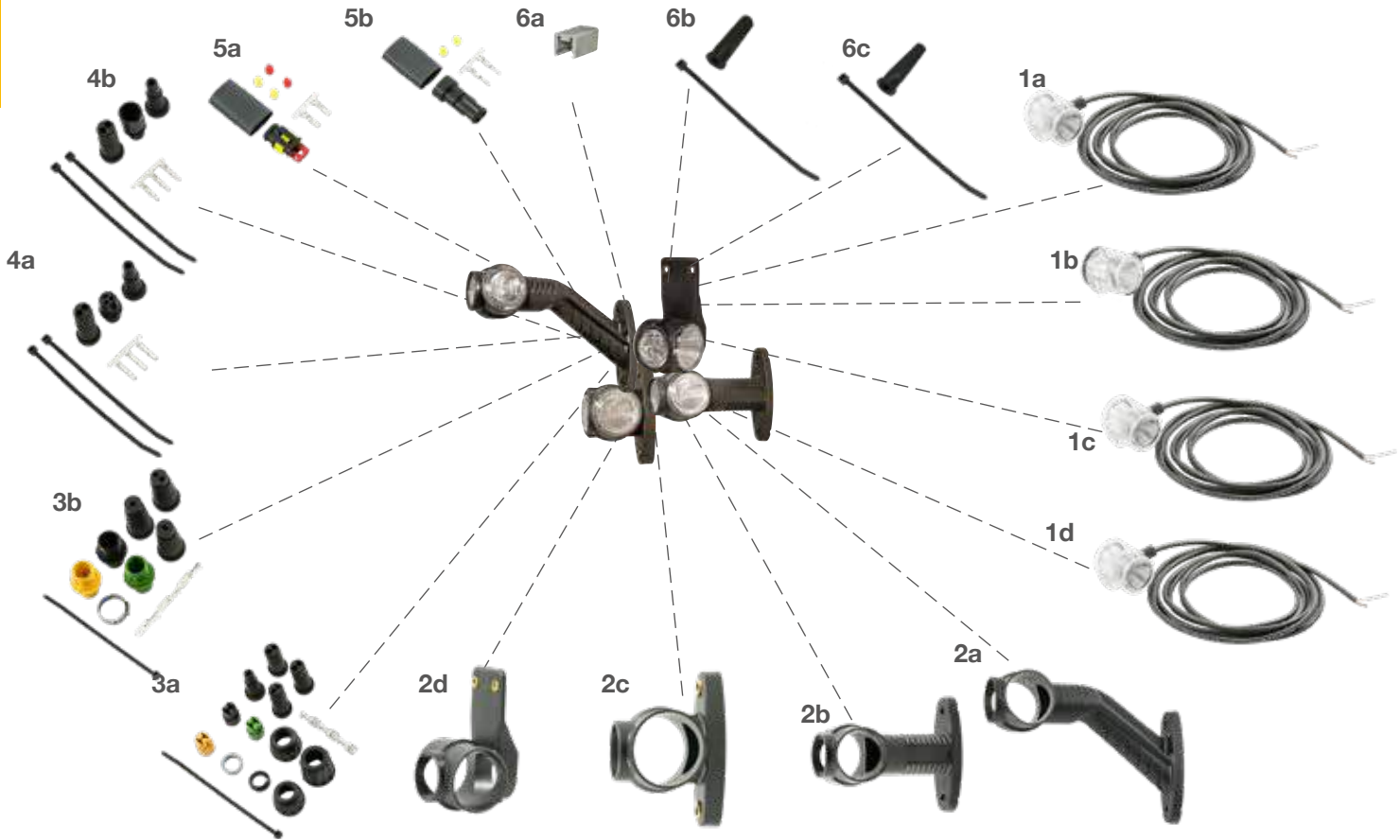

## 1 Lichtscheibe | lens

- (a) rot/weiß/orange mit 4,00 m Kabel  
red/white/orange with 4,00 m cable  
..... 21-3351-704
- (b) schwarz/weiß/orange mit 4,00 m Kabel  
black/white/orange with 4,00 m cable  
..... 21-3350-704
- (c) rot/weiß/orange mit 1,50 m Kabel  
red/white/orange with 1,50 m cable  
..... 21-3353-704
- (d) rot/weiß/orange mit 3,00 m Kabel  
red/white/orange with 3,00 m cable  
..... 21-3354-704

## 2 Umrissarm | end outline marker

- (a) Standard  
Standard..... 21-3300-007
- (b) gerade  
straight ..... 21-3302-007
- (c) Direktanbau  
direct mounting ..... 15-5325-004
- (d) mit Pendelhalter  
with pendular bracket.. 15-5325-101

## 3 ASS1 & ASS2 Verbinder | ASS1 & ASS2 connector

- (a) 2 pol. weiblich  
2 pin female ..... 13-5626-401
- (b) 2 pol. männlich  
2 pin male ..... 13-5625-991

## 4 ASS3 Verbinder | ASS3 connector

- (a) 3 pol. weiblich  
3 pin female ..... 13-0322-281
- (b) 3 pol. männlich  
3 pin male ..... 13-0332-281

## 5 Superseal Verbinder | Superseal connector

- (a) 2 pol. weiblich  
2 pin female ..... 15-7002-044
- (b) 2 pol. männlich  
2 pin male ..... 15-7002-054

## 6 für P&R Verbinder | for P&R connector

- (a) Verschlusskappen  
caps..... 15-5971-014
- (b) Endkappen rund  
end caps round..... 15-5983-024
- (c) Endkappen eckig  
end caps square..... 15-5729-014

# SUPERPOINT II

ADR  
Zone 2

IP 68

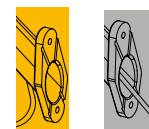
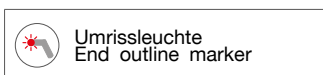
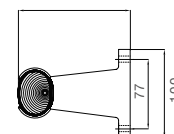
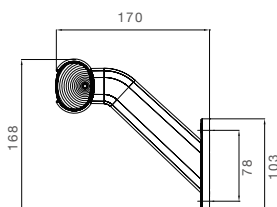

BEST. NR	PART NO	Box	←	→	Light	V	ZUSATZ	ADD ON	ANSCHLUSS	CONNECTOR	Length	Symbol
31-3404-014	1/20	●			●	24V	[A1]				1,25 m	
31-3404-104	1/25	●			●	24V	[A1]				1,80 m	
31-3404-124	1/-	●			●	24V	[A1]				1,25 m	
31-3404-364	-/-	●			●	24V	[A2]				1,80 m	
31-3405-004	1/-	●			●	24V	[A1]				1,75 m	
31-3405-074	-/-	●			●	24V	[A1]				1,25 m	
31-3407-114	1/-	●			●	24V	[A1]				0,50 m	
31-3404-004	1/20		●		●	24V	[A1]				1,25 m	
31-3404-064	1/-		●		●	24V	[A1]				1,80 m	
31-3404-114	-/-		●		●	24V	[A1]				1,80 m	
31-3404-134	1/25		●		●	24V	[A1]				1,30 m	
31-3406-004	1/35		●		●	24V	[A1]				1,75 m	
31-3406-064	1/25		●		●	24V	[A1]				1,25 m	
31-3407-104	1/-		●		●	24V	[A1]				0,50 m	
31-3704-004	1/45	●	●		●	24V	[B]				0,50 m	
31-3704-014	1/50	●	●		●	24V	[B]				1,50 m	
31-3707-024	1/25	●	●		●	24V	[B]				1,75 m	
31-3707-105	1/20	●			●	24V	[B]				2,00 m	



# SUPERPOINT II

[C]

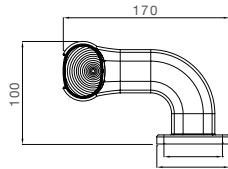

[D]

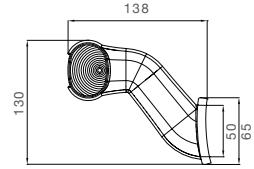

Umrissleuchte  
End outline marker

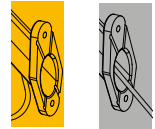



BEST. NR	PART NO	←	→	Light Bulb	⚡	ZUSATZ ADD ON	ANSCHLUSS CONNECTOR		Length	End		
31-3707-144	1/-	●		Light Bulb	24V	[B]	Red Pin, Red/Green Cable, Yellow Label	2 pol. ASS2 2 pin ASS2	♀	Green Connector, Green Label	0,50 m	┌
31-3793-004	1/20	●		Light Bulb	24V	[B]	Red Pin, Red/Green Cable, Yellow Label	2 pol. Superseal 2 pin Superseal	♀	Red/Green Connector, Red/Green Label	0,50 m	┌
31-3707-095	1/25		●	Light Bulb	24V	[B]	Red Pin, Red/Green Cable, Yellow Label	2 pol. ASS2 2 pin ASS2	♀	Green Connector, Green Label	2,00 m	┌
31-3707-134	1/-	●		Light Bulb	24V	[B]	Red Pin, Red/Green Cable, Yellow Label	2 pol. ASS2 2 pin ASS2	♀	Green Connector, Green Label	0,50 m	┌
31-3792-004	1/20		●	Light Bulb	24V	[B]	Red Pin, Red/Green Cable, Yellow Label	2 pol. Superseal 2 pin Superseal	♀	Red/Green Connector, Red/Green Label	0,50 m	┌
31-3804-014	1/-	●		Light Bulb	24V	[C]	Red Pin, Red/Green Cable, Yellow Label	P&R		Black Connector, Black Label	1,40 m	┌
31-3805-004	1/-	●		Light Bulb	24V	[C]	Red Pin, Red/Green Cable, Yellow Label	2 pol. ASS2 2 pin ASS2	♀	Green Connector, Green Label	1,75 m	┌
31-3805-024	-/-	●		Light Bulb	24V	[C]	Red Pin, Red/Green Cable, Yellow Label	2 pol. ASS3 2 pin ASS3	♀	Black Connector, Black Label	1,75 m	┌
31-3804-004	1/-	●		Light Bulb	24V	[C]	Red Pin, Red/Green Cable, Yellow Label	P&R		Black Connector, Black Label	1,40 m	┌
31-3806-004	1/-		●	Light Bulb	24V	[C]	Red Pin, Red/Green Cable, Yellow Label	2 pol. ASS2 2 pin ASS2	♀	Green Connector, Green Label	1,75 m	┌
31-3806-024	-/-		●	Light Bulb	24V	[C]	Red Pin, Red/Green Cable, Yellow Label	2 pol. ASS3 2 pin ASS3	♀	Black Connector, Black Label	1,75 m	┌
31-3604-044	1/25		●	Light Bulb	24V	[D]	Red Pin, Red/Green Cable, Yellow Label	P&R		Black Connector, Black Label	1,40 m	┌
31-3606-004	1/-		●	Light Bulb	24V	[D]	Red Pin, Red/Green Cable, Yellow Label	2 pol. ASS2 2 pin ASS2	♀	Green Connector, Green Label	1,75 m	┌
31-3608-004	1/25		●	Light Bulb	24V	[D]	Red Pin, Red/Green Cable, Yellow Label	offenes Ende open end			0,45 m	┌
31-3604-054	1/30	●		Light Bulb	24V	[D]	Red Pin, Red/Green Cable, Yellow Label	P&R		Black Connector, Black Label	1,40 m	┌
31-3605-004	1/-	●		Light Bulb	24V	[D]	Red Pin, Red/Green Cable, Yellow Label	2 pol. ASS2 2 pin ASS2	♀	Green Connector, Green Label	1,70 m	┌
31-3608-014	1/50	●		Light Bulb	24V	[D]	Red Pin, Red/Green Cable, Yellow Label	offenes Ende open end			0,45 m	┌

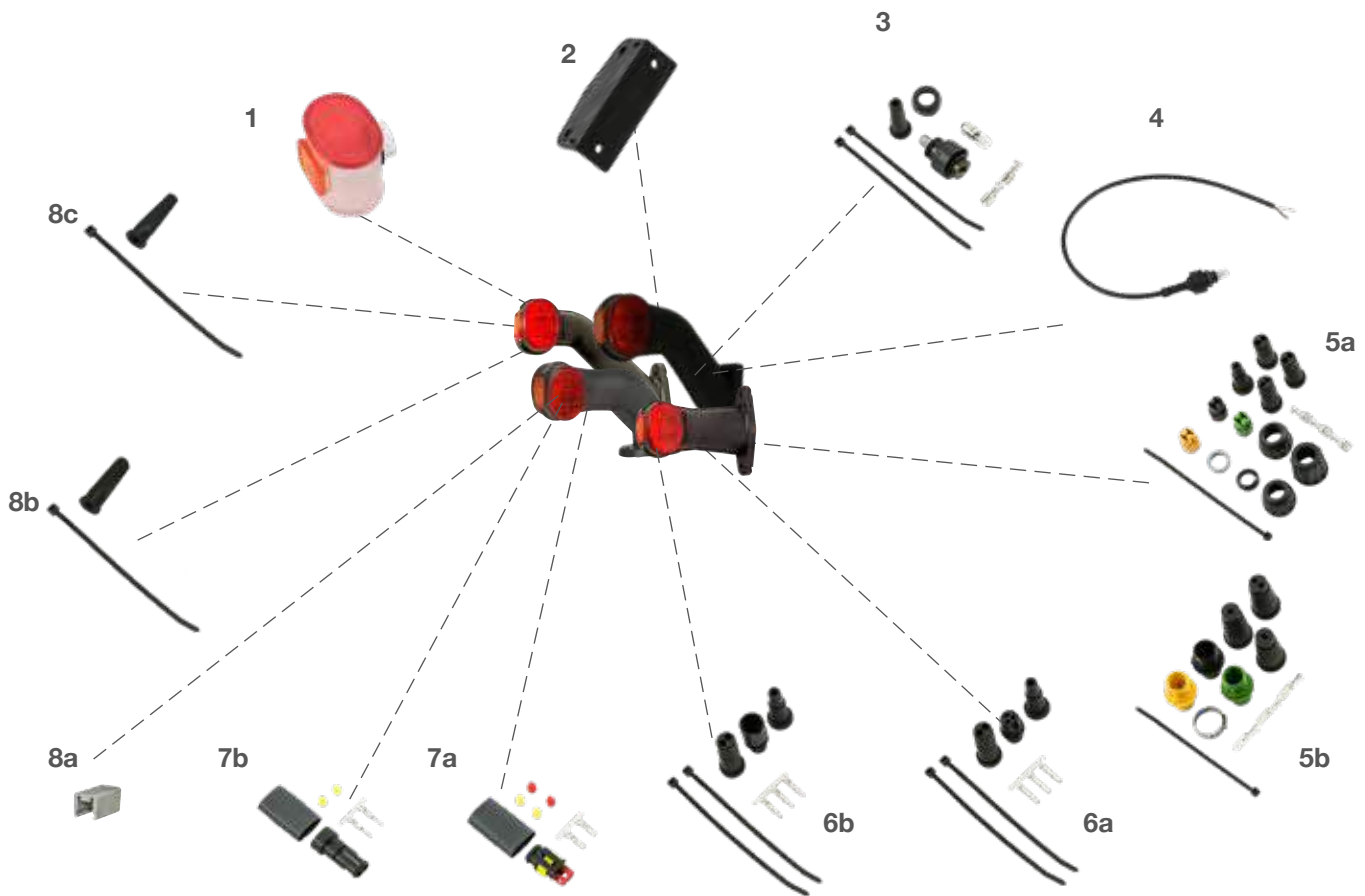

# SUPERPOINT II

ZUBEHÖR / ACCESSORIES



**1** Lichtscheibe | lens  
rot/weiß/orange  
red/white/orange  
..... 18-8136-004 

**2** Befestigungswinkel für Leuchtarm |  
angle bracket for end outline marker  
..... 15-5313-004 

**3** gerade Anschluss | straight connector  
..... 15-2128-544 

**4** Glühlampenanschluss | bulb connection  
inkl. Glühlampe und 0,5 m Kabel  
including bulb and 0,5 m cable  
..... 31-2800-004

**5** ASS1 & ASS2 Verbinder |  
ASS1 & ASS2 connector  
(a) 2 pol. weiblich  
2 pin female ..... 13-5626-401   
(b) 2 pol. männlich  
2 pin male ..... 13-5625-991 

**6** ASS3 Verbinder | ASS3 connector  
(a) 3 pol. weiblich  
3 pin female ..... 13-0322-281   
(b) 3 pol. männlich  
3 pin male ..... 13-0332-281 

**7** Superseal Verbinder | Superseal connector  
(a) 2 pol. weiblich  
2 pin female ..... 15-7002-044   
(b) 2 pol. männlich  
2 pin male ..... 15-7002-054 

**8** für P&R Verbinder |  
for P&R connector  
(a) Verschlusskappen  
caps ..... 15-5971-014   
(b) Endkappen rund  
end caps round ..... 15-5983-024   
(c) Endkappen eckig  
end caps square ..... 15-5729-014 



# FLEXIPOINT II LED

ADR  
Zone 2

IP 54



Produktinformation  
Product information

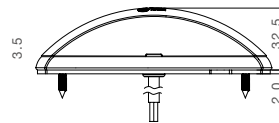
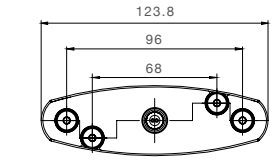
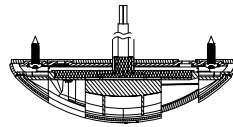
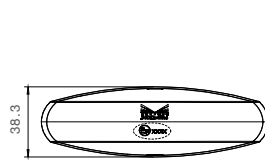

Umrissleuchte  
End outline marker

BEST. NR		←	→			ZUSATZ	ANSCHLUSS	
PART NO						ADD ON	CONNECTOR	
31-8524-004	1/20	●	●	LED	12V 24V	klare Lichtscheibe	offenes Ende open end	1,50 m
31-8524-014	1/20	●	●	LED	12V 24V	klare Lichtscheibe	DC Flachkabel DC flat cable	2,50 m
31-8524-024	1/20	●		LED	12V 24V	klare Lichtscheibe	DC Flachkabel DC flat cable	2,50 m
31-8524-044	1/20		●	LED	12V 24V	klare Lichtscheibe	DC Flachkabel DC flat cable	5,00 m



# FLEXIPOINT II LED

ZUBEHÖR / ACCESSORIES

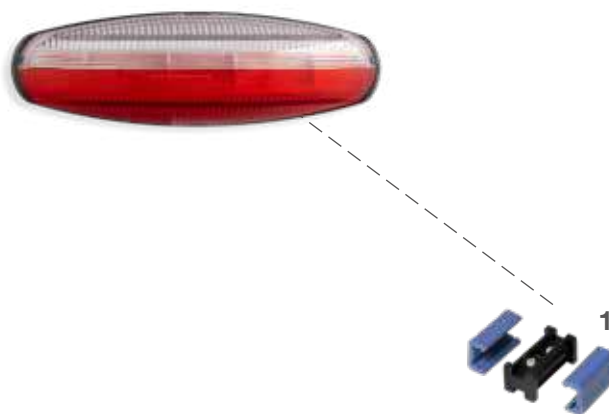

- 1** DC-Verbinder (10 Sackerl) |  
DC connector (10 bags)  
..... 15-5976-034 



# FLEXIPOINT I LED

ADR  
Zone 2

IP 54



[A]

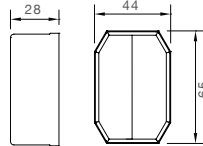

[B]

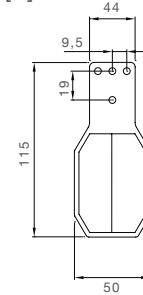

Umrissleuchte  
End outline marker

BEST. NR PART NO		←	→			ZUSATZ ADD ON		ANSCHLUSS CONNECTOR		
						[A]	[B]			
31-6300-004	1/-	●	●	LED	12V 24V	[A]			offenes Ende open end	1,00 m
31-6304-014	1/-	●	●	LED	12V 24V	[A]			P&R	1,00 m
31-6364-004	1/-	●		LED	12V 24V	[B]			P&R	1,00 m
31-6364-014	1/-		●	LED	12V 24V	[B]			P&R	1,00 m



# FLEXIPOINT I LED

ZUBEHÖR / ACCESSORIES

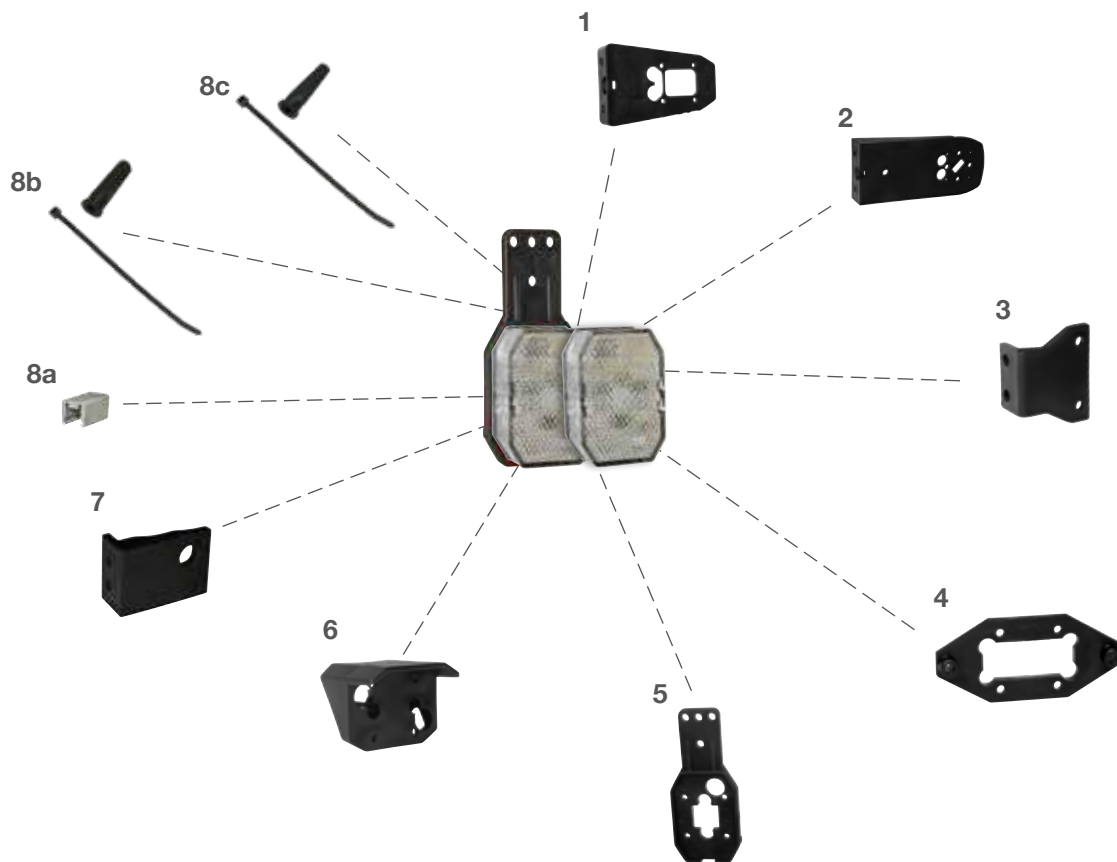

**1** Aufhängelasche 100 mm |  
bracket 100 mm  
..... 15-5310-104

**2** Aufhängelasche 150 mm |  
bracket 150 mm  
..... 15-5311-004

**3** 90° Winkelhalter | 90° bracket  
..... 15-5318-004

**4** wendbare Halteplatte | turnable flat bracket  
..... 15-5316-004

**5** flexibler gerader Gummihalter |  
flexible straight rubber bracket  
..... 15-5312-104

**6** Kotflügelhalter | mud guard bracket  
..... 15-5314-104

**7** Winkelhalter soft | soft bracket  
..... 15-5316-704

**8** für P&R Verbinder | for P&R connector  
(a) Verschlusskappen  
caps..... 15-5971-014   
(b) Endkappen rund  
end caps round..... 15-5983-024   
(c) Endkappen eckig  
end caps square..... 15-5729-014



# FLEXIPOINT I



[A]

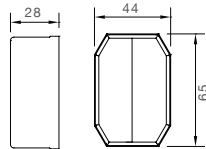

[B]

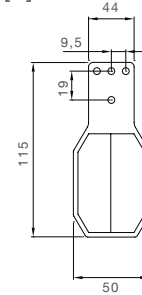

Umrissleuchte  
End outline marker

BEST. NR PART NO		←	→			ZUSATZ ADD ON			ANSCHLUSS CONNECTOR				
						[A]	[B]				Length		
31-6504-084	1/-	●	●		24V	[A]			P&R			0,50 m	
31-6504-134	-/-	●	●		24V	[A]			P&R			2,00 m	
31-6504-104	-/-	●	●		24V	[A]			P&R			0,25 m	
31-6504-174	1/-	●	●		24V	[A]			P&R			0,50 m	
31-6564-064	1/-		●		24V	[B]			P&R			0,50 m	
31-6564-074	1/50	●			24V	[B]			P&R			0,50 m	
31-6564-144	1/-		●		24V	[B]			P&R			1,50 m	
31-6564-154	1/25	●			24V	[B]			P&R			1,50 m	



# FLEXIPOINT I

ZUBEHÖR / ACCESSORIES

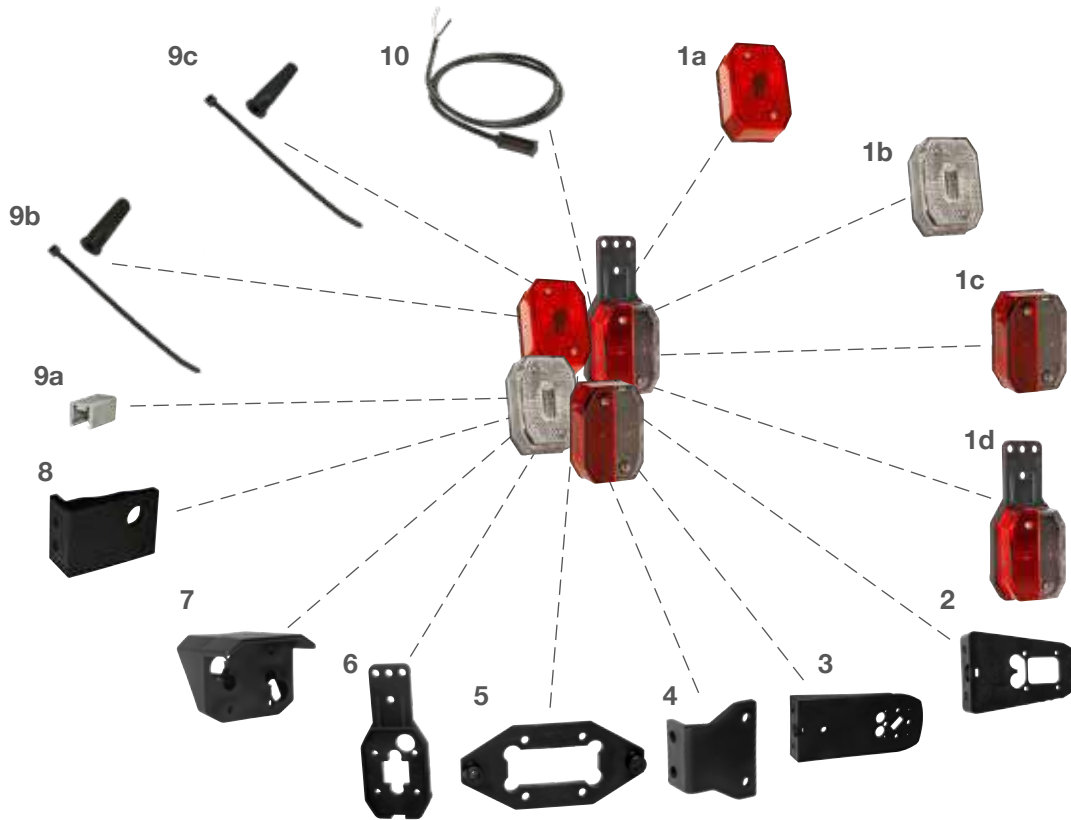

- 1 Ersatzteileuchte | spare part lamp**
- (a) rot ..... 21-6510-004
  - (b) weiß ..... 21-6512-004
  - (c) rot/weiß ..... 21-6513-004
  - (d) rot/weiß mit Aufhängelasche ..... 21-6513-214

- 2 Aufhängelasche 100 mm | bracket 100 mm**
- ..... 15-5310-104

- 3 Aufhängelasche 150 mm | bracket 150 mm**
- ..... 15-5311-004

- 4 90° Winkelhalter | 90° bracket**
- ..... 15-5318-004

- 5 wendbare Halteplatte | turnable flat bracket**
- ..... 15-5316-004

- 6 flexibler gerader Gummihalter | flexible straight rubber bracket**
- ..... 15-5312-104

- 7 Kotflügelhalter | mud guard bracket**
- ..... 15-5314-104

- 8 Winkelhalter soft | soft bracket**
- ..... 15-5316-704

- 9 für P&R Verbinder | for P&R connector**
- (a) Verschlusskappen caps..... 15-5971-014
  - (b) Endkappen rund end caps round..... 15-5983-024
  - (c) Endkappen eckig end caps square..... 15-5729-014

- 10 Zuleitung P&R | front connection P&R**
- 0,5 m..... 68-5000-574
  - 1,5 m..... 68-5000-604
  - 5,0 m..... 68-5000-634

SPÖCK®

S T E M S



ERSATZTEILE | SPARE PARTS



## POSITIONSLEUCHE

Unsere Positionslampen erfüllen, je nach Farbwahl der Lichtscheibe, unterschiedliche Funktionen. Ihr Design ist einheitlich und geradlinig. Ihre Montage kann direkt oder mit Halter erfolgen. Universelle Anschlüsse machen die Positionslampen zu universellen Lichtlösungen.

## POSITION LAMP

Our position lamps fulfill different functions, depending on the color selection of the lens. Their design is uniform and clean. They can be mounted directly or with a bracket. Universal connections make the position lamps universal lighting solutions.

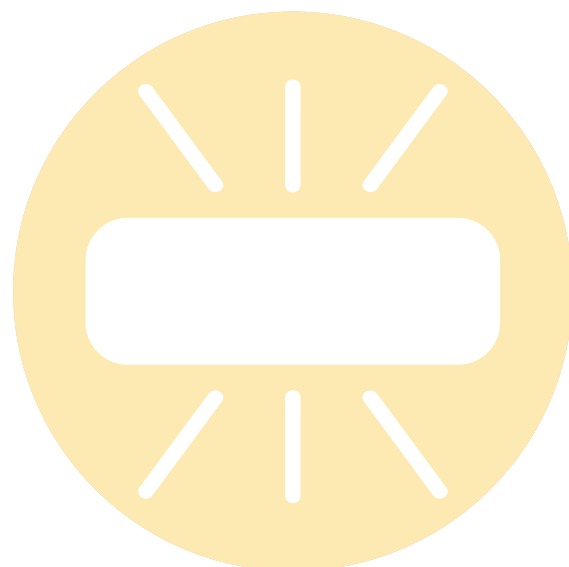



# FLATPOINT II LED

ADR Zone 2 IP69K

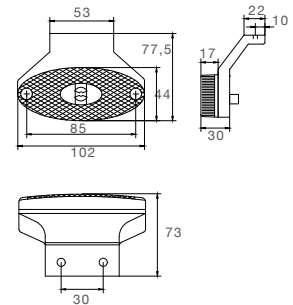
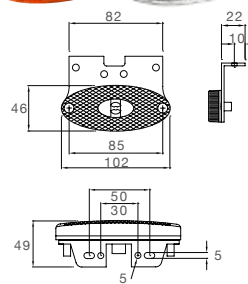
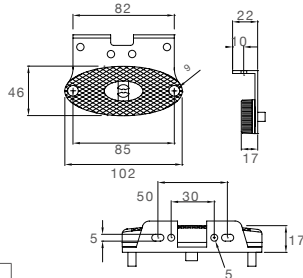
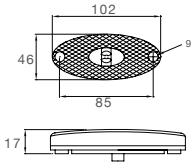

BEST. NR PART NO				ZUSATZ ADD ON		ANSCHLUSS CONNECTOR				
31-2304-014	1/-	LED	24V	[A]	Bild	P&R			0,50 m	
31-2304-034	1/50	LED	24V	[A]	Bild	P&R			1,50 m	
31-2304-044	1/50	LED	24V	[A]	Bild	P&R			2,00 m	
31-2304-094	1/50	LED	12V 24V	[A]	Bild	P&R			1,50 m	
31-2304-104	-/-	LED	12V 24V	[A]	Bild	P&R			0,50 m	
31-2307-004	1/30	LED	24V	[A]	Bild	2 pol. ASS3 2 pin ASS3	♀		0,50 m	
31-2307-014	1/50	LED	24V	[A]	Bild	2 pol. ASS3 2 pin ASS3	♀		1,50 m	
31-2364-014	1/100	LED	24V	[B]	Bild	P&R			0,50 m	
31-2364-034	1/50	LED	24V	[B]	Bild	P&R			1,50 m	
31-2364-084	1/50	LED	24V	[C]	Bild	P&R			0,50 m	
31-2364-104	1/50	LED	24V	[C]	Bild	P&R			1,50 m	
31-2364-114	1/25	LED	24V	[C]	Bild	P&R			2,00 m	
31-2364-184	1/50	LED	24V	[D]	Bild	P&R			1,50 m	
31-2364-304	1/-	LED	24V	[E]	Bild	P&R			0,25 m	



# FLATPOINT II LED

ADR Zone 2 IP69K

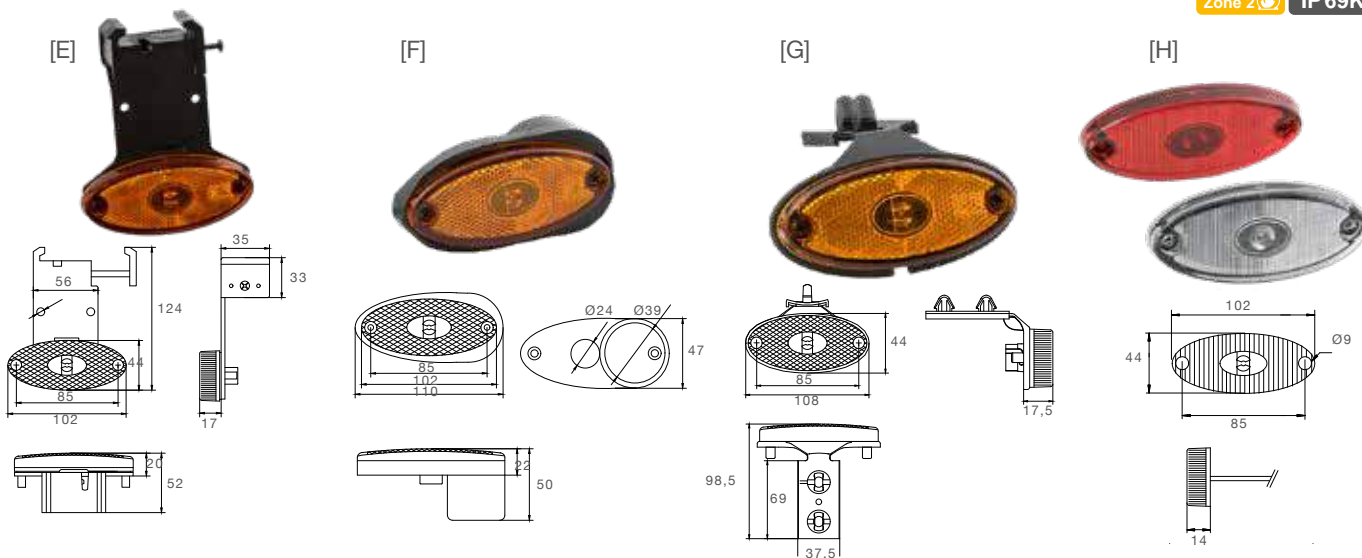

Positionslampe  
Position Lamp

BEST. NR				ZUSATZ	ANSCHLUSS	
PART NO				ADD ON	CONNECTOR	
31-2364-324	1/-	LED	24V	[F] Bild	P&R	2,00 m
31-2364-334	1/-	LED	24V	[G] Bild	P&R	1,50 m
31-2364-344	1/-	LED	24V	[G] Bild	P&R	1,00 m
31-2364-354	1/50	LED	24V	[G] Bild	P&R	2,00 m
31-2367-034	1/-	LED	24V	[C] Bild	2 pol. ASS3 2 pin ASS3	1,50 m
31-2367-054	-/-	LED	24V	[B] Bild	2 pol. ASS3 2 pin ASS3	1,50 m
31-2367-064	1/50	LED	24V	[G] Bild	2 pol. ASS3 2 pin ASS3	1,50 m
31-6900-014	1/20	LED	24V	[A] Bild	offenes Ende open end	0,50 m
31-6904-014	1/100	LED	24V	[A] Bild	P&R	0,50 m
31-6904-034	1/50	LED	24V	[A] Bild	P&R	1,50 m
31-6904-054	1/50	LED	24V	[A] Bild	P&R	3,50 m
31-6904-124	1/-	LED	24V	[H] Bild	P&R	3,50 m
31-6904-164	-/-	LED	12V 24V	[A] Bild	P&R	1,50 m
31-6907-034	-/-	LED	24V	[A] Bild	2 pol. ASS3 2 pin ASS3	1,50 m
31-6964-004	-/-	LED	24V	[C] Bild	P&R	1,50 m
31-6404-014	1/50	LED	24V	[A] Bild	P&R	0,50 m
31-6404-094	1/-	LED	24V	[H] Bild	P&R	0,50 m
31-6404-124	1/50	LED	24V	[H] Bild	P&R	3,50 m



# FLATPOINT II LED

ZUBEHÖR / ACCESSORIES

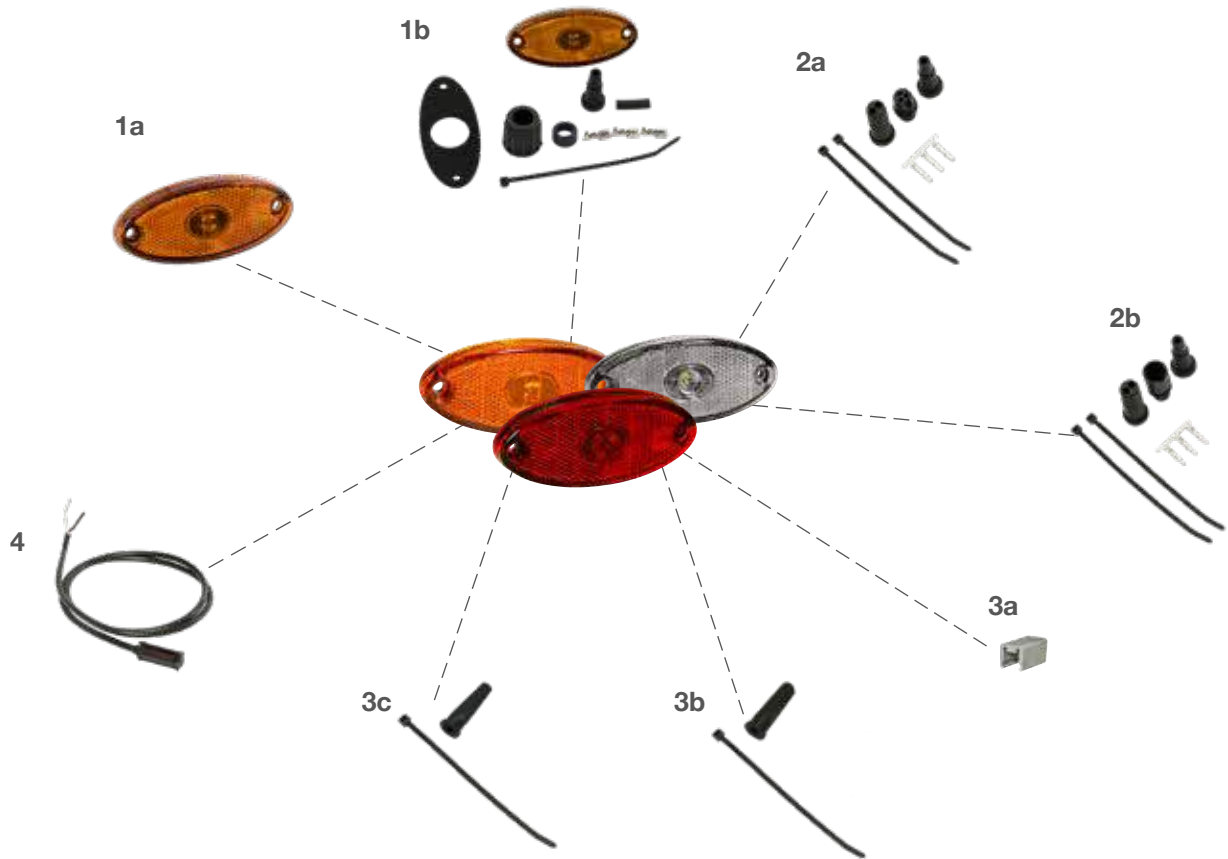

## 1 Ersatzleuchte orange | spare part lamp orange

- (a) lose  
loose..... 21-2303-004
- (b) mit Bajonett- Mutter  
with bayonet-nut ..... 21-2302-004

## 2 ASS3 Verbinder | ASS3 connector

- (a) 3 pol. weiblich  
3 pin female ..... 13-0322-281
- (b) 3 pol. männlich  
3 pin male ..... 13-0332-281

## 3 für P&R Verbinder | for P&R connector

- (a) Verschlusskappen  
caps..... 15-5971-014
- (b) Endkappen rund  
end caps round..... 15-5983-024
- (c) Endkappen eckig  
end caps square..... 15-5729-014

## 4 Anschlusskabel P&R | connection cable P&R

- 0,5 m..... 68-5000-014
- 1,5 m..... 68-5000-034







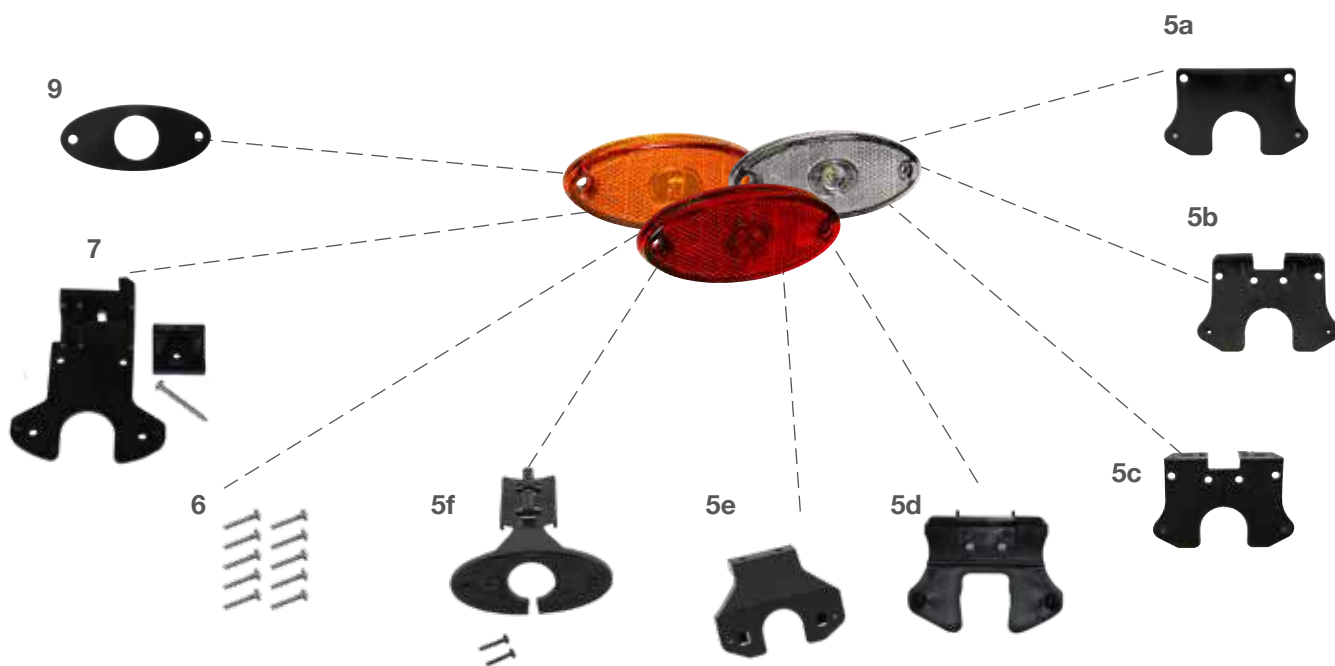

# FLATPOINT II LED

ZUBEHÖR / ACCESSORIES



## 5 Haltewinkel | bracket

- (a) gerade  
straight ..... 15-5321-004
- (b) 90° nach vorne  
90° to the front..... 15-5321-104 
- (c) 90° nach hinten  
90° to the back..... 15-5321-204 
- (d) 90° durchgehend nach hinten  
90° continuous to the back  
..... 15-5321-404
- (e) schräg 90° nach hinten  
sloping 90° to the back  
..... 15-2128-214 
- (f) Schnellhalter + Schrauben  
quick-fixation bracket + screws  
..... 15-5321-234 

## 6 Schrauben für Haltewinkel 10 screws for bracket

- ..... 14-0418-304 

## 7 Verriegelungswinkel | locking bracket

- Verriegelungswinkel  
locking angle  
..... 15-5322-004 

## 9 Gummiunterlage | rubber base

- ..... 15-5111-004 





# FLATPOINT I LED

ADR Zone 2

IP 68

[A]

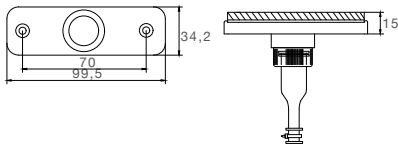

[B]

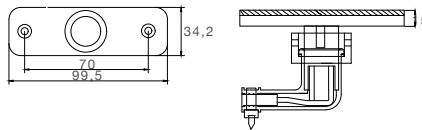

[C]

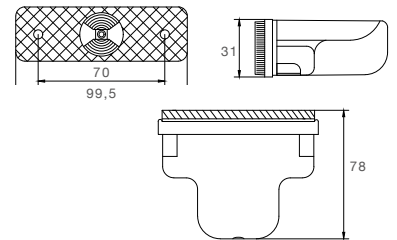

BEST. NR				ZUSATZ					ANSCHLUSS			
PART NO				ADD ON					CONNECTOR			
31-6604-014	1/50	LED	24V	[A] Bild				P&R			0,50 m	
31-6604-034	1/-	LED	24V	[A]				P&R			1,50 m	
31-6604-074	1/50	LED	24V	[B] Bild				P&R			0,50 m	
31-6604-094	1/-	LED	24V	[B]				P&R			1,50 m	
31-6604-114	-/-	LED	24V	[B]				P&R			3,50 m	
31-6607-004	1/50	LED	24V	[B] Bild				2 pol. ASS2 2 pin ASS2			1,50 m	
31-6607-054	1/75	LED	24V	[A] Bild				2 pol. ASS3 2 pin ASS3			1,50 m	
31-6614-014	1/50	LED	24V	[C] Bild				Schutzhaube protection cap			0,50 m	
31-6614-034	1/50	LED	24V	[C]				Schutzhaube protection cap			1,50 m	
31-6614-074	1/50	LED	24V	[D] Bild				Schutzhaube protection cap			0,50 m	
31-6614-094	1/40	LED	24V	[D]				Schutzhaube protection cap			1,50 m	
31-6664-014	1/-	LED	24V	[E] Bild				Schutzhaube protection cap			0,50 m	
31-6664-031	1/30	LED	24V	[E]				Schutzhaube protection cap			1,50 m	
31-6667-014	-/-	LED	24V	[D] Bild				Schutzhaube protection cap	2 pol. ASS3 2 pin ASS3		0,50 m	



# FLATPOINT I LED

ADR  
Zone 2

IP 68

[D]

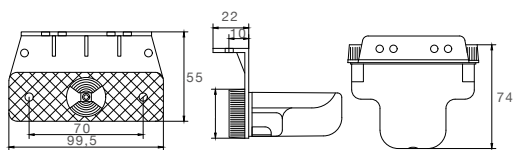

[E]

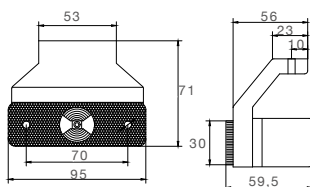

[F]

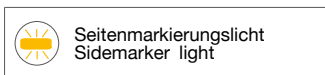
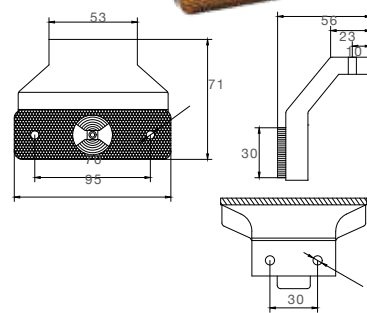

Positionslampe  
Position Lamp

BEST. NR PART NO				ZUSATZ ADD ON	ANSCHLUSS CONNECTOR
31-2204-014	1/50	LED	24V	[A] Bild	P&R  0,50 m
31-2214-004	1/50	LED	24V	[D] Bild    Schutzhaube protection cap	P&R  0,25 m
31-2214-014	1/-	LED	24V	[D]    Schutzhaube protection cap	P&R  0,50 m
31-2214-024	1/50	LED	24V	[D]    Schutzhaube protection cap	P&R  1,00 m
31-2214-034	1/50	LED	24V	[D]    Schutzhaube protection cap	P&R  1,50 m
31-2214-114	1/50	LED	24V	[C]    Schutzhaube protection cap	P&R  0,50 m
31-2214-134	1/25	LED	24V	[C]    Schutzhaube protection cap	P&R  1,50 m
31-2264-014	1/-	LED	24V	[F] Bild	P&R  0,50 m
31-2264-024	1/50	LED	24V	[F]	P&R  1,00 m
31-2264-034	1/-	LED	24V	[F]	P&R  1,50 m
31-2267-014	1/-	LED	24V	[E] Bild    Schutzhaube protection cap	2 pol. ASS2 ♀  1,00 m
31-2267-064	1/70	LED	24V	[C] Bild    Schutzhaube protection cap	3 pol. ASS3 ♀  1,50 m
31-2267-074	1/50	LED	24V	[D] Bild    Schutzhaube protection cap	3 pol. ASS3 ♀  1,50 m
31-2267-084	1/50	LED	24V	[E] Bild    Schutzhaube protection cap	3 pol. ASS3 ♀  1,50 m



## FLATPOINT I LED

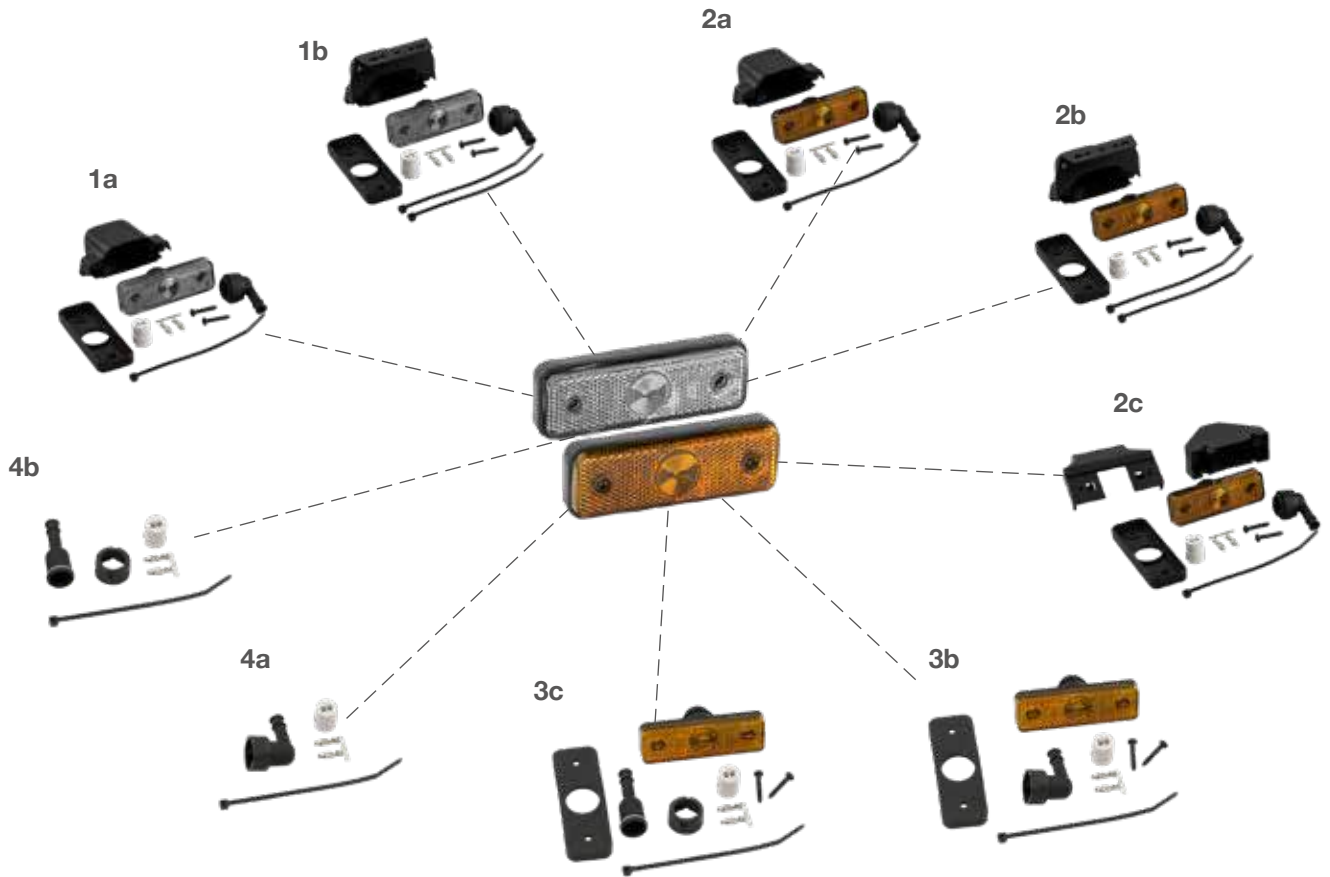

### 1 Ersatzleuchte weiß mit Schutzhaube | spare part lamp white with protection cap

(a) mit 90° Anschluss ohne Haltewinkel  
with 90° connector without bracket

..... 21-6601-004

(b) mit 90° Anschluss und 90° Haltewinkel  
with 90° connector and 90° bracket

..... 21-6600-004

### 2 Ersatzleuchte orange mit Schutzhaube | spare part lamp orange with protection cap

(a) mit 90° Anschluss ohne Haltewinkel  
with 90° connector without bracket

..... 21-2201-004

(b) mit 90° Anschluss und 90° Haltewinkel  
with 90° connector and 90° bracket

..... 21-2200-014

(c) mit 90° Anschluss und 90° Haltewinkel schräg  
with 90° connector and sloping 90° bracket

..... 21-2202-004

### 3 Ersatzleuchte orange ohne Schutzhaube | spare part lamp orange without protection cap

(a) mit 90° Anschluss  
with 90° connector

..... 21-2201-014

(b) mit geradem Anschluss  
with straight connector

..... 21-2201-044

### 4 Anschluss | connector

(a) 90° gewinkelt  
angled connection 90°

..... 15-2122-104

(b) gerade komplett  
straight bracket complete

..... 15-2122-124

### 5 ASS1 & ASS2 Verbinder | ASS1 & ASS2 connector

(a) 2 pol. männlich

2 pin male ..... 13-5625-991

(b) 2 pol. weiblich

2 pin female ..... 13-5626-401

### 6 ASS3 Verbinder | ASS3 connector

(a) 3 pol. weiblich

3 pin female ..... 13-0322-281

(b) 3 pol. männlich







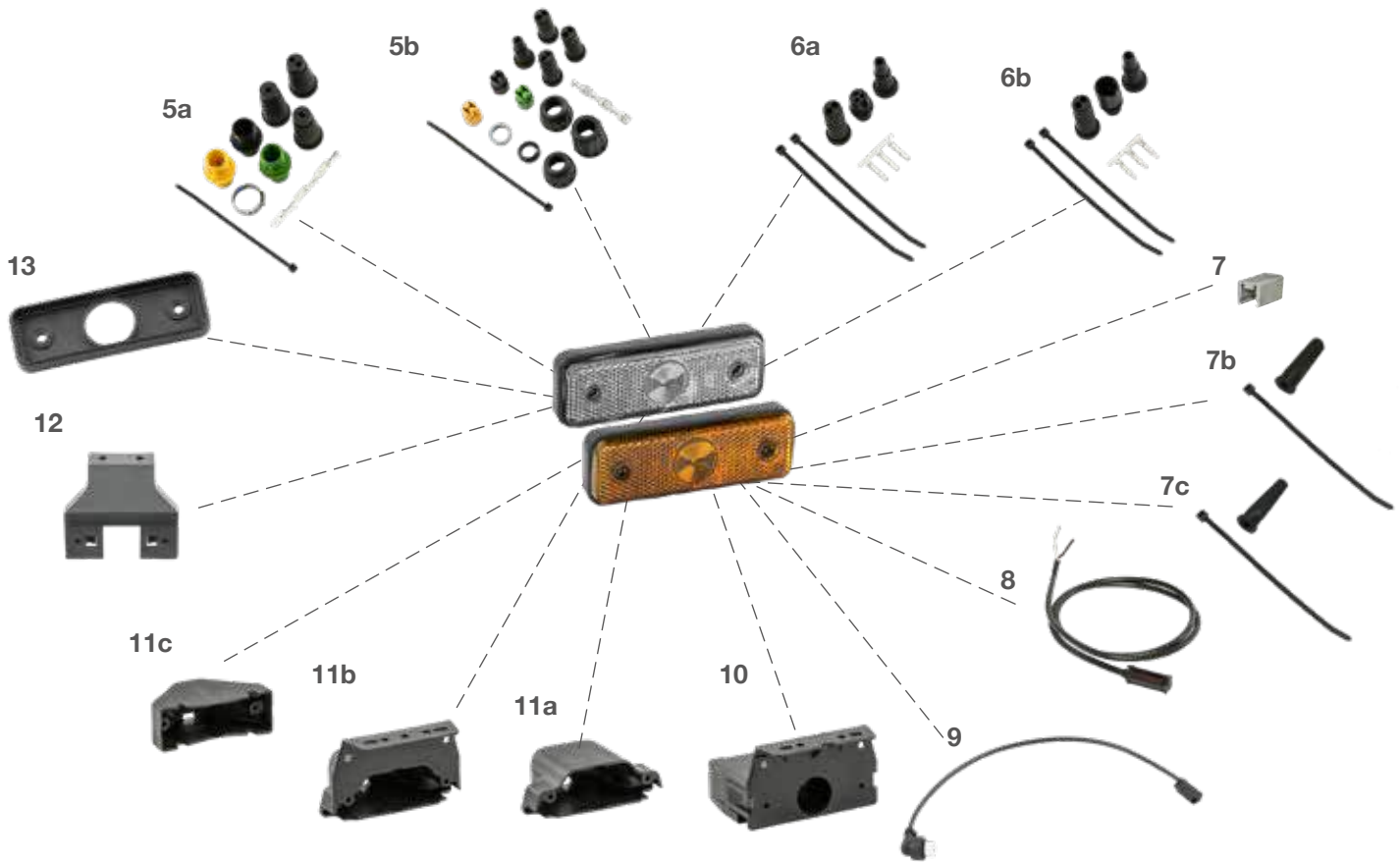

# FLATPOINT | LED

ZUBEHÖR / ACCESSORIES



3 pin male ..... 13-0332-281 

## 7 für P&R Verbinder | for P&R connector

- (a) Verschlusskappen  
caps ..... 15-5971-014 
- (b) Endkappen rund  
end caps round ..... 15-5983-024 
- (c) Endkappen eckig  
end caps square ..... 15-5729-014 

## 8 Anschlusskabel P&R | connection cable P&R

0,50 m ..... 68-5000-014 

1,50 m ..... 68-5000-034 



## 9 Zuleitung P&R | front connection P&R

0,50 m ..... 31-2204-154

## 10 Sockel mit Haltewinkel und Schutzhaube | socket with bracket and protection cap

..... 15-2128-274 

## 11 Schutzhaube | protection cap

- (a) ohne Haltewinkel  
without bracket ..... 15-2122-164 
- (b) mit 90° Haltewinkel  
with 90° bracket ..... 15-2122-174 
- (c) für schrägen Haltewinkel  
for sloping bracket ..... 15-2128-094 

## 12 Haltewinkel | bracket

schräg  
sloping ..... 15-2128-144 

## 13 Gummiauflage | rubber base

..... 11-2128-194 





# UNIPOINT II LED

ADR Zone 2 IP6K9K



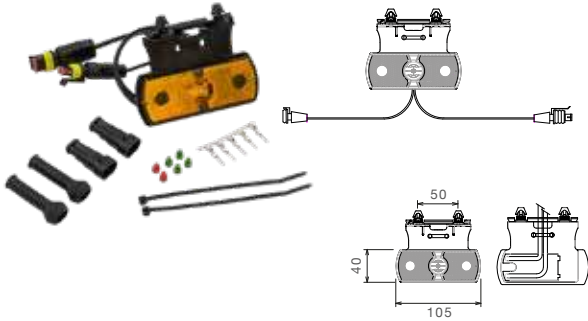



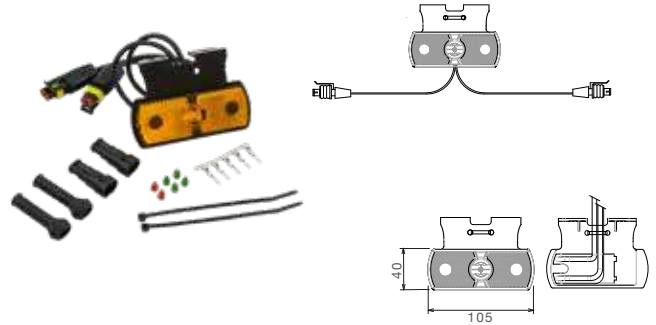





[A]



[B]



 Seitenmarkierungslicht  
Sidemarker light

BEST. NR				ZUSATZ	ANSCHLUSS
PART NO		LED	24V	ADD ON	CONNECTOR
31-2464-024	1/60	LED	24V	[A]  	2 x 2 pol. Superseal 2 x 2 pin Superseal ♀   0,40 m 
31-2464-034	1/60	LED	24V	[B]  	2 x 2 pol. Superseal 2 x 2 pin Superseal ♀   0,40 m 









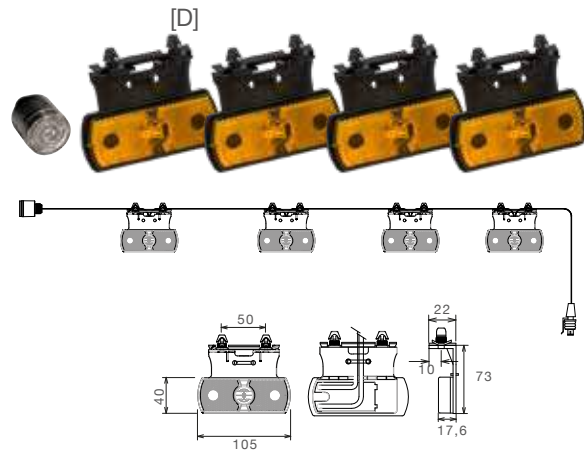
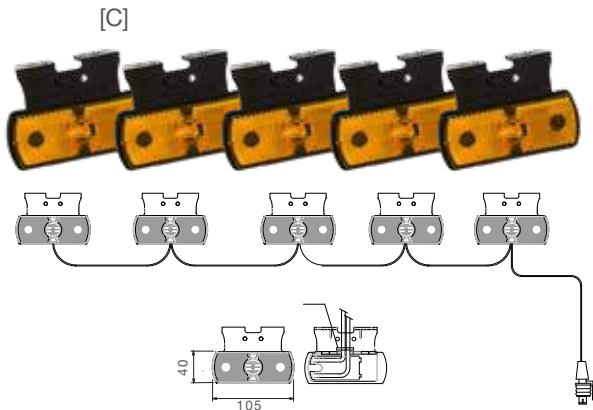









# UNIPOINT II LED

ZUBEHÖR / ACCESSORIES

ADR Zone 2 IP 6K9K





 Seitenmarkierungslicht  
Sidemarker light

BEST. NR PART NO				ZUSATZ ADD ON	ANSCHLUSS CONNECTOR
87-1368-011	1/-	LED	24V	[C]   	2 pol. Superseal 2 pin Superseal   2,20 m 
87-1366-011	1/8	LED	24V	[D]   	2 pol. Superseal 2 pin Superseal   6,04 m 

ZUBEHÖR / ACCESSORIES

## 1 Superseal Verbinder | Superseal connector

- (a) 2 pol. weiblich  
2 pin female ..... 15-7002-044 
- (b) 2 pol. männlich  
2 pin male ..... 15-7002-054 





# UNIPOINT I LED

ADR Zone 2 IP 6K9K

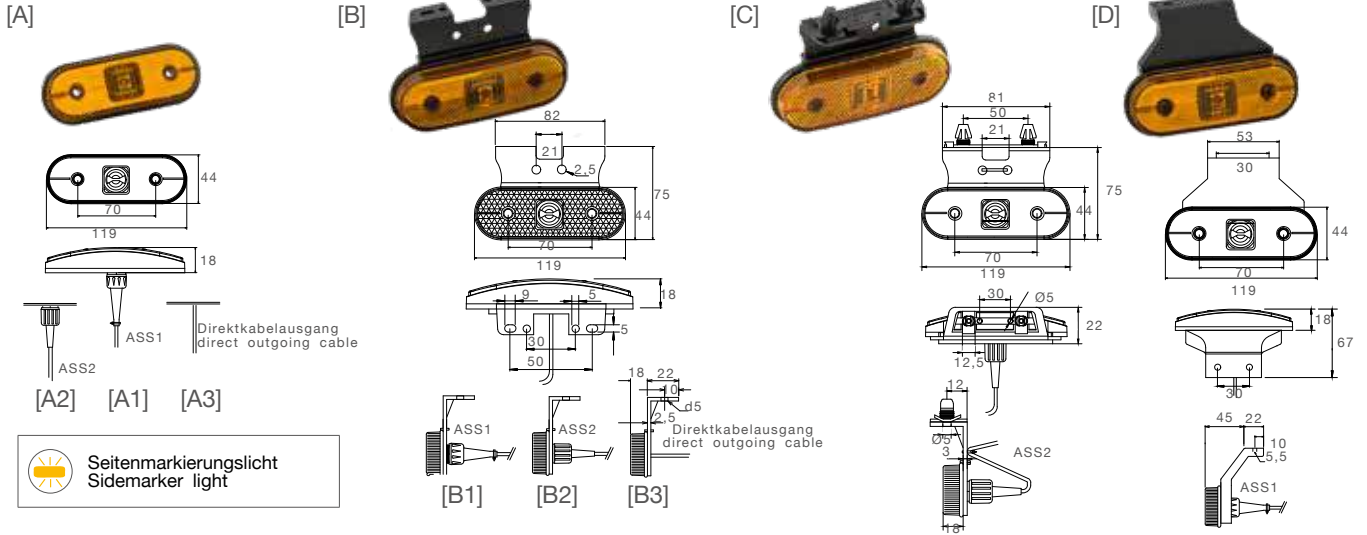

BEST. NR PART NO				ZUSATZ ADD ON	ANSCHLUSS CONNECTOR	
31-2000-014	-/-	LED	24V	[A3]	offenes Ende open end	0,50 m
31-2000-034	-/-	LED	24V	[A3]	offenes Ende open end	1,50 m
31-2004-014	1/100	LED	24V	[A1]	P&R	0,50 m
31-2004-034	1/50	LED	24V	[A1]	P&R	1,50 m
31-2004-044	1/-	LED	24V	[A1]	P&R	2,00 m
31-2004-074	1/50	LED	24V	[A1]	P&R	2,50 m
31-2007-024	-/-	LED	24V	[A2]	2 pol. ASS2 2 pin ASS2	1,00 m
31-2007-234	1/-	LED	24V	[A2]	3 pol. ASS3 3 pin ASS3	0,50 m
31-2007-244	1/25	LED	24V	[A2]	3 pol. ASS3 3 pin ASS3	1,50 m
31-2007-294	1/-	LED	24V	[A2]	2 pol. ASS2 2 pin ASS2	2,00 m
31-2007-304	1/-	LED	24V	[A3]	3 pol. ASS3 3 pin ASS3	0,50 m
31-2007-334	1/-	LED	24V	[A3]	3 pol. ASS3 3 pin ASS3	1,50 m
31-2007-344	1/100	LED	24V	[A3]	2 pol. ASS2 2 pin ASS2	0,50 m
31-2064-014	1/90	LED	24V	[B1]	P&R	0,50 m
31-2064-034	1/75	LED	24V	[B1]	P&R	1,50 m
31-2064-124	1/-	LED	24V	[C]	P&R	2,00 m
31-2064-214	1/50	LED	24V	[D]	P&R	0,50 m



# UNIPOINT I LED

ADR Zone 2 IP 6K9K

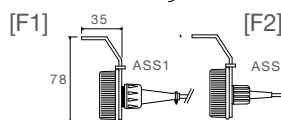
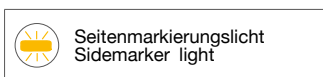
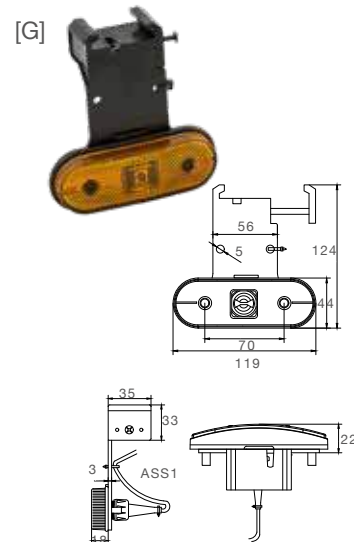
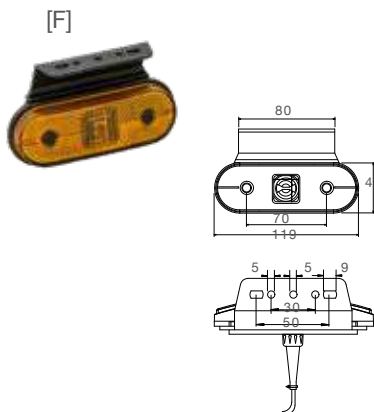
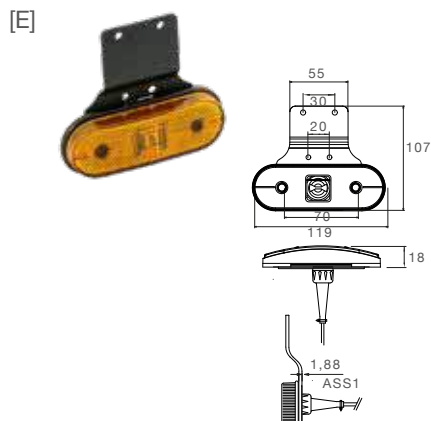

BEST. NR PART NO				ZUSATZ ADD ON	ANSCHLUSS CONNECTOR	
31-2064-234	1/35	LED	24V	[D]	P&R	1,50 m
31-2064-414	1/50	LED	24V	[E]	P&R	0,50 m
31-2064-434	1/-	LED	24V	[E]	P&R	1,50 m
31-2064-714	1/45	LED	24V	[F1]	P&R	0,50 m
31-2064-734	1/75	LED	24V	[F1]	P&R	1,50 m
31-2064-774	1/-	LED	24V	[G]	P&R	1,00 m
31-2067-084	-/-	LED	24V	[B2]	2 pol. ASS2 2 pin ASS2	1,50 m
31-2067-094	1/50	LED	24V	[B2]	3 pol. ASS3 3 pin ASS3	0,50 m
31-2067-104	1/50	LED	24V	[B2]	3 pol. ASS3 3 pin ASS3	1,50 m
31-2067-694	1/50	LED	24V	[F2]	3 pol. ASS3 3 pin ASS3	1,50 m
31-2104-014	1/100	LED	24V	[A3]	P&R	0,50 m
31-2104-034	1/-	LED	24V	[A3]	P&R	1,50 m
31-2164-014	1/100	LED	24V	[B3]	P&R	0,50 m
31-2164-034	-/-	LED	24V	[B3]	P&R	1,50 m



# UNIPOINT I LED

ADR Zone 2 IP 6K9K

[H]

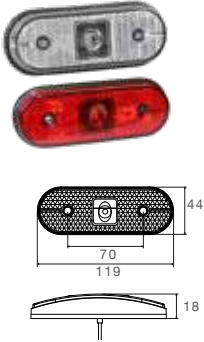

[I]

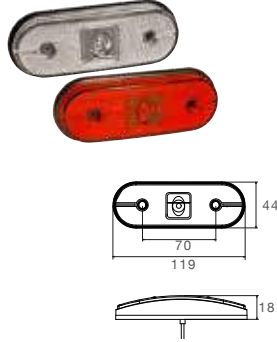

[J]

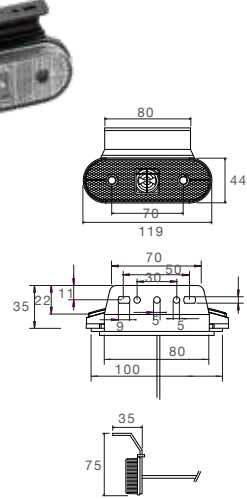

[K]

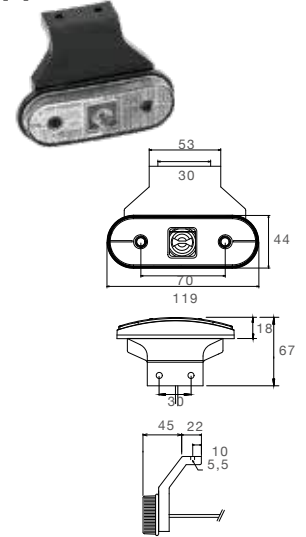

Positionslicht  
Position light

BEST. NR PART NO				ZUSATZ ADD ON			ANSCHLUSS CONNECTOR							
				[H]	[I]	[J]	[K]	Symbol	Symbol	Symbol	Symbol			
31-7704-014	1/-	LED	24V	[H]					P&R			0,50 m		
31-7704-034	1/40	LED	24V	[H]					P&R			1,50 m		
31-7704-054	1/50	LED	24V	[H]					P&R			3,50 m		
31-7704-094	1/-	LED	24V	[I]					P&R			0,50 m		
31-7704-124	1/25	LED	24V	[I]					P&R			3,50 m		
31-7707-034	1/-	LED	24V	[H]					2 pol. ASS2 2 pin ASS2				1,50 m	
31-7707-104	1/-	LED	24V	[H]					2 pol. ASS3 2 pin ASS3				0,50 m	
31-7707-114	1/-	LED	24V	[H]					2 pol. ASS3 2 pin ASS3				1,50 m	
31-7707-214	-/-	LED	24V	[H]					2 pol. ASS2 2 pin ASS2				0,50 m	
31-7764-014	1/-	LED	24V	[J]					P&R			0,50 m		
31-7764-214	-/-	LED	24V	[K]					P&R			0,50 m		
31-7764-234	1/50	LED	24V	[K]					P&R			1,50 m		
31-7804-014	1/100	LED	24V	[H]					P&R			0,50 m		
31-7804-054	1/-	LED	24V	[H]					P&R			3,50 m		
31-7804-094	1/-	LED	24V	[I]					P&R			0,50 m		
31-7804-124	1/25	LED	24V	[I]					P&R			3,50 m		
31-7804-144	1/-	LED	24V	[H]					P&R			5,00 m		



# UNIPOINT I LED

ZUBEHÖR / ACCESSORIES

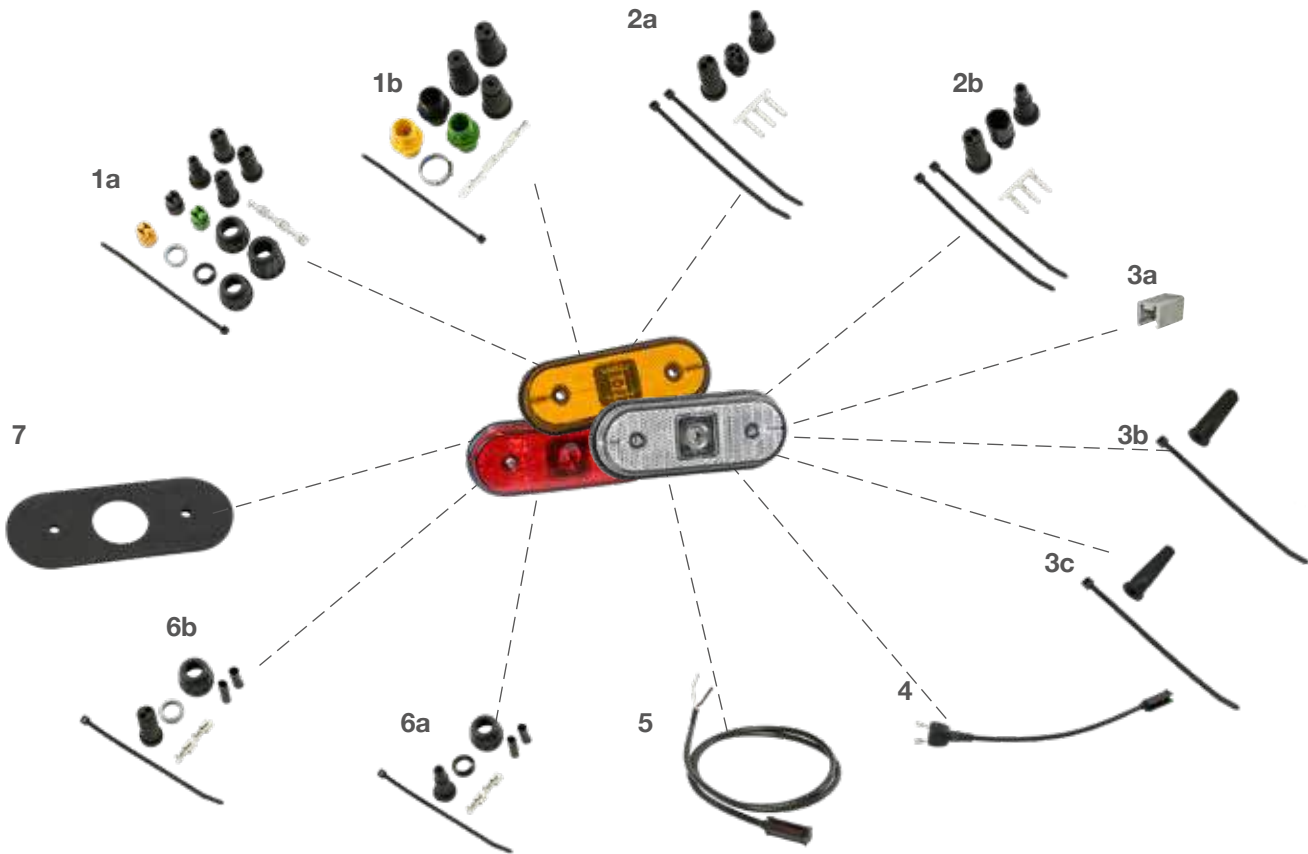

## 1 ASS1 & ASS2 Verbinder | ASS1 & ASS2 connector

- (a) 2 pol. weiblich  
2 pin female ..... 13-5626-401
- (b) 2 pol. männlich  
2 pin male ..... 13-5625-991

## 2 ASS3 Verbinder | ASS3 connector

- (a) 3 pol. weiblich  
3 pin female ..... 13-0322-281
- (b) 3 pol. männlich  
3 pin male ..... 13-0332-281

## 3 für P&R Verbinder | for P&R connector

- (a) Verschlusskappen  
caps ..... 15-5971-014
- (b) Endkappen rund  
end caps round ..... 15-5983-024
- (c) Endkappen eckig  
end caps square ..... 15-5729-014

## 4 Zuleitung mit P&R Verbinder | front connection with P&R connector

- 0,25 m ..... 68-5018-004
- 1,5 m ..... 68-5018-024

## 5 Anschlusskabel P&R | connection cable P&R

- 0,5 m ..... 68-5000-014
- 1,5 m ..... 68-5000-034

## 6 Anschluss | connector

- (a) Einfachtülle (lose)  
single grommet (loose) 15-5624-014
- (b) Doppeltülle (lose)  
double grommet (loose) 15-5624-024

## 7 Gummiunterlage | rubber base

- ..... 15-5319-904





## UNIPOINT I LED

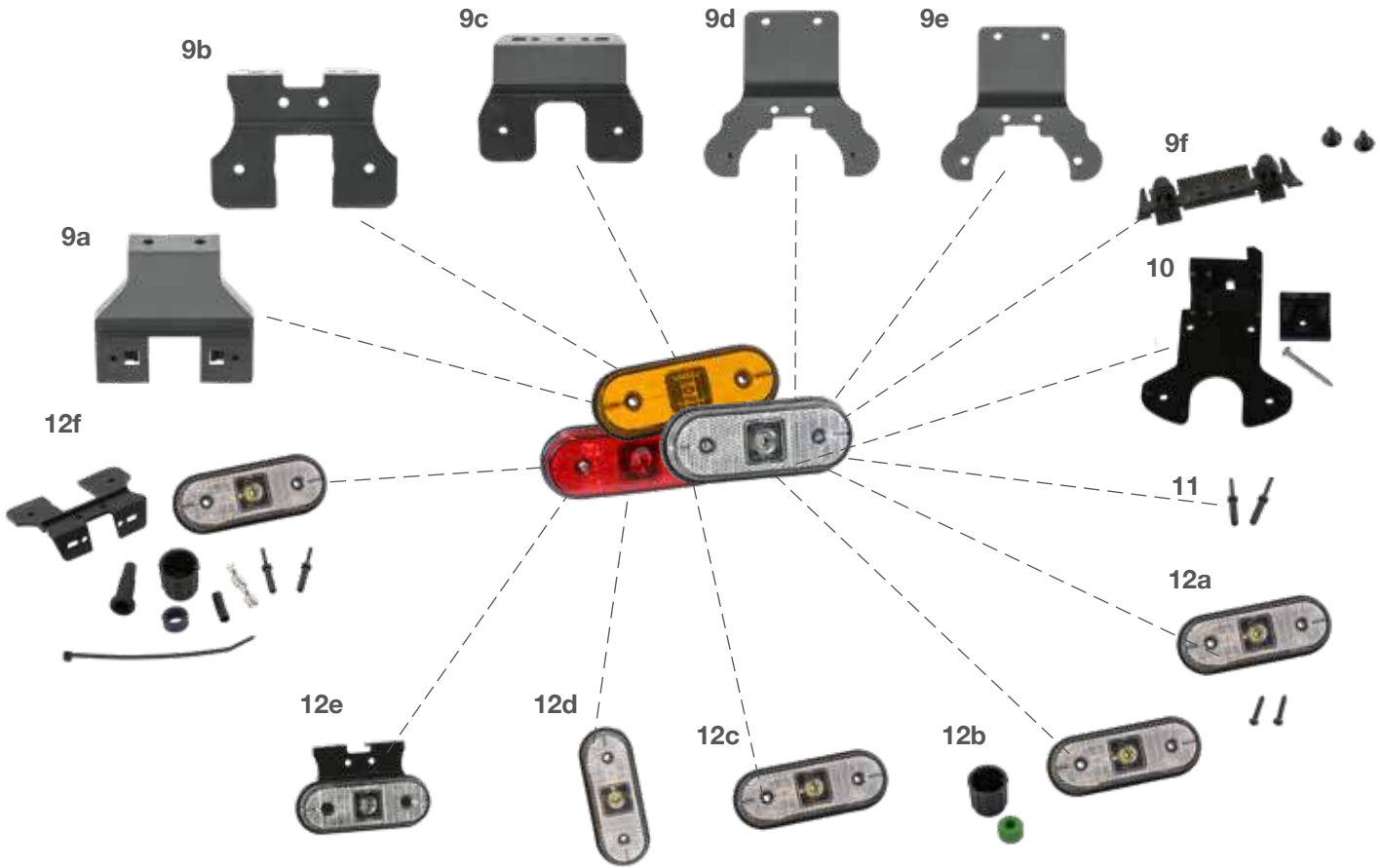

### 9 Haltewinkel | bracket

- (a) schräg nach hinten  
sloping angle to the back  
..... 15-5317-014
- (b) 90° nach hinten  
90° to the back  
..... 15-5319-004
- (c) schräg nach vorne  
sloping to the front  
..... 15-5319-304
- (d) Aufhängeteil gekröpft (Anbau mit Schrauben)  
crumpled bracket (screw mounting)  
..... 15-5317-004
- (e) Aufhängeteil gekröpft (Anbau mit Nieten)  
crumpled bracket (expanding rivet-mounting)  
..... 15-5317-024
- (f) Schnellhalter for SML  
quick fixation bracket for SML  
..... 15-2128-285

### 10 Verriegelungswinkel | locking bracket

- Verriegelungswinkel  
locking angle  
..... 15-5322-004

### 11 Spreizniete | expanding rivet

- 14-15 mm ..... 14-4596-004

### 12 Ersatzleuchte weiß ohne Schutzhaube | spare part lamp white without protection cap

- (a) mit Schrauben  
with screws ..... 21-7700-004
- (b) geschlossen mit Bajonett-Mutter  
closed by bayonet-nut  
..... 21-7700-014
- (c) Standard Version  
standard version ..... 21-7700-054
- (d) vertikal  
vertical ..... 21-7702-014
- (e) mit 90° Haltewinkel nach hinten  
with 90° bracket to the back  
..... 21-7700-024
- (f) mit 90° Haltewinkel nach hinten  
(komplett)  
with 90° bracket to the back  
(complete)  
..... 21-7700-035





# UNIPOINT | LED

ZUBEHÖR / ACCESSORIES

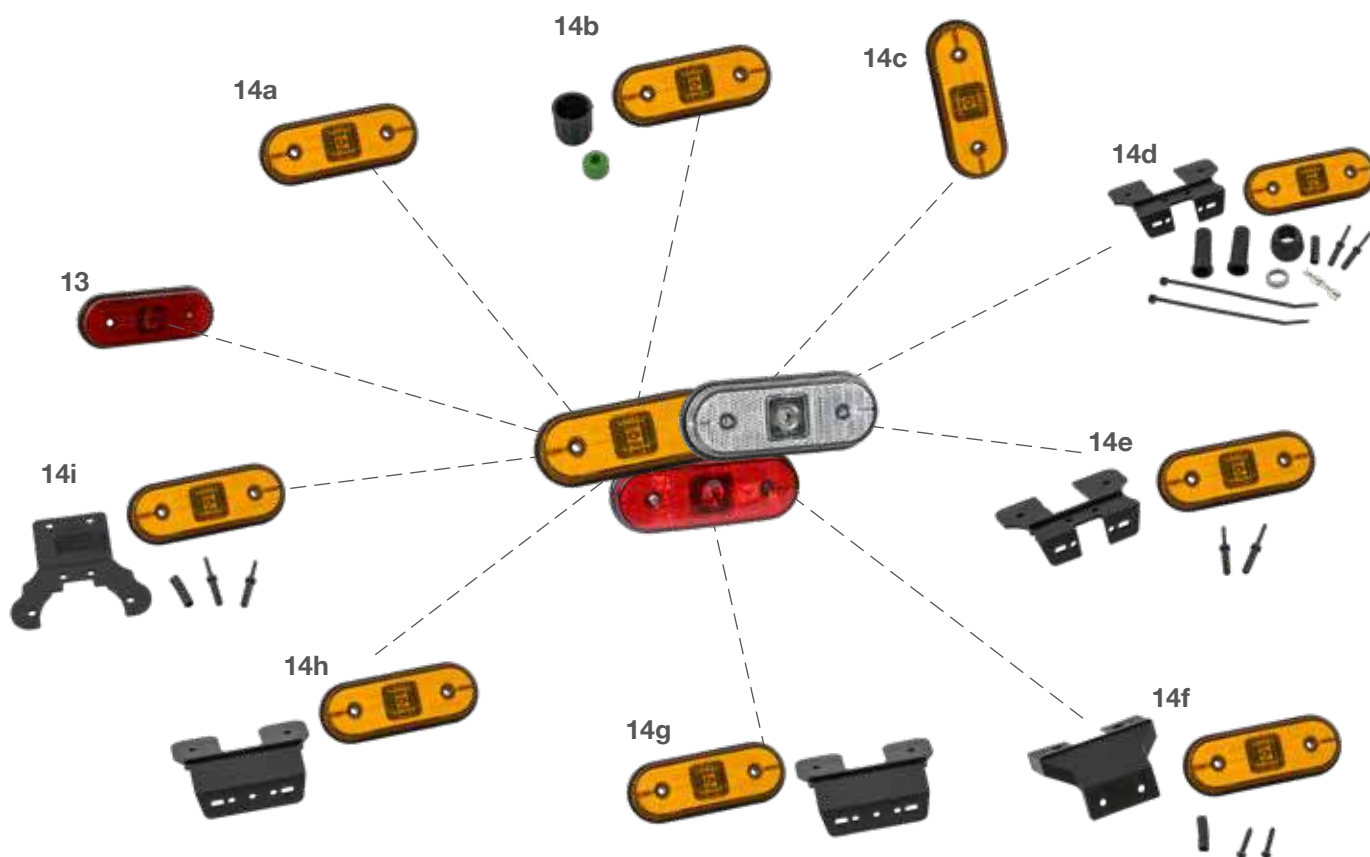

**13** Ersatzleuchte rot ohne Schutzhaube |  
spare part lamp red without protection cap  
mit Schrauben  
with screws ..... 21-7800-004

**14** Ersatzleuchte orange ohne Schutzhaube |  
spare part lamp orange without protection cap

(a) ohne Schrauben  
without screws..... 21-2000-154

(b) geschlossen mit Bajonett-Mutter  
closed by bayonet-nut  
..... 21-2000-144

(c) vertikal  
vertical..... 21-2002-004

(d) mit geradem Anschluss für SML mit  
90° Haltewinkel  
with straight connector for SML with  
90° bracket  
..... 21-2000-035

(e) lose mit 90° Haltewinkel  
loose with 90° bracket

..... 21-2000-014

(f) lose mit schrägem Haltewinkel  
loose with sloping bracket  
..... 21-2000-024

(g) mit flexiblen Haltewinkel  
with flexible bracket  
..... 21-2000-054

(h) mit flexiblen Haltewinkel und  
Schnellhalter  
with flexible bracket and quick-fixation bracket  
..... 21-2000-104

(i) mit Aufhängeteil  
with bracket..... 21-2000-064



# UNIPOINT DI





ADR Zone 2 IP 6K9K

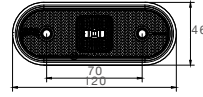

Produktinformation  
Product information



Seitenmarkierungslicht  
Sidemarker light

BEST. NR				ZUSATZ	ANSCHLUSS
PART NO				ADD ON	CONNECTOR
31-2100-134	1/-	LED	24V	↔	offenes Ende open end 1,50 m ↗
31-2104-074	1/-	LED	24V	↔	P&R   1,50 m ↗
31-2107-004	1/-	LED	24V	↔	2 pol. ASS3    2 pin ASS3 1,50 m ↗



# UNIPOINT DI

ZUBEHÖR / ACCESSORIES

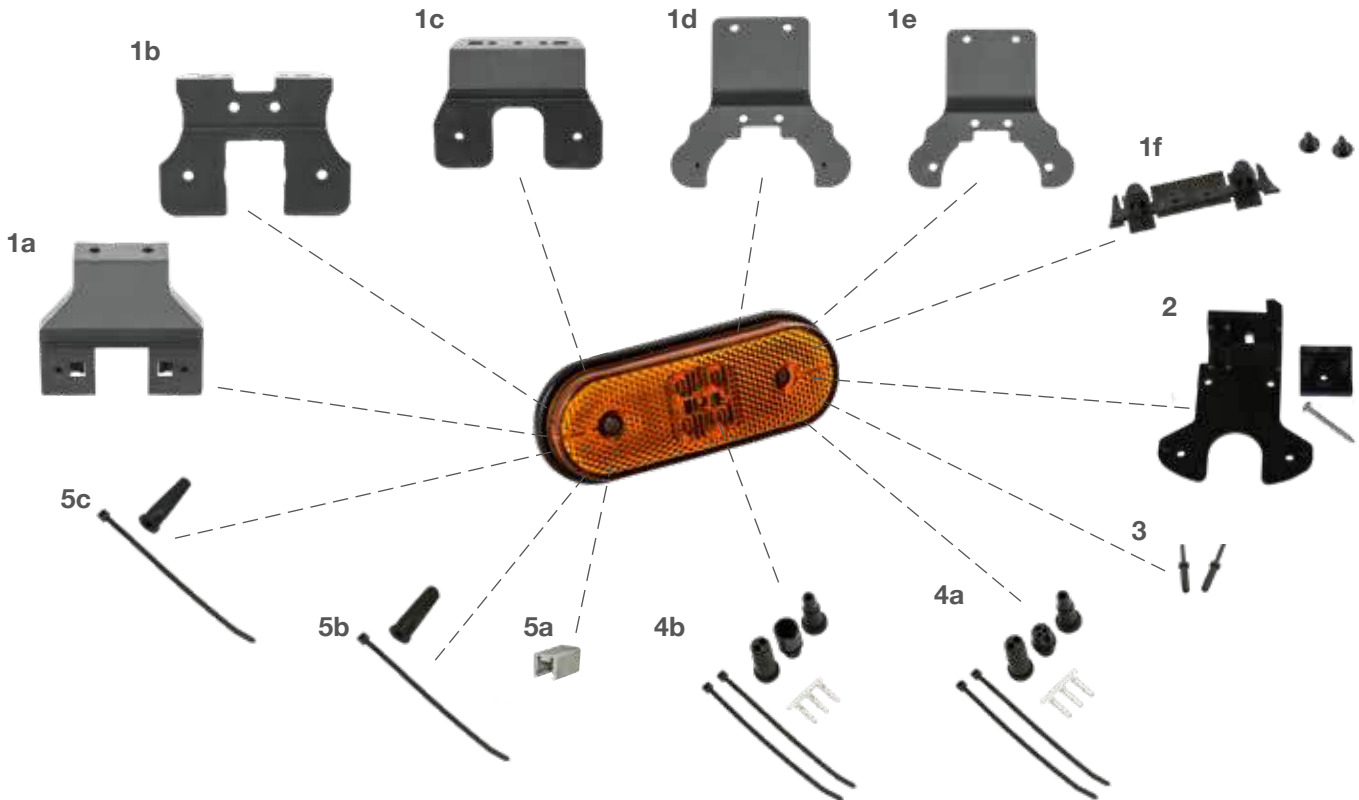

## 1 Haltewinkel | bracket

- (a) schräg nach hinten  
sloping angle to the back  
..... 15-5317-014
- (b) 90° nach hinten  
90° to the back  
..... 15-5319-004
- (c) schräg nach vorne  
sloping to the front  
..... 15-5319-304
- (d) Aufhängeteil gekröpft (Anbau mit Schrauben)  
crumped bracket (screw mounting)  
..... 15-5317-004
- (e) Aufhängeteil gekröpft (Anbau mit Nieten)  
crumped bracket (expanding rivet-mounting)  
..... 15-5317-024
- (f) Schnellhalter for SML  
quick fixation bracket for SML  
..... 15-2128-285

## 2 Verriegelungswinkel | locking bracket

- Verriegelungswinkel  
locking angle  
..... 15-5322-004

## 3 Spreizniete | expanding rivet

- 14-15 mm ..... 14-4596-004

## 4 ASS3 Verbinder | ASS3 connector

- (a) 3 pol. weiblich  
3 pin female ..... 13-0322-281
- (b) 3 pol. männlich  
3 pin male ..... 13-0332-281

## 5 für P&R Verbinder | for P&R connector

- (a) Verschlusskappen  
caps ..... 15-5971-014
- (b) Endkappen rund  
end caps round ..... 15-5983-024
- (c) Endkappen eckig  
end caps square ..... 15-5729-014



# UNIPOINT DI + SML

ADR Zone 2 IP 6K9K

[A]

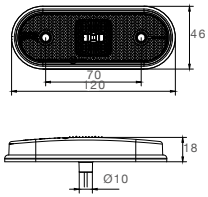

Seitenmarkierungslicht  
Sidemarker light

[B]

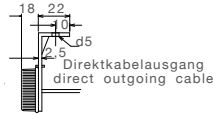
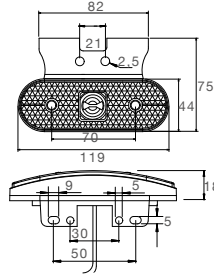

BEST. NR				ZUSATZ				ANSCHLUSS	
PART NO		LED	24V	ADD ON				CONNECTOR	
31-2100-034	-/-	LED	24V	[A]				offenes Ende open end	1,50 m
31-2107-014	-/-	LED	24V	[A]				3 pol. ASS3 3 pin ASS3	1,50 m
31-2107-024	1/-	LED	24V	[B]				3 pol. ASS3 3 pin ASS3	1,50 m



# UNIPOINT DI + SML

ZUBEHÖR / ACCESSORIES

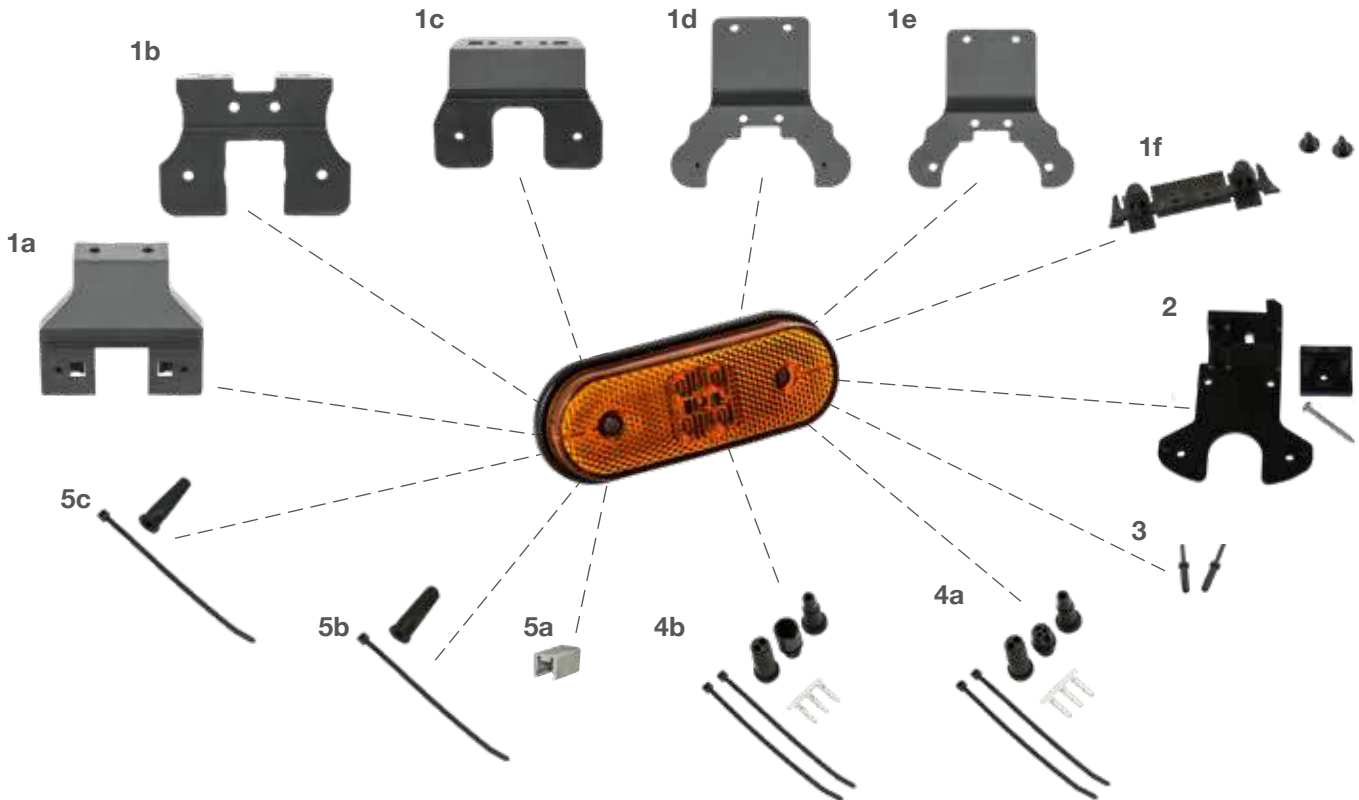

## 1 Haltewinkel | bracket

- (a) schräg nach hinten  
sloping angle to the back  
..... 15-5317-014
- (b) 90° nach hinten  
90° to the back  
..... 15-5319-004
- (c) schräg nach vorne  
sloping to the front  
..... 15-5319-304
- (d) Aufhängeteil gekröpft (Anbau mit Schrauben)  
crumped bracket (screw mounting)  
..... 15-5317-004
- (e) Aufhängeteil gekröpft (Anbau mit Nieten)  
crumped bracket (expanding rivet-mounting)  
..... 15-5317-024
- (f) Schnellhalter for SML  
quick fixation bracket for SML  
..... 15-2128-285

## 2 Verriegelungswinkel | locking bracket

- Verriegelungswinkel  
locking angle  
..... 15-5322-004

## 3 Spreizniete | expanding rivet

- 14-15 mm ..... 14-4596-004

## 4 ASS3 Verbinder | ASS3 connector

- (a) 3 pol. weiblich  
3 pin female ..... 13-0322-281
- (b) 3 pol. männlich  
3 pin male ..... 13-0332-281

## 5 für P&R Verbinder | for P&R connector

- (a) Verschlusskappen  
caps ..... 15-5971-014
- (b) Endkappen rund  
end caps round ..... 15-5983-024
- (c) Endkappen eckig  
end caps square ..... 15-5729-014



# UNIPOINT MAXX LED

ADR Zone 2 IP 6K9K



Produktinformation  
Product information

Positionslampe  
Position Lamp

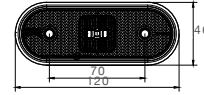

Seitenmarkierungslicht  
Sidemarker light

BEST. NR PART NO				ZUSATZ ADD ON	ANSCHLUSS CONNECTOR
31-2104-064	1/-	LED	24V		P&R   2,00 m



# UNIPOINT MAXX LED

ZUBEHÖR / ACCESSORIES

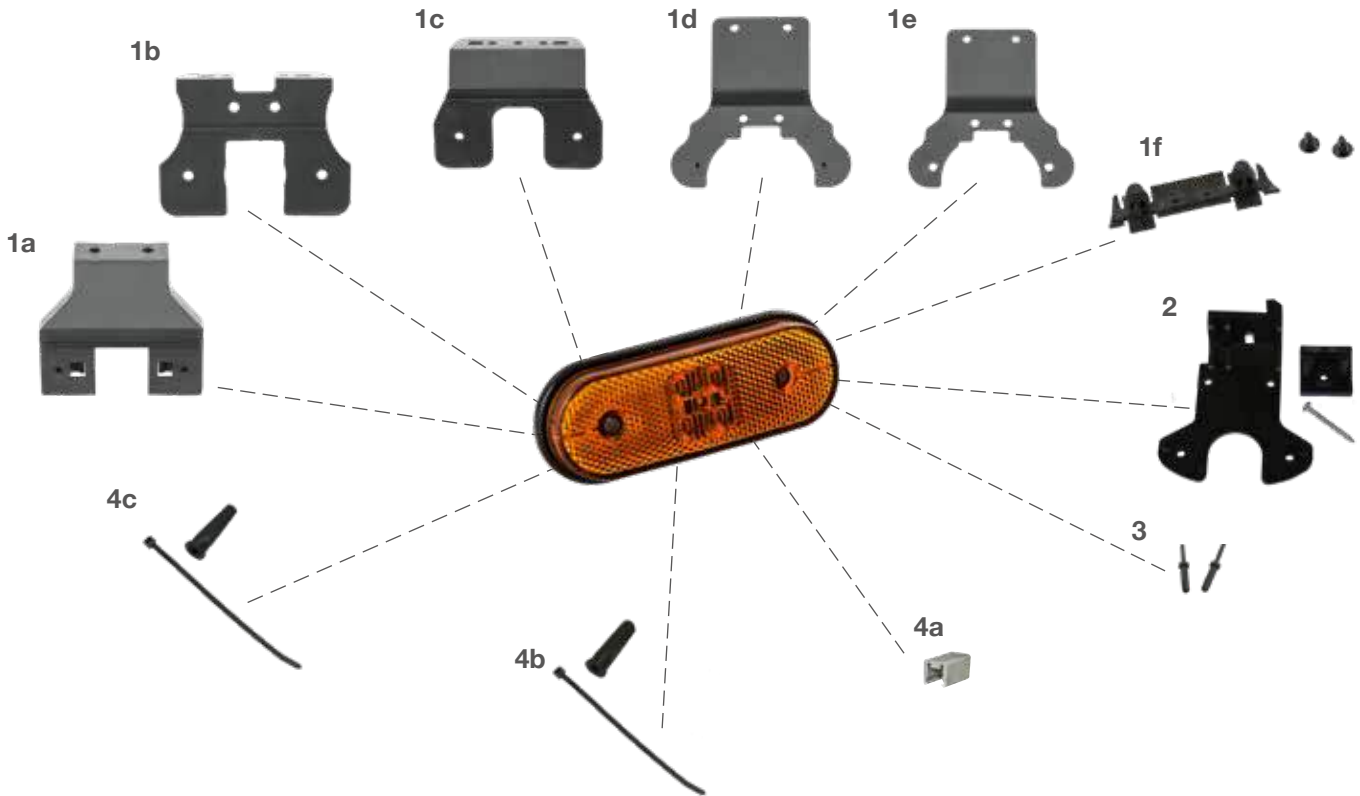

- 1 Haltewinkel | bracket**
- (a) schräg nach hinten  
sloping angle to the back  
..... 15-5317-014
  - (b) 90° nach hinten  
90° to the back  
..... 15-5319-004
  - (c) schräg nach vorne  
sloping to the front  
..... 15-5319-304
  - (d) Aufhängeteil gekröpft (Anbau mit Schrauben)  
crumped bracket (screw mounting)  
..... 15-5317-004
  - (e) Aufhängeteil gekröpft (Anbau mit Nieten)  
crumped bracket (expanding rivet-mounting)  
..... 15-5317-024
  - (f) Schnellhalter for SML  
quick fixation bracket for SML  
..... 15-2128-285

- 2 Verriegelungswinkel | locking bracket**
- Verriegelungswinkel  
locking angle  
..... 15-5322-004

- 3 Spreizniete | expanding rivet**
- 14-15 mm ..... 14-4596-004

- 4 für P&R Verbinder | for P&R connector**
- (a) Verschlusskappen  
caps ..... 15-5971-014
  - (b) Endkappen rund  
end caps round ..... 15-5983-024
  - (c) Endkappen eckig  
end caps square ..... 15-5729-014



# SIDEPPOINT

ADR  
Zone 2

IP 68

[A]

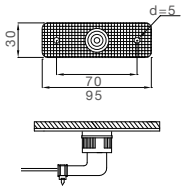

[B]

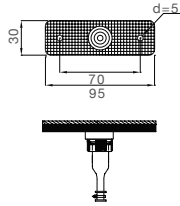

[C]

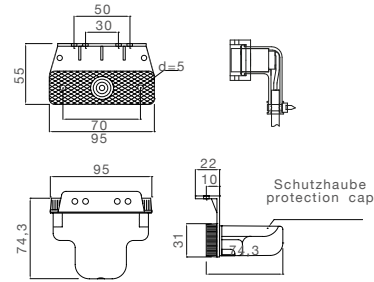

[D]

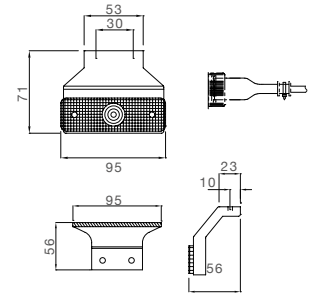

BEST. NR				ZUSATZ				ANSCHLUSS
PART NO				ADD ON				CONNECTOR
31-5004-014	-/-		24V	[A]				P&R  0,50 m
31-5004-094	1/-		24V	[B]				P&R  0,50 m
31-5004-104	1/-		24V	[B]				P&R  1,50 m
31-5004-154	1/-		24V	[A]				P&R  0,25 m
31-2804-094	1/-		24V	[A]				P&R  0,50 m
31-2804-174	1/-		24V	[B]				P&R  1,50 m
31-2814-004	1/50		24V	[C]				Schutzhaube protection cap P&R  0,50 m
31-2814-024	1/50		24V	[C]				Schutzhaube protection cap P&R  1,50 m
31-2864-004	1/-		24V	[D]				P&R  0,50 m
31-2864-034	1/50		24V	[D]				P&R  1,50 m





# SIDEPOINT

ZUBEHÖR / ACCESSORIES

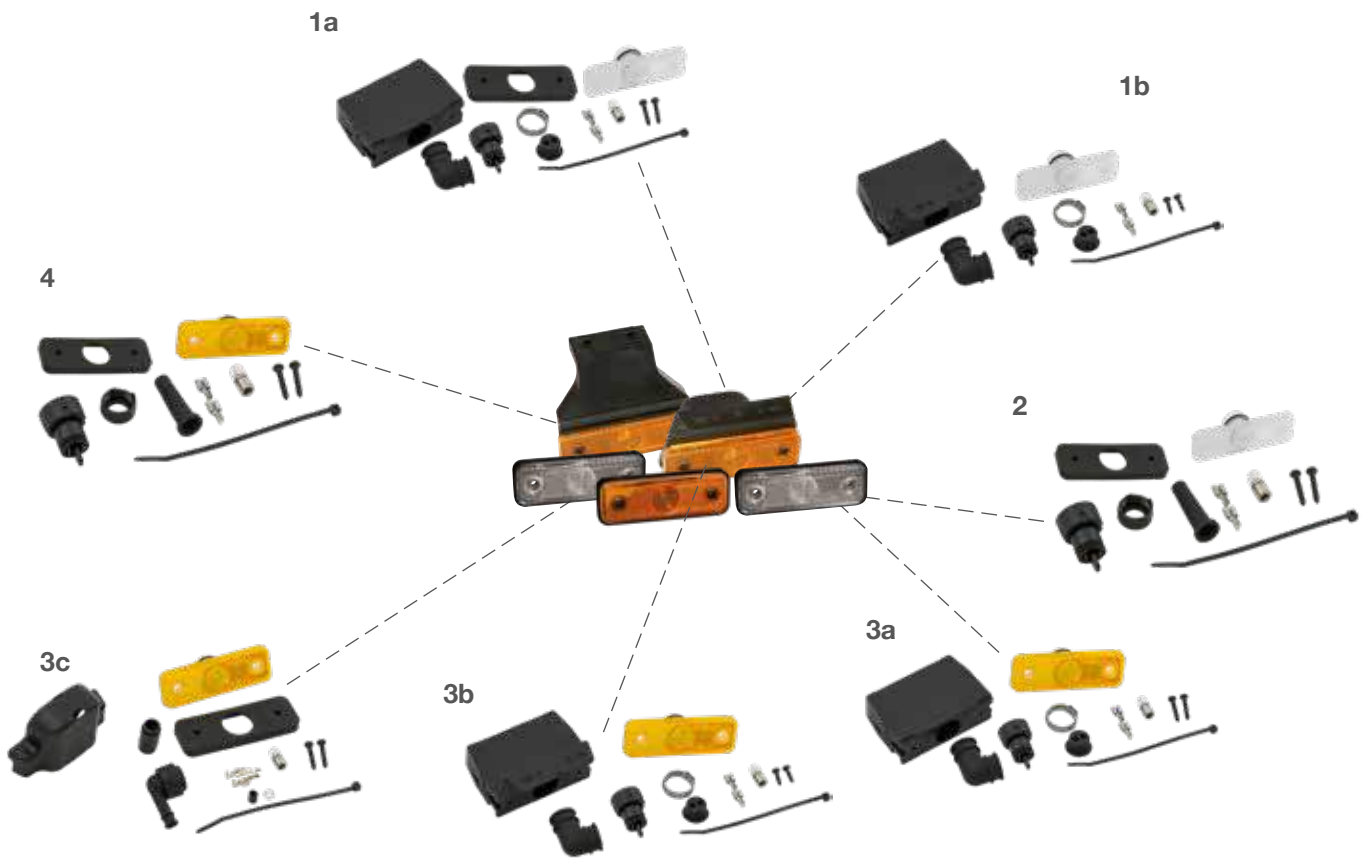

## 1 Ersatzleuchte weiß mit Schutzhaube | spare part lamp white with protection cap

(a) mit 90° Anschluss ohne Haltewinkel  
with 90° connector without bracket  
..... 21-5000-004

(b) mit 90° Anschluss und 90° Haltewinkel  
with 90° connector and 90° bracket  
..... 21-5000-034

## 2 Ersatzleuchte weiß ohne Schutzhaube | spare part lamp white without protection cap

mit geradem Anschluss ohne Haltewinkel  
with straight connector without bracket  
..... 21-5000-054

## 3 Ersatzleuchte orange mit Schutzhaube | spare part lamp orange with protection cap

(a) mit 90° Anschluss ohne Haltewinkel  
with 90° connector without bracket  
..... 21-2801-004

(b) mit 90° Anschluss und 90° Haltewinkel  
with 90° connector and 90° bracket  
..... 21-2800-014

(c) mit 90° Anschluss und Schutzhaube  
with 90° connector and with protection cap  
..... 21-2801-064

## 4 Ersatzleuchte orange ohne Schutzhaube | spare part lamp orange without protection cap

mit geradem Anschluss ohne Haltewinkel  
with straight connector without bracket  
..... 21-2801-054



# SIDEPOINT

ZUBEHÖR / ACCESSORIES

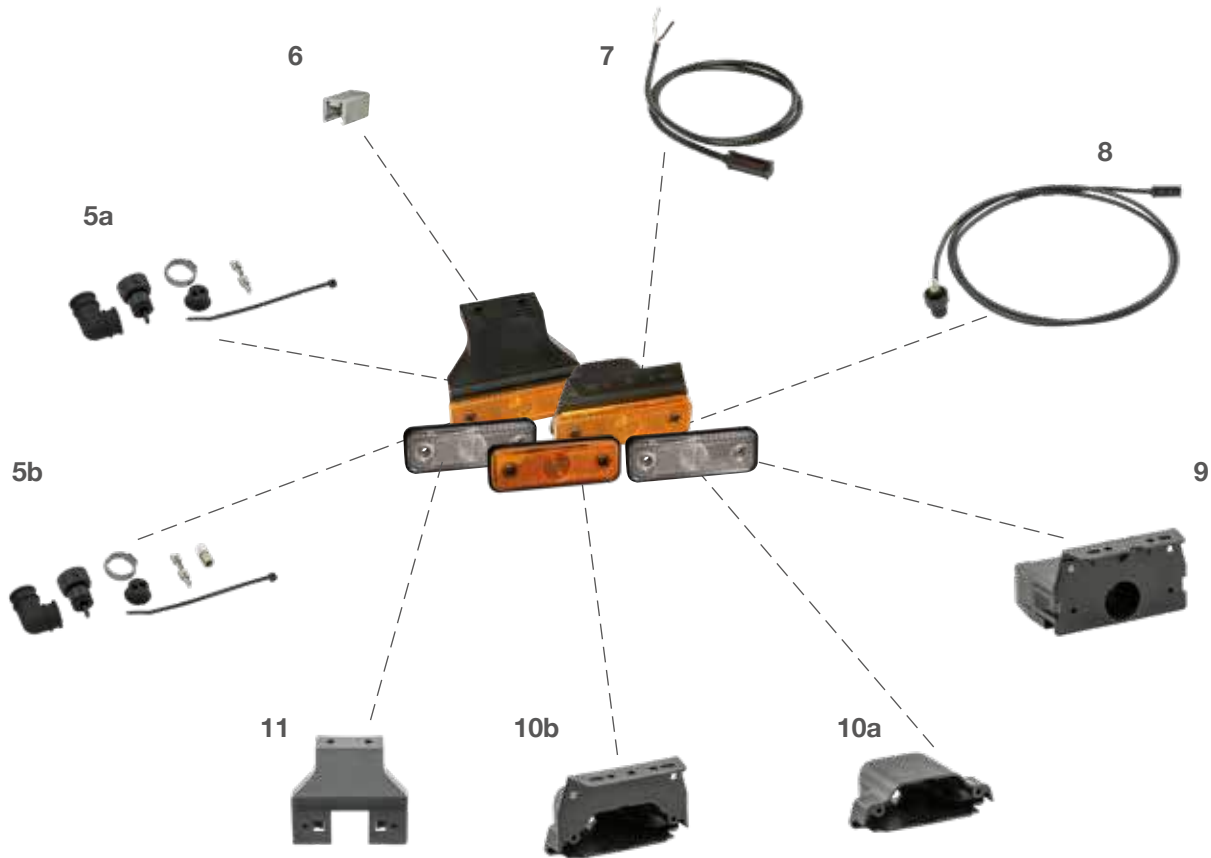

## 5 Anschluss | connector

- (a) ohne Glühlampe  
without bulb..... 15-2128-524
- (b) mit Glühlampe  
with bulb..... 15-2128-514

## 6 Verschlusskappen für P&R Verbinder | caps for P&R connector

- ..... 15-5971-014

## 7 Anschlusskabel P&R | connection cable P&R

- 0,50 m..... 68-5000-014
- 1,50 m..... 68-5000-034

## 8 Zuleitung P&R mit Anschluss und Gehäuse für Fassung | front connection P&R with connector and housing for lamp socket

- 2,00 m ..... 31-2804-204

## 9 Sockel mit Winkel und Schutzhaube | socket with bracket and protection cap

- ..... 15-2128-274

## 10 Schutzhaube | protection cap

- (a) ohne Haltewinkel  
without bracket..... 15-2122-164
- (b) mit 90° Haltewinkel  
with 90° bracket..... 15-2122-174

## 11 Haltewinkel | bracket

- schräg  
sloping..... 15-2128-144



# POSIPOINT II LED

ADR Zone 2 IP 6K9K

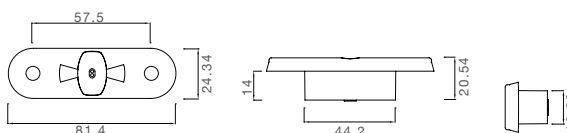



BEST. NR				ZUSATZ	ANSCHLUSS	
PART NO				ADD ON	CONNECTOR	
31-7100-004	1/-	LED	12V 24V		offenes Ende open end	5,00 m
31-7100-014	1/20	LED	12V 24V		offenes Ende open end	3,50 m
31-7100-034	1/-	LED	12V 24V		offenes Ende open end	1,50 m
31-7100-054	1/-	LED	12V 24V	MAN Version	2 pol. AFS lear 2 pin AFS lear	0,30 m
31-7100-064	1/-	LED	12V 24V		offenes Ende open end	0,50 m
31-7100-114	1/-	LED	12V 24V	mit 7,50 m Wellrohr with 7,50 m corrugated pipe	offenes Ende open end	8,00 m
31-7104-004	1/-	LED	12V 24V		P&R	0,50 m
31-7104-014	1/50	LED	12V 24V		P&R	1,50 m
31-7104-024	1/20	LED	12V 24V		P&R	3,50 m
31-7104-034	1/-	LED	12V 24V	mit Verschlusskappe with cap	P&R	5,00 m
31-7104-054	-/-	LED	12V 24V		P&R	0,15 m
31-7107-014	-/-	LED	12V 24V		2 pol. ASS2 2 pin ASS2	1,30 m
31-7110-004	1/15	LED	12V 24V	mit 7,50 m Wellrohr with 7,50 m corrugated pipe	offenes Ende open end	8,00 m
31-7204-014	1/-	LED	12V 24V		P&R	1,50 m
31-7204-024	1/-	LED	12V 24V		P&R	3,50 m
31-7204-044	1/50	LED	12V 24V		P&R	5,00 m
31-7207-014	1/25	LED	12V 24V		2 pol. ASS3 2 pin ASS3	0,50 m
31-7210-004	1/-	LED	12V 24V	mit 0,30 m Wellrohr with 0,30 m corrugated pipe	offenes Ende open end	0,80 m

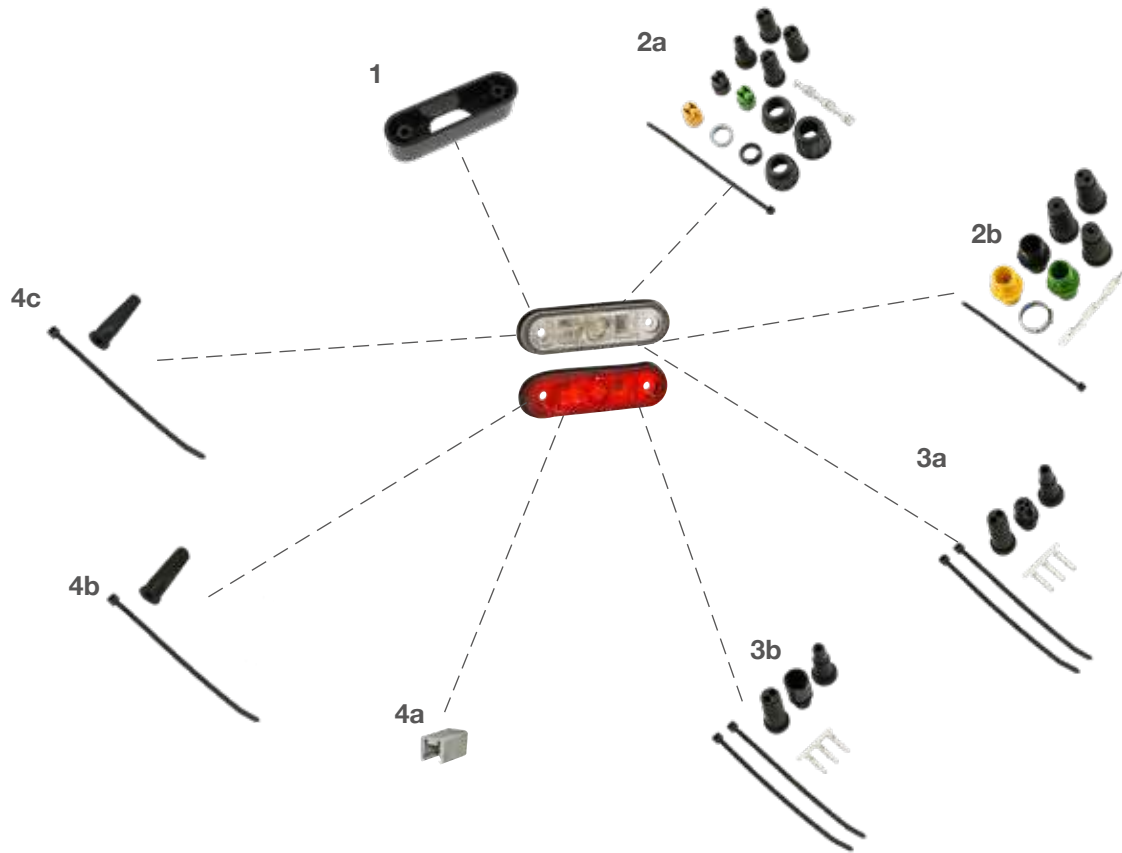

# POSIPOINT II LED

ZUBEHÖR / ACCESSORIES



**1** Gehäuse | housing  
..... 15-5609-104 

**2** ASS1 & ASS2 Verbinder |  
ASS1 & ASS2 connector  
(a) 2 pol. weiblich  
2 pin female ..... 13-5626-401   
(b) 2 pol. männlich  
2 pin male ..... 13-5625-991 

**3** ASS3 Verbinder | ASS3 connector  
(a) 3 pol. weiblich  
3 pin female ..... 13-0322-281   
(b) 3 pol. männlich  
3 pin male ..... 13-0332-281 

**4** für P&R Verbinder |  
for P&R connector  
(a) Verschlusskappen  
caps ..... 15-5971-014   
(b) Endkappen rund  
end caps round ..... 15-5983-024   
(c) Endkappen eckig  
end caps square ..... 15-5729-014 

**4** Dichtungsring |  
sealing ring  
..... 15-5113-004 









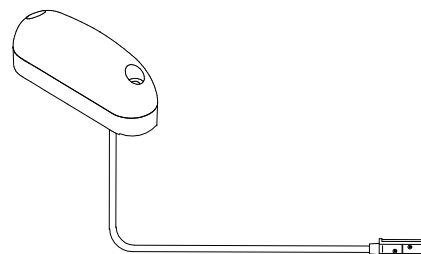
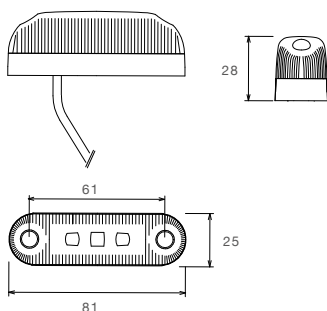





# POSIPOINT I LED

ADR Zone 2 IP 6K9K



 Positionslight  
Position Light

BEST. NR				ZUSATZ	ANSCHLUSS
PART NO				ADD ON	CONNECTOR
31-6004-074	1/-	LED	24V	 	P&R  0,50 m 
31-6204-084	1/-	LED	24V	 	P&R  0,50 m 



# POSIPOINT I LED

ZUBEHÖR / ACCESSORIES

Positionslampe  
Position Lamp

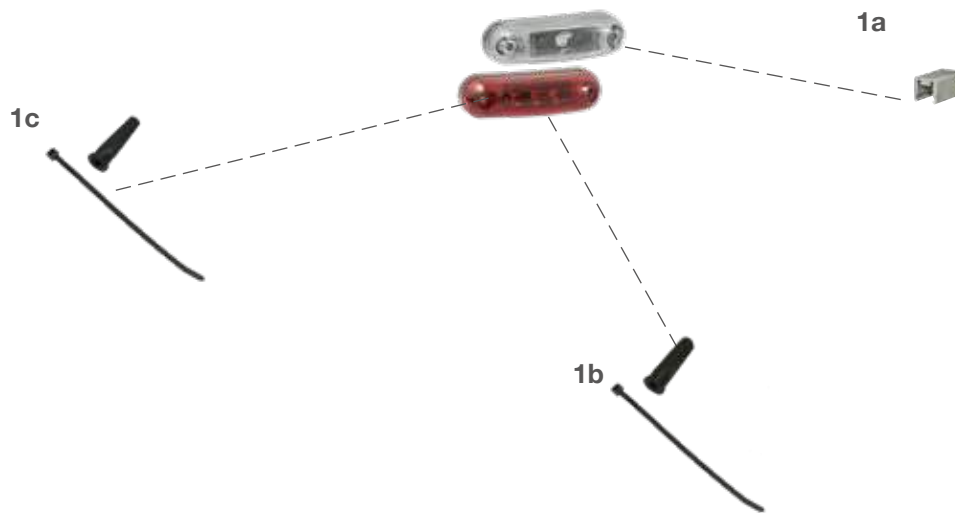

## 1 für P&R Verbinder I for P&R connector

- (a) Verschlusskappen  
caps..... 15-5971-014
- (b) Endkappen rund  
end caps round..... 15-5983-024
- (c) Endkappen eckig  
end caps square..... 15-5729-014



# MONOPOINT II LED

ADR Zone 2 IP 6K9K

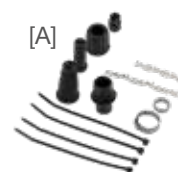
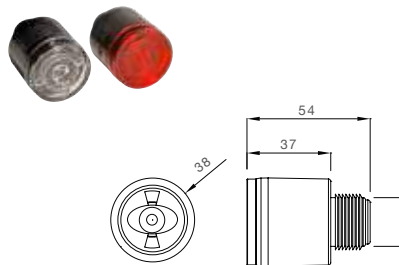
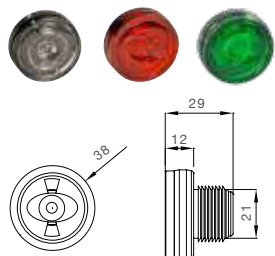

BEST. NR				ZUSATZ	ANSCHLUSS	
PART NO				ADD ON	CONNECTOR	
31-6700-024	1/-	LED	12V 24V		offenes Ende open end	3,50 m
31-6704-064	1/-	LED	12V 24V		P&R	0,50 m
31-6704-074	1/-	LED	12V 24V		P&R	1,50 m
31-6704-084	1/-	LED	12V 24V		P&R	3,50 m
31-6704-124	1/-	LED	12V 24V		P&R	5,00 m
31-6704-204	1/-	LED	12V 24V		P&R	1,70 m
31-6707-054	-/-	LED	12V 24V		3 pol. ASS3 3 pin ASS3	1,50 m
31-6700-044	1/-	LED	12V 24V		2 pol. MKR plus Lear 2 pin MKR plus Lear	0,50 m
31-6700-064	-/-	LED	12V 24V		2 pol. Superseal 2 pin Superseal	0,25 m
31-6700-014	1/-	LED	12V 24V	+ [A]	offenes Ende open end	3,70 m
31-6700-034	1/10	LED	12V 24V		offenes Ende open end	3,50 m
31-6704-094	1/-	LED	12V 24V		P&R	0,50 m
31-6704-104	1/-	LED	12V 24V		P&R	1,50 m
31-6704-114	1/-	LED	12V 24V		P&R	3,50 m







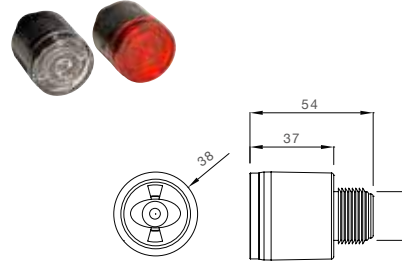
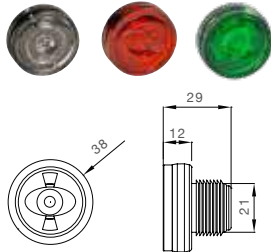



























# MONOPOINT II LED

ADR Zone 2 IP 6K9K



 Positionslight  
Position Light

BEST. NR PART NO				ZUSATZ ADD ON	ANSCHLUSS CONNECTOR	
31-6800-014	1/-	LED	12V 24V	 	offenes Ende open end	3,50 m 
31-6804-064	1/-	LED	12V 24V	 	P&R 	3,50 m 
31-6804-084	1/-	LED	12V 24V	 	P&R 	0,50 m 
31-6804-094	-/-	LED	12V 24V	 	P&R 	5,00 m 
31-6807-014	-/-	LED	12V 24V	 	3 pol. ASS3 3 pin ASS3   	0,50 m 
31-6804-074	1/-	LED	12V 24V	 	P&R 	3,50 m 
31-7400-004	-/-	LED	12V 24V		offenes Ende open end	3,50 m 
31-7400-014	-/-	LED	12V 24V		offenes Ende open end	1,00 m 







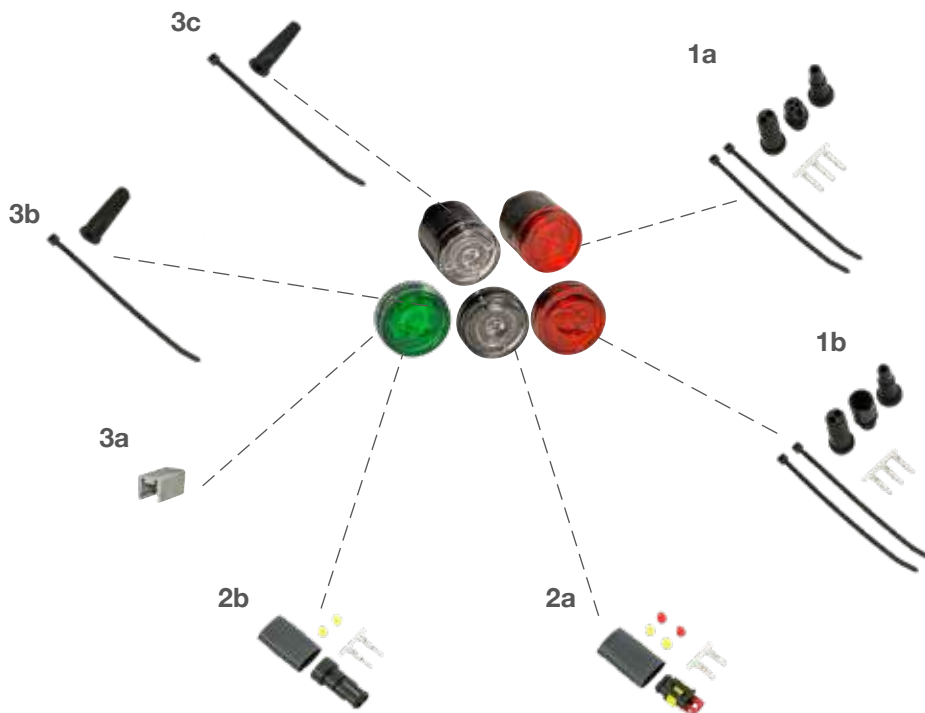

# MONOPOINT II LED

ZUBEHÖR / ACCESSORIES



- 1 ASS3 Verbinder | ASS3 connector**
- (a) 3 pol. weiblich  
3 pin female ..... 13-0322-281 
  - (b) 3 pol. männlich  
3 pin male ..... 13-0332-281 
- 2 Superseal Verbinder | Superseal connector**
- (a) 2 pol. weiblich  
2 pin female ..... 15-7002-044 
  - (b) 2 pol. männlich  
2 pin male ..... 15-7002-054 

- 3 für P&R Verbinder | for P&R connector**
- (a) Verschlusskappen  
caps ..... 15-5971-014 
  - (b) Endkappen rund  
end caps round ..... 15-5983-024 
  - (c) Endkappen eckig  
end caps square ..... 15-5729-014 



# MONOPOINT I LED

ADR Zone 2 IP6K9K

Positionslampe  
Position Lamp

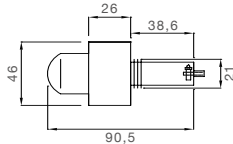

BEST. NR				ZUSATZ	ANSCHLUSS
PART NO				ADD ON	CONNECTOR
31-6704-014	1/-	LED	12V 24V		P&R  0,50 m
31-6704-054	1/10	LED	12V 24V		P&R  3,50 m
31-6707-044	-/-	LED	12V 24V		3 pol. ASS3   3,50 m
31-6707-004	1/50	LED	12V 24V		2 pol. ASS2   1,50 m
31-6804-014	1/-	LED	12V 24V		P&R  0,50 m
31-6807-024	1/50	LED	12V 24V		3 pol. ASS3   0,50 m



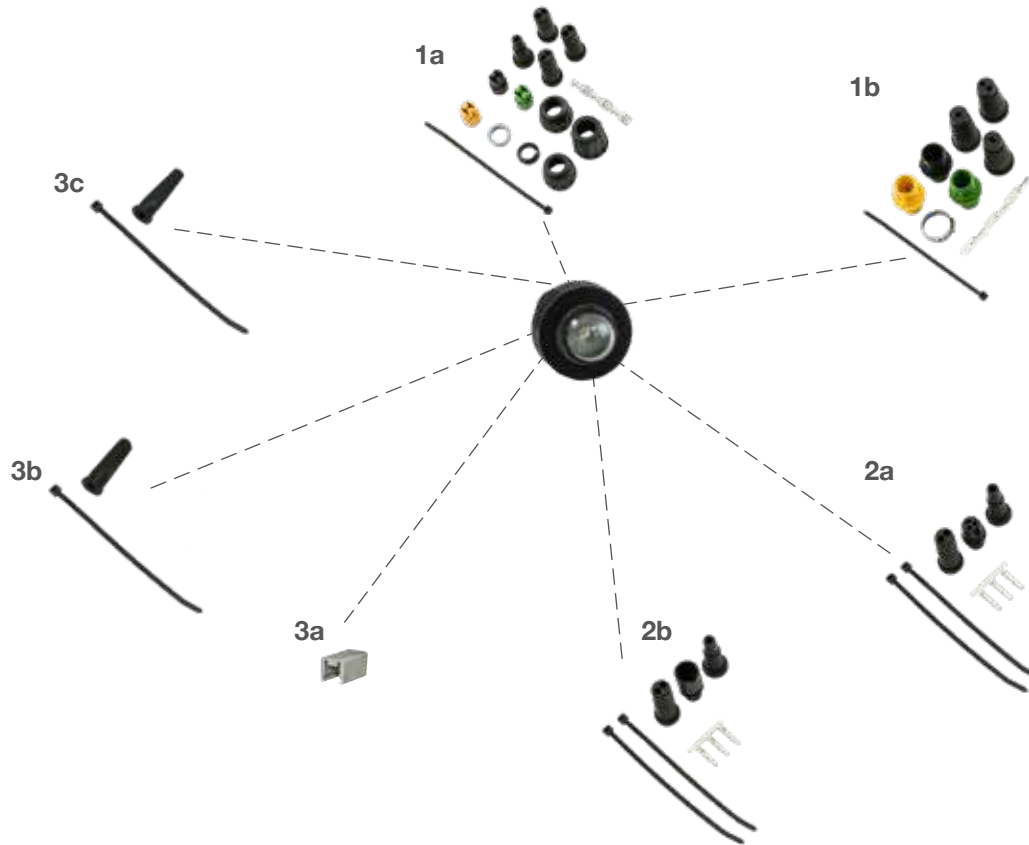

# MONOPOINT | LED

ZUBEHÖR / ACCESSORIES



## 1 ASS1 & ASS2 Verbinder | ASS1 & ASS2 connector

- (a) 2 pol. weiblich  
2 pin female ..... 13-5626-401 
- (b) 2 pol. männlich  
2 pin male ..... 13-5625-991 

## 2 ASS3 Verbinder | ASS3 connector

- (a) 3 pol. weiblich  
3 pin female ..... 13-0322-281 
- (b) 3 pol. männlich  
3 pin male ..... 13-0332-281 

## 3 für P&R Verbinder | for P&R connector

- (a) Verschlusskappen  
caps ..... 15-5971-014 
- (b) Endkappen rund  
end caps round ..... 15-5983-024 
- (c) Endkappen eckig  
end caps square ..... 15-5729-014 



ASPÖCK®  
S T E M S



## KENNZEICHENLEUCHE

Unsere Lichtlösungen fördern Sicherheit und Sichtbarkeit gleichermaßen. Unterschiedliche Ausführungen und Anbaumöglichkeiten begünstigen ihre Vielseitigkeit. Verschiedene Anschlüsse verbinden die Leuchten einfach und schnell mit dem vorhandenen Kabelsystem. Einfachste Montage ist daher sichergestellt.

## NUMBER PLATE LAMP

Our lighting solutions encourage safety and visibility in equal measure. Different designs and installation options promote their versatility. Various connections connect the luminaires easily and quickly to the existing cable system. Simplest mounting is therefore ensured.

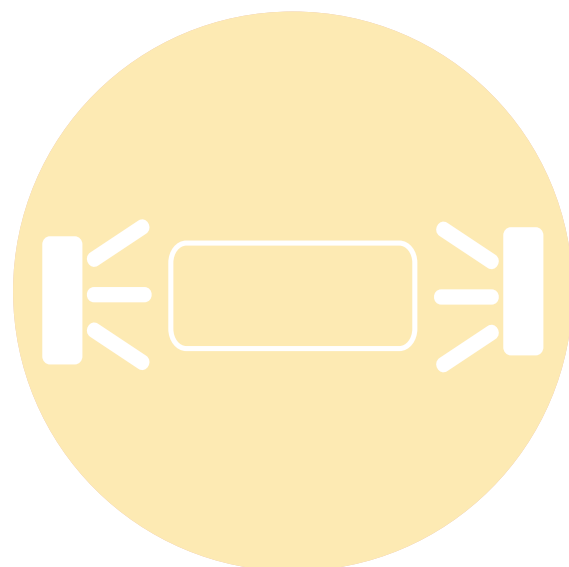



# NUMBER PLATE HOLDER FLEXLED

ADR Zone 2

IP 54



Produktinformation  
Product information

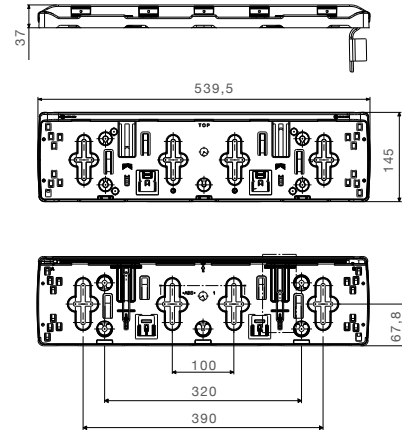

Kennzeichenlicht  
Number plate light

Kennzeichen-  
leuchte  
Number Plate  
Lamp

BEST. NR					ZUSATZ	ANSCHLUSS
PART NO					ADD ON	CONNECTOR
36-3704-101	1/-	LED	24V			offenes Ende open End 0,50 m
36-3704-141	1/-	LED	24V			P&R  0,50 m
36-3704-131	1/-	LED	24V			2 pol. ASS2 2 pin ASS2   0,50 m
36-3704-151	1/-	LED	24V			2 pol. Superseal 2 pin Superseal   0,50 m
36-3704-191	1/-	LED	24V			offenes Ende open End 1,50 m
36-3704-111	1/-	LED	24V			P&R  1,50 m
36-3704-171	1/-	LED	24V			2 pol. ASS2 2 pin ASS2   1,50 m
36-3704-181	1/-	LED	24V			2 pol. Superseal 2 pin Superseal   1,50 m



# NUMBER PLATE HOLDER FLEXLED

ZUBEHÖR / ACCESSORIES



- 1** Montage-Clip |  
Mounting clip  
..... 15-5300-424 





# REGPOINT II LED

ADR  
Zone 2

IP 54



Produktinformation  
Product information

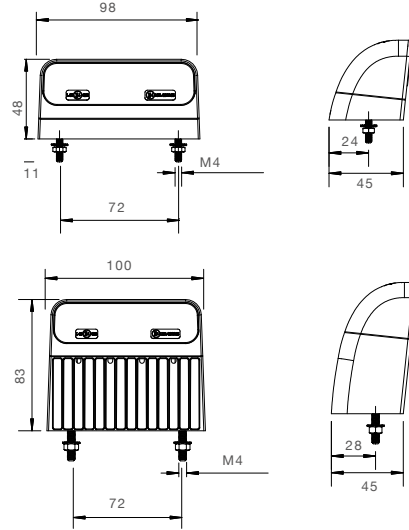

Kennzeichenlicht  
Number plate light

Kennzeichen-  
leuchte  
Number Plate  
Lamp

BEST. NR					ZUSATZ	ANSCHLUSS
PART NO					ADD ON	CONNECTOR
36-3804-004	1/50	LED	12V 24V			P&R  0,50 m
36-3804-014	1/25	LED	12V 24V			P&R  2,00 m
36-3806-004	1/-	LED	12V 24V			2 pol. ASS2  0,50 m
36-3805-004	1/-	LED	12V 24V			2 pol. ASS2  2,00 m
36-3807-004	1/-	LED	12V 24V			2 pol. Superseal  0,50 m
36-3810-004	1/-	LED	12V 24V			3 pol. ASS3  0,50 m
36-3864-004	1/-	LED	12V 24V		für Einzelbau for single mounting	P&R  0,50 m
36-3864-014	1/-	LED	12V 24V		für Einzelbau for single mounting	P&R  2,00 m
36-3867-014	1/-	LED	12V 24V		für Einzelbau for single mounting	2 pol. ASS2  0,50 m
36-3867-024	1/-	LED	12V 24V		für Einzelbau for single mounting	2 pol. ASS2  2,00 m
36-3865-004	1/-	LED	12V 24V		für Einzelbau for single mounting	3 pol. ASS3  0,50 m
36-3867-004	1/-	LED	12V 24V		für Einzelbau for single mounting	2 pol. Superseal  0,50 m





# REGPOINT II LED

ZUBEHÖR / ACCESSORIES

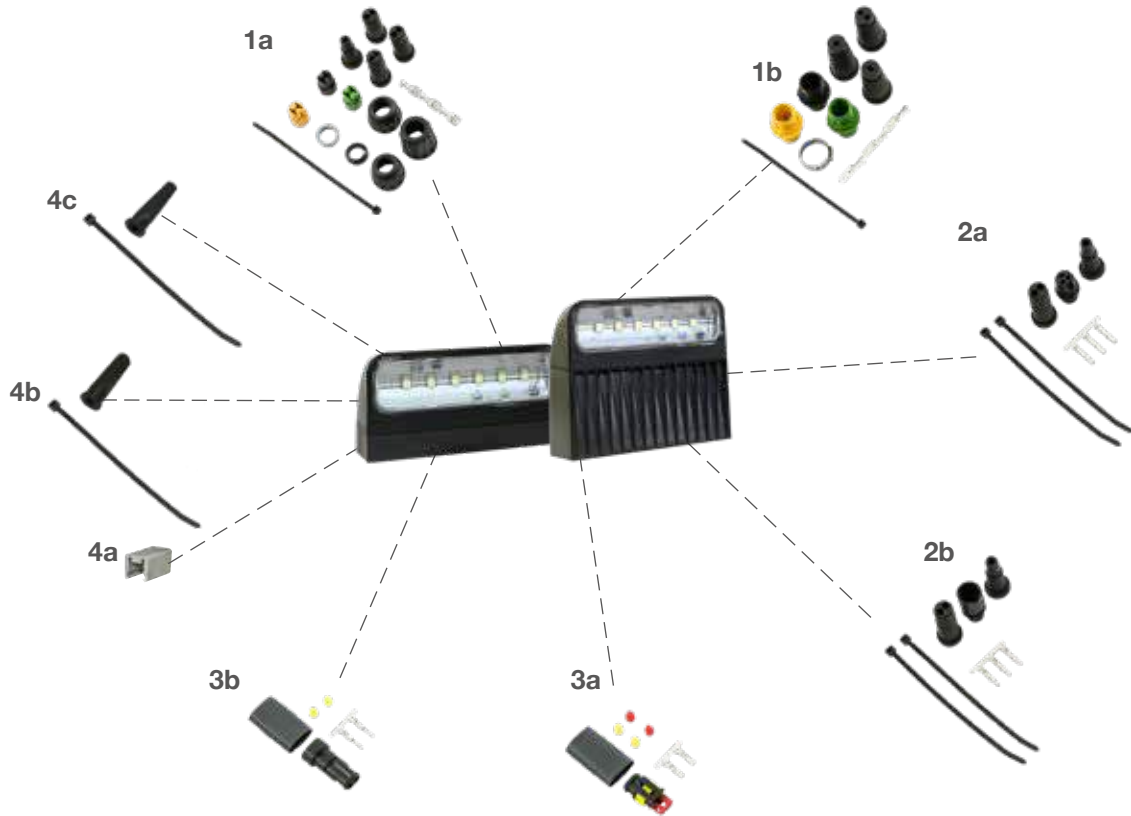

## 1 ASS1 & ASS2 Verbinder | ASS1 & ASS2 connector

- (a) 2 pol. weiblich  
2 pin female ..... 13-5626-401
- (b) 2 pol. männlich  
2 pin male ..... 13-5625-991

## 2 ASS3 Verbinder | ASS3 connector

- (a) 3 pol. weiblich  
3 pin female ..... 13-0322-281
- (b) 3 pol. männlich  
3 pin male ..... 13-0332-281

## 3 Superseal Verbinder | Superseal connector

- (a) 2 pol. weiblich  
2 pin female ..... 15-7002-044
- (b) 2 pol. männlich  
2 pin male ..... 15-7002-054

## 4 für P&R Verbinder | for P&R connector

- (a) Verschlusskappen  
caps ..... 15-5971-014
- (b) Endkappen rund  
end caps round ..... 15-5983-024
- (c) Endkappen eckig  
end caps square ..... 15-5729-014





# REGPOINT LED

ADR  
Zone 2

IP 54

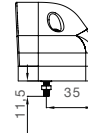
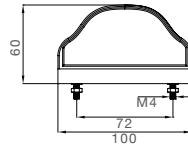
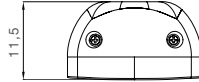

Kennzeichenlicht  
Number plate light

BEST. NR				ZUSATZ	ANSCHLUSS
PART NO				ADD ON	CONNECTOR
36-3607-004	1/-	LED	24V		2 pol. ASS2 2 pin ASS2 ♀   0,50 m
36-3607-034	1/50	LED	24V		2 pol. ASS2 2 pin ASS2 ♀   0,80 m
36-3607-014	1/30	LED	24V		2 pol. ASS2 2 pin ASS2 ♀   1,00 m
36-3607-024	1/-	LED	24V		2 pol. ASS2 2 pin ASS2 ♀   3,50 m
36-3607-074	1/-	LED	24V		3 pol. ASS3 3 pin ASS3 ♀   0,50 m
36-3607-094	1/-	LED	24V		3 pol. ASS3 3 pin ASS3 ♀   1,00 m
36-3690-004	1/-	LED	24V		2 pol. AFK plus lear 2 pin AFK plus lear 0,50 m
36-3690-034	1/-	LED	24V		2 pol. Deutsch 2 pin Deutsch ♂   0,17 m
36-3600-044	1/-	LED	24V		2 pol. Superseal 2 pin Superseal ♀   0,25 m
36-3690-014	1/-	LED	24V		2 pol. Superseal 2 pin Superseal ♂   3,50 m
36-3690-024	1/-	LED	24V		2 pol. Superseal 2 pin Superseal ♀   1,20 m
36-3690-044	1/-	LED	24V		2 pol. Superseal 2 pin Superseal ♂   0,15 m
36-3600-004	1/-	LED	24V		offenes Ende open end 0,50 m
36-3600-014	1/80	LED	24V		offenes Ende open end 1,00 m
36-3600-024	1/-	LED	24V		offenes Ende open end 3,50 m
36-3604-004	1/-	LED	24V		P&R 0,50 m
36-3604-014	1/50	LED	24V		P&R 1,00 m
36-3604-024	1/-	LED	24V		P&R 3,50 m



# REGPOINT LED

ZUBEHÖR / ACCESSORIES

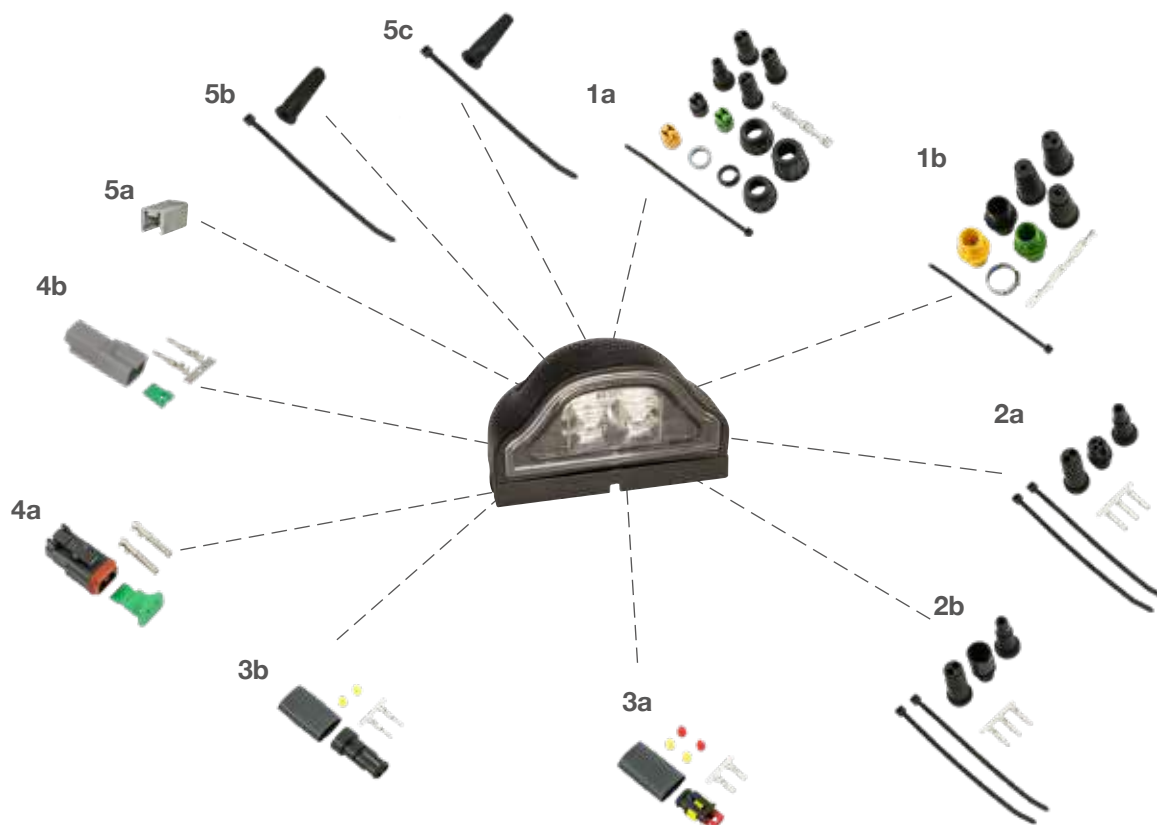

## 1 ASS1 & ASS2 Verbinder ASS1 & ASS2 connector

- (a) 2 pol. weiblich  
2 pin female ..... 13-5626-401
- (b) 2 pol. männlich  
2 pin male ..... 13-5625-991

## 2 ASS3 Verbinder | ASS3 connector

- (a) 3 pol. weiblich  
3 pin female ..... 13-0322-281
- (b) 3 pol. männlich  
3 pin male ..... 13-0332-281

## 3 Superseal Verbinder | Superseal connector

- (a) 2 pol. weiblich  
2 pin female ..... 15-7002-044
- (b) 2 pol. männlich  
2 pin male ..... 15-7002-054

## 4 Deutsch Verbinder | Deutsch connector

- (a) 2 pol. weiblich  
2 pin female ..... 15-7002-135
- (b) 2 pol. männlich  
2 pin male ..... 15-7002-125

## 5 für P&R Verbinder | for P&R connector

- (a) Verschlusskappen  
caps ..... 15-5971-014
- (b) Endkappen rund  
end caps round ..... 15-5983-024
- (c) Endkappen eckig  
end caps square ..... 15-5729-014





# REGPOINT





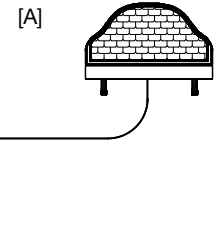
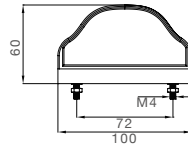
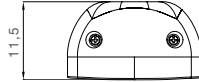











































ADR  
Zone 2

IP 54



 Kennzeichenlicht  
Number plate light

Kennzeichen-  
leuchte  
Number Plate  
Lamp

BEST. NR				ZUSATZ	ANSCHLUSS	
PART NO				ADD ON	CONNECTOR	
36-3002-014	1/-		24V		offenes Ende open end	1,00 m 
36-3003-014	1/-		24V		offenes Ende open end	0,30 m 
36-3004-014	1/50		24V	M4x16	P&R 	0,50 m 
36-3004-024	1/-		24V		P&R 	1,00 m 
36-3004-034	1/50		24V		P&R 	1,50 m 
36-3004-044	1/-		24V		P&R 	2,00 m 
36-3004-054	1/50		24V		P&R 	3,50 m 
36-3007-284	1/50		24V		2 pol. ASS2 2 pin ASS2 	0,55 m 
36-3007-254	1/50		24V		2 pol. ASS2 2 pin ASS2 	1,20 m 
36-3007-084	1/-		24V		2 pol. ASS2 2 pin ASS2 	3,50 m 
36-3007-394	1/-		24V	M4x16	3 pol. ASS3 3 pin ASS3 	0,50 m 
36-3007-464	1/-		24V	M4x35	3 pol. ASS3 3 pin ASS3 	0,50 m 
36-3007-264	1/-		24V	[A]	2 pol. ASS2 2 pin ASS2  2 pol. ASS2 2 pin ASS2 	1,02 m  0,2 m 
36-3000-134	1/-		24V		2 pol. Superseal 2 pin Superseal 	1,20 m 
36-3007-574	1/60		24V		2 pol. ASS2 2 pin ASS2 	0,70 m 



# REGPOINT

ZUBEHÖR / ACCESSORIES

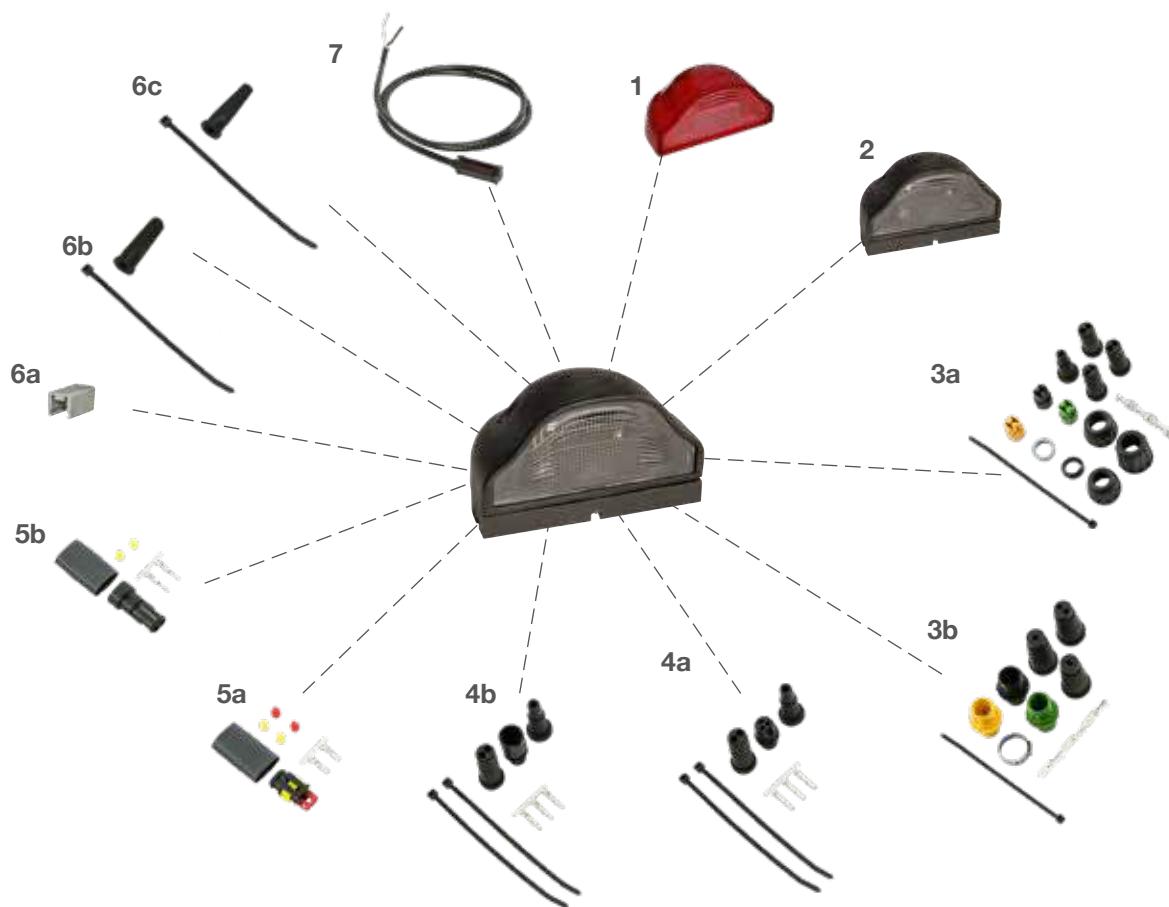

**1** Lichtscheibe | lens  
transparent rot  
transparent red ..... 18-8630-104

**2** Ersatzteilleuchte |  
spare part lamp  
weiß mit Schrauben  
white with screws ..... 26-3000-004

**3** ASS1 & ASS2 Verbinder |  
ASS1 & ASS2 connector  
(a) 2 pol. weiblich  
2 pin female ..... 13-5626-401   
(b) 2 pol. männlich  
2 pin male ..... 13-5625-991

**4** ASS3 Verbinder | ASS3 connector  
(a) 3 pol. weiblich  
3 pin female ..... 13-0322-281   
(b) 3 pol. männlich  
3 pin male ..... 13-0332-281

**5** Superseal Verbinder | Superseal connector  
(a) 2 pol. weiblich  
2 pin female ..... 15-7002-044   
(b) 2 pol. männlich  
2 pin male ..... 15-7002-054

**6** für P&R Verbinder |  
for P&R connector  
(a) Verschlusskappen  
caps ..... 15-5971-014   
(b) Endkappen rund  
end caps round ..... 15-5983-024   
(c) Endkappen eckig  
end caps square ..... 15-5729-014

**7** Zuleitung P&R | front connection P&R  
0,5 m ..... 68-5000-574   
1,5 m ..... 68-5000-604   
2,0 m ..... 68-5000-624   
5,0 m ..... 68-5000-634





REGPOINT rot  
red

ADR  
Zone 2

IP 54

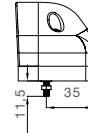
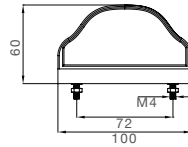
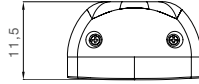

Kennzeichenlicht  
Number plate light

BEST. NR PART NO				ZUSATZ ADD ON	ANSCHLUSS CONNECTOR
36-3004-184	1/-		24V		P&R  0,50 m
36-3004-084	1/-		24V		P&R  1,50 m



REGPOINT rot  
red

ZUBEHÖR / ACCESSORIES

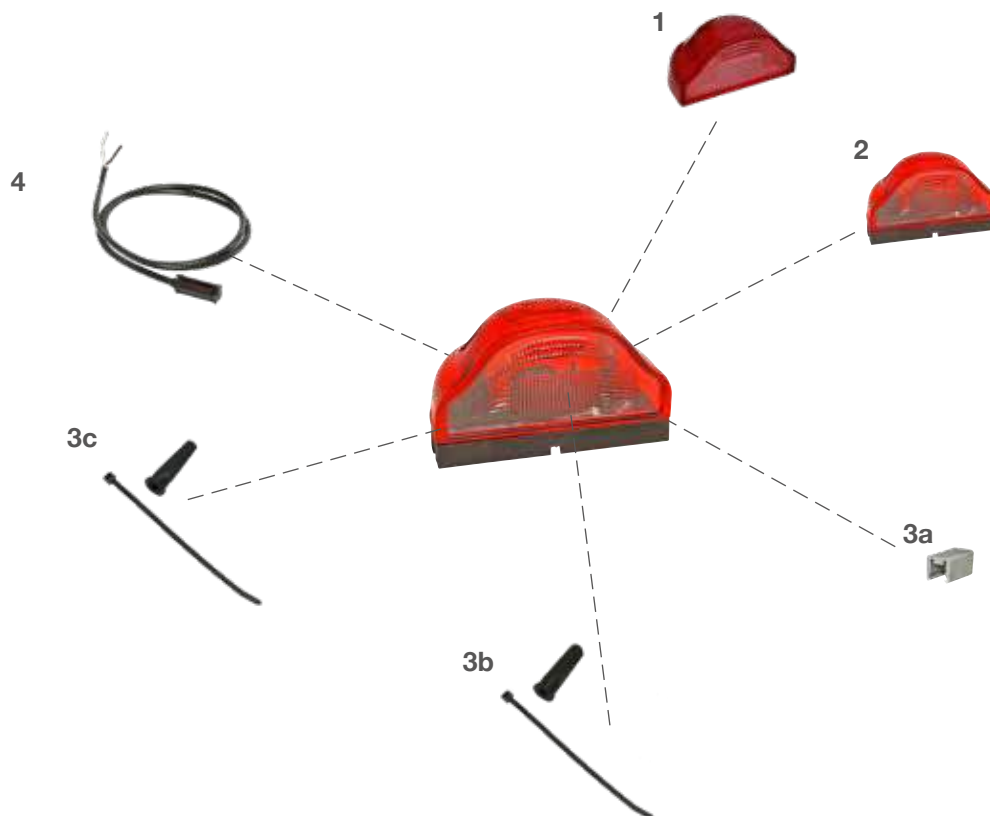

**1** Lichtscheibe | lens  
transparent rot  
transparent red ..... 18-8630-104

**2** Ersatzteileuchte |  
spare part lamp  
rot mit Schrauben  
red with screws..... 26-3010-004

**3** für P&R Verbinder |  
for P&R connector  
(a) Verschlusskappen  
caps..... 15-5971-014   
(b) Endkappen rund  
end caps round..... 15-5983-024   
(c) Endkappen eckig  
end caps square..... 15-5729-014

**4** Zuleitung P&R | front connection P&R  
0,5 m..... 68-5000-574   
1,5 m..... 68-5000-604   
2,0 m..... 68-5000-624   
5,0 m..... 68-5000-634





REGPOINT klein  
small

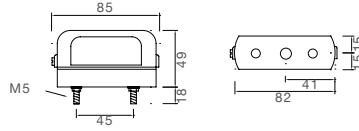

Kennzeichenlicht  
Number plate light

BEST. NR				ZUSATZ ADD ON	ANSCHLUSS CONNECTOR
26-1200-004	1/-	-			Tülleneingang grommet
36-1204-034	1/15		24V		P&R  0,50 m
36-1207-004	1/-		24V		2 pol. ASS2 2 pin ASS2  1,50 m







REGPOINT klein  
small

ZUBEHÖR / ACCESSORIES

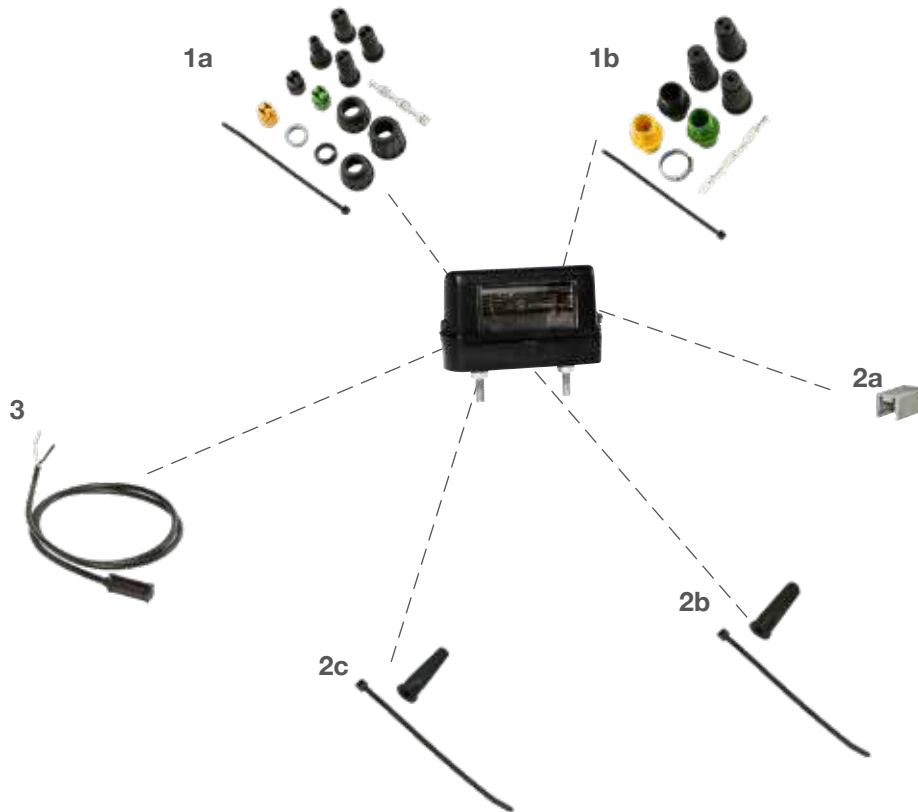

**1** ASS1 & ASS2 Verbinder |  
ASS1 & ASS2 connector

- (a) 2 pol. weiblich  
2 pin female ..... 13-5626-401
- (b) 2 pol. männlich  
2 pin male ..... 13-5625-991

**2** für P&R Verbinder |  
for P&R connector

- (a) Verschlusskappen  
caps ..... 15-5971-014
- (b) Endkappen rund  
end caps round ..... 15-5983-024
- (c) Endkappen eckig  
end caps square ..... 15-5729-014

**3** Zuleitung P&R | front connection P&R  
0,5 m ..... 68-5000-574



# FRYSPÖCK<sup>®</sup>

## SYSTEMS



## BREMSLEUCHE

Bremsleuchten sind Signalleuchten und somit eines der wichtigsten Kommunikationsmittel im Straßenverkehr. Unsere Bremsleuchten sind wahlweise als Einbau- oder Aufbauversionen erhältlich. Sie eignen sich ideal zum Austausch von bestehenden Bremsleuchten, zur Aufrüstung als LED oder auch zum ergänzenden Anbau.

## STOP LAMP

Stop lamps are signal lamps and thus one of the most important forms of communication in road traffic. Our stop lamps are available either as integrated or as mounted versions. They are ideal for replacing existing stop lamps, as LED retrofits or also for supplementary mounting.





## DRITTE BREMSLEUCHE / THIRD STOP LAMP

ADR Zone 2 IP6K9K

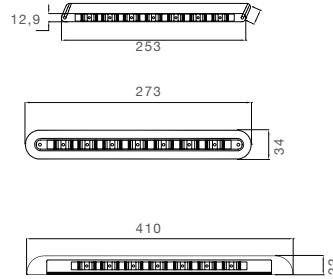



BEST. NR					ZUSATZ	ANSCHLUSS	
PART NO					ADD ON	CONNECTOR	
31-8900-024	1/-	LED	24V		Einbauversion lamp built in	offenes Ende open end	2,00 m
31-8900-044	1/40	LED	24V		Einbauversion lamp built-in	offenes Ende open end	6,00 m
31-8907-004	1/-	LED	24V		Einbauversion lamp built-in	2 pol. ASS2 2 pin ASS2	2,00 m
31-8907-014	1/-	LED	24V		inkl. Rahmen incl. housing	2 pol. ASS2 2 pin ASS2	2,00 m
31-8910-014	1/-	LED	24V		inkl. Rahmen incl. housing	offenes Ende open end	0,50 m
31-8910-024	1/-	LED	24V		inkl. Rahmen incl. housing	offenes Ende open end	2,00 m
31-9000-054	1/-	LED	24V		Aufbauversion lamp surface mount	offenes Ende open end	2,00 m
31-9007-014	1/10	LED	24V		Aufbauversion lamp surface mount	2 pol. ASS2 2 pin ASS2	2,00 m

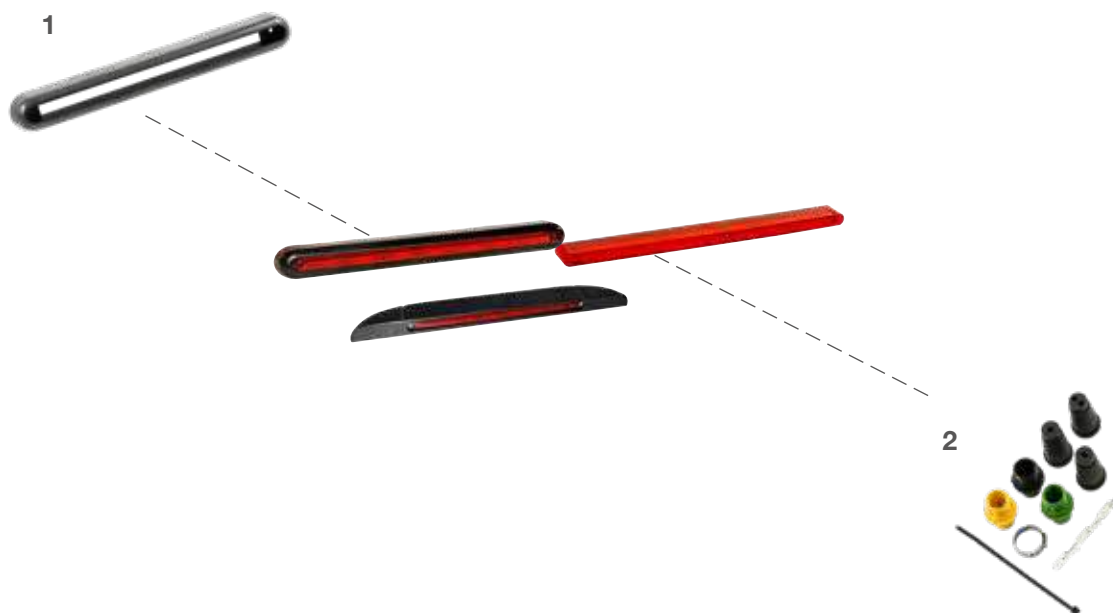

## DRITTE BREMSLEUCHE THIRD STOP LAMP

ZUBEHÖR / ACCESSORIES



**1** Rahmen | housing  
..... 15-5203-004 

**2** ASS1 & ASS2 Verbinder |  
ASS1 & ASS2 connector  
(a) 2 pol. weiblich  
2 pin female ..... 13-5626-401   
(b) 2 pol. männlich  
2 pin male ..... 13-5625-991 

FAUPÖCK®

SPARE PARTS



## **RÜCKFAHRLEUCHE ARBEITSSCHEINWERFER**

Unsere Rückfahr- und Arbeitsscheinwerfer werden unter extremen Bedingungen für maximale Beständigkeit entwickelt. Langlebigkeit, eine hohe Lichtleistung und eine geringe Stromaufnahme sorgen dafür, dass die Arbeitsumgebung auch bei schlechten Lichtverhältnissen und jedem Wetter optimal ausgeleuchtet ist.

## **REVERSE LAMP WORKING LAMP**

Our reverse lamps and working lamps have been developed under extreme conditions for maximum durability. Longevity, high illumination output and low power consumption ensure that the working environment is optimally lightened even in low light conditions and in all weather conditions.





## WORKPOINT II 1000

ADR Zone 2 IP 6K9K



Produktinformation  
Product information

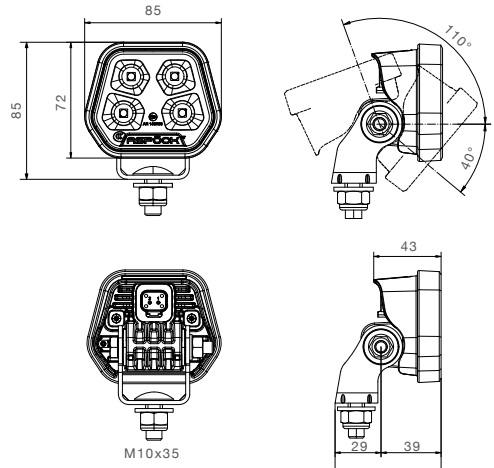

	Rückfahrlicht Reverse light		Arbeitscheinwerfer Working light
--	--------------------------------	--	-------------------------------------

BEST. NR PART NO				ZUSATZ ADD ON	ANSCHLUSS CONNECTOR
28-8524-011	1/24	LED	12V/24V	1000 LUMEN 10W FLOOD	-40°C - +50°C 2 pol. Deutsch ♂ 2 pin Deutsch
38-8524-011	1/24	LED	12V/24V	1000 LUMEN 10W FLOOD	offenes Ende open end 1,50 m
38-8524-061	1/24	LED	12V/24V	1000 LUMEN 10W FLOOD	-40°C - +50°C 2 pol. ASS2 ♀ 2 pin ASS2 1,50 m

Rückfahrleuchte  
Arbeitscheinwerfer  
Reverse Lamp  
Working Lamp





# WORKPOINT II 1500

ADR Zone 2 IP 6K9K



Produktinformation  
Product information

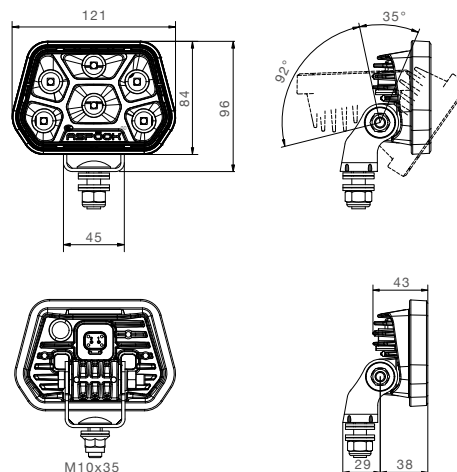

Rückfahrlicht  
Reverse light



Arbeitsscheinwerfer  
Working light

BEST. NR				ZUSATZ	ANSCHLUSS	
PART NO				ADD ON	CONNECTOR	
28-8524-001	1/24	LED	12V/24V	1500 LUMEN 14W FLOOD	-40°C - +50°C	2 pol. Deutsch 2 pin Deutsch ♂
38-8524-001	1/24	LED	12V/24V	1500 LUMEN 14W FLOOD	-40°C - +50°C	offenes Ende open end 1,50 m
38-8524-071	1/24	LED	12V/24V	1500 LUMEN 14W FLOOD	-40°C - +50°C	offenes Ende open end 7,00 m
38-8524-051	1/24	LED	12V/24V	1500 LUMEN 14W FLOOD	-40°C - +50°C	2 pol. ASS2 2 pin ASS2 ♀  1,50 m
38-8524-081	1/24	LED	12V/24V	1500 LUMEN 14W FLOOD	-40°C - +50°C	2 pol. ASS2 2 pin ASS2 ♀  7,00 m

Rückfahrleuchte  
Arbeitsscheinwerfer  
Reverse Lamp  
Working Lamp



# WORKPOINT II 3000







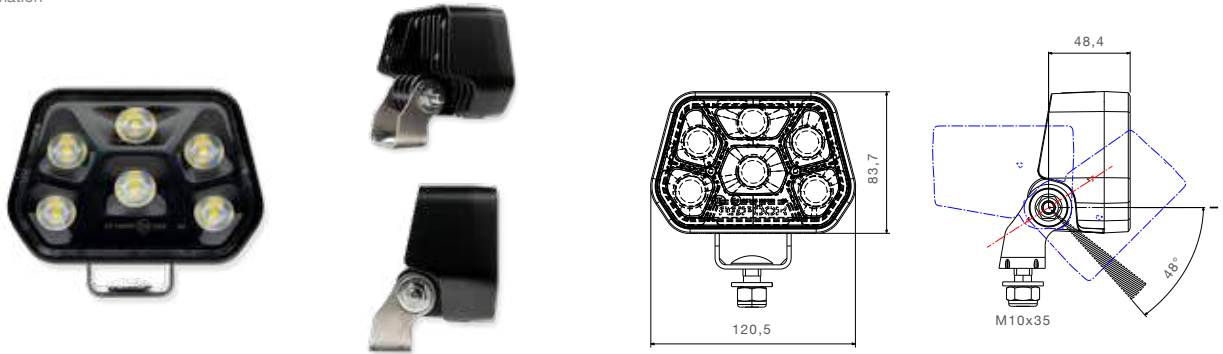



ADR Zone 2 IP 6K9K



Produktinformation  
Product information



 Rückfahrlicht Reverse light	 Arbeitsscheinwerfer Working light
--	--

BEST. NR				ZUSATZ	ANSCHLUSS	
PART NO				ADD ON	CONNECTOR	
28-8524-041	1/16	LED	12V/24V	3000 LUMEN 35W SPOT	60° Abstrahlwinkel radiation angle -40°C - +50°C 2 pol. Deutsch 2 pin Deutsch	  
38-8524-041	1/16	LED	12V/24V	3000 LUMEN 35W SPOT	60° Abstrahlwinkel radiation angle -40°C - +50°C offenes Ende open end	1,50 m 
28-8524-031	1/16	LED	12V/24V	3000 LUMEN 35W FLOOD	20° Abstrahlwinkel radiation angle -40°C - +50°C 2 pol. Deutsch 2 pin Deutsch	  
38-8524-031	1/16	LED	12V/24V	3000 LUMEN 35W FLOOD	20° Abstrahlwinkel radiation angle -40°C - +50°C offenes Ende open end	1,50 m 

Rückfahrlicht  
Arbeitsscheinwerfer  
Reverse Lamp  
Working Lamp





WORKPOINT II 1000 / 1500 / 3000



ZUBEHÖR / ACCESSORIES



**1** ASS1 & ASS2 Verbinder | ASS1 & ASS2 connector

- (a) 2 pol. weiblich  
2 pin female ..... 13-5626-401 
- (b) 2 pol. männlich  
2 pin male ..... 13-5625-991 



**2** ASS3 Verbinder | ASS3 connector

- (a) 2 pol. weiblich  
2 pin female ..... 13-0322-281 
- (b) 2 pol. männlich  
2 pin male ..... 13-0332-281 

**3** Superseal Verbinder | Superseal connector

- (a) 2 pol. weiblich  
2 pin female ..... 15-7002-044 
- (b) 2 pol. männlich  
2 pin male ..... 15-7002-054 

**4** Deutsch Verbinder | Deutsch connector

- (a) 2 pol. weiblich  
2 pin female ..... 15-7002-135 
- (b) 2 pol. männlich  
2 pin male ..... 15-7002-125 



WORKPOINT II 1000 / 1500 / 3000







ZUBEHÖR / ACCESSORIES



**5 Halterung | bracket**

- (a) Omega Halterung  
omega bracket ..... 14-4302-224 

**6 Deutsch Verlängerungskabel |  
Deutsch extension cable**

- (a) Verlängerung DT Version 3,00 m  
extension for DT version 3,00 m  
..... 69-0236-014 
- (b) Verlängerung DT Version 5,00 m  
extension for DT version 5,00 m  
..... 69-0236-004 
- (c) Verlängerung DT Version 6,50 m  
extension for DT version 6,50 m  
..... 69-0236-054 
- (d) Verlängerung DT Version 8,00 m  
extension for DT version 8,00 m  
..... 69-0236-024 
- (e) Verlängerung DT Version 10,00 m  
extension for DT version 10,00 m  
..... 69-0236-034 
- (f) Verlängerung DT Version 12,00 m  
extension for DT version 12,00 m  
..... 69-0236-044 



# FLATPOINT IV

## Position lamp | Positionsleuchte

- >> LED-Positionslicht mit integriertem Glowing Body | *LED position light with integrated Glowing Body*
- >> In der höchsten Schutzklasse IP6K9K geprüft | *Tested in the highest protection class IP 6K9K*



# WORKPOINT LED 1500

ADR Zone 2 IP6K9K



Produktinformation  
Product information

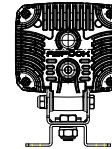
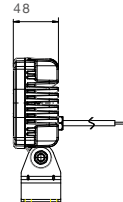
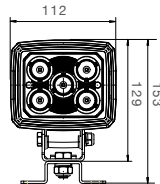

Rückfahrlicht Reverse light	Arbeitsscheinwerfer Working light
--------------------------------	--------------------------------------

BEST. NR				ZUSATZ	ANSCHLUSS
PART NO				ADD ON	CONNECTOR
38-8220-001	1/12	<b>LED</b>	12V 24V	<b>1500 LUMEN</b> <b>25W</b> -40°C bis +80°C	offenes Ende open end <span style="float: right;">1,50 m </span>



# WORKPOINT LED 1500

## ZUBEHÖR / ACCESSORIES

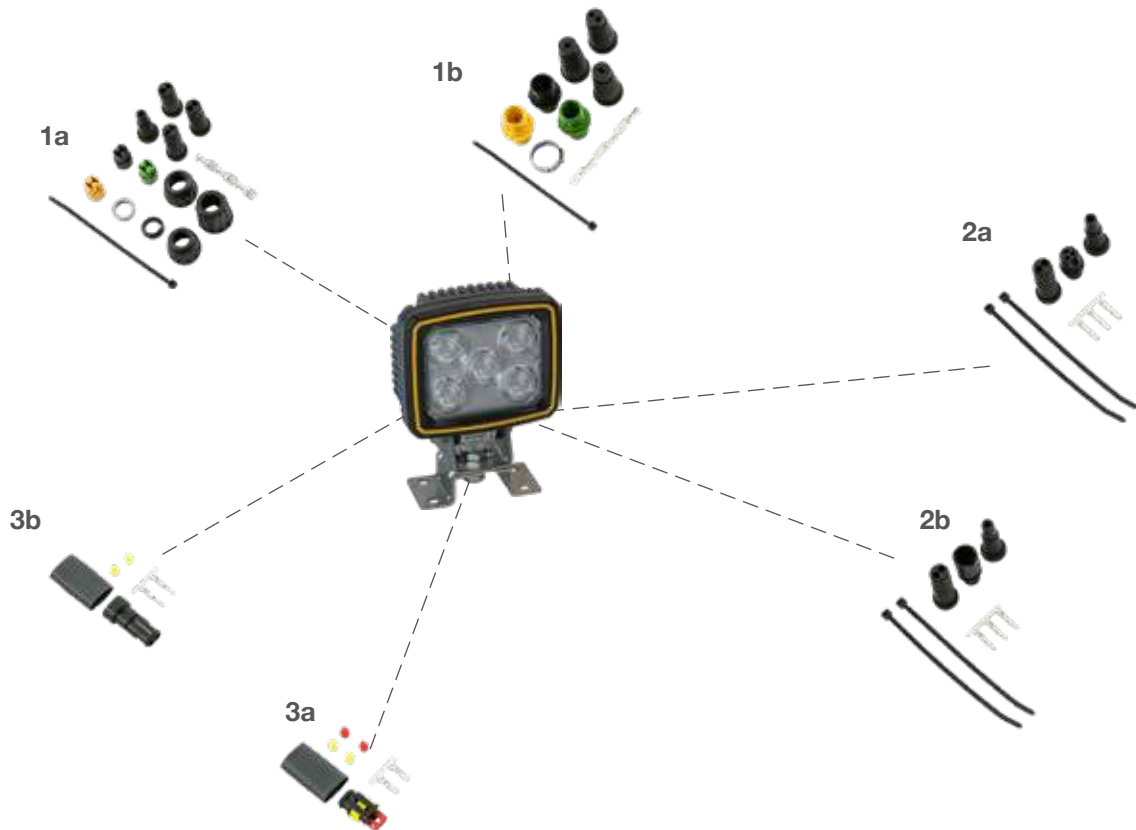

### 1 ASS1 & ASS2 Verbinder | ASS1 & ASS2 connector

- (a) 2 pol. weiblich  
2 pin female ..... 13-5626-401
- (b) 2 pol. männlich  
2 pin male ..... 13-5625-991

### 2 ASS3 Verbinder | ASS3 connector

- (a) 3 pol. weiblich  
3 pin female ..... 13-0322-281
- (b) 3 pol. männlich  
3 pin male ..... 13-0332-281

### 3 Superseal Verbinder | Superseal connector

- (a) 2 pol. weiblich  
2 pin female ..... 15-7002-044
- (b) 2 pol. männlich  
2 pin male ..... 15-7002-054





# WORKPOINT LED 1500

ZUBEHÖR / ACCESSORIES

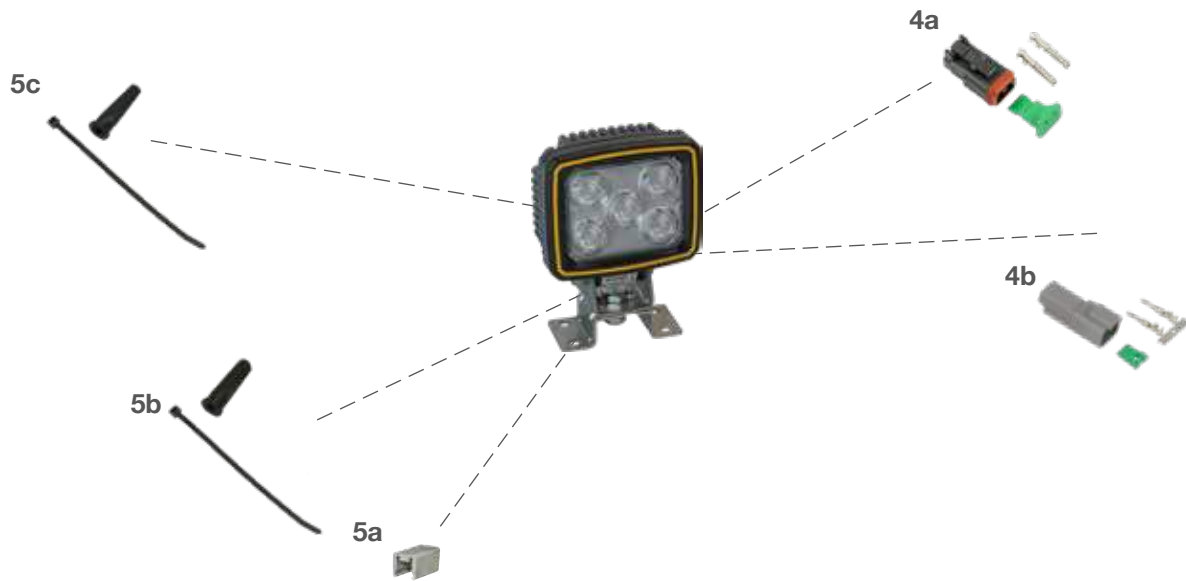

## 4 Deutsch Verbinder | Deutsch connector

- (a) 2 pol. weiblich  
2 pin female ..... 15-7002-135
- (b) 2 pol. männlich  
2 pin male ..... 15-7002-125

## 5 für P&R Verbinder | for P&R connector

- (a) Verschlusskappen  
caps ..... 15-5971-014
- (b) Endkappen rund  
end caps round ..... 15-5983-024
- (c) Endkappen eckig  
end caps square ..... 15-5729-014



THE ART OF LIGHTS



# RADDC 1.0

Rückraumüberwachung für Lkw und Anhänger  
Rear area monitoring for trucks & trailers

[aspoeck.com](http://aspoeck.com)



# RÜCKFAHRSCHEINWERFER LED / REVERSE LAMP LED

ADR  
Zone 2

IP56K

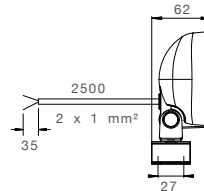
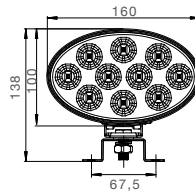

Rückfahrlicht  
Reverse light

BEST. NR				ZUSATZ	ANSCHLUSS
PART NO				ADD ON	CONNECTOR
38-8200-001	1/-	LED	12V/ 24V	200 LUMEN -40°C - +80°C	offenes Ende open end 2,50 m
38-8207-001	1/-	LED	12V/ 24V	200 LUMEN -40°C - +80°C	2 pol. ASS2 2 pin ASS2 2,50 m
38-8207-011	1/20	LED	12V/ 24V	200 LUMEN -40°C - +80°C	2 pol. Superseal 2 pin Superseal 2,50 m



# RÜCKFAHRSCHEINWERFER LED / REVERSE LAMP LED

ZUBEHÖR /  
ACCESSORIES



## 1 ASS1 & ASS2 Verbinder | ASS1 & ASS2 connector

- (a) 2 pol. weiblich  
2 pin female ..... 13-5626-401
- (b) 2 pol. männlich  
2 pin male ..... 13-5625-991

## 2 Superseal Verbinder | Superseal connector

- (a) 2 pol. weiblich  
2 pin female ..... 15-7002-044
- (b) 2 pol. männlich  
2 pin male ..... 15-7002-054









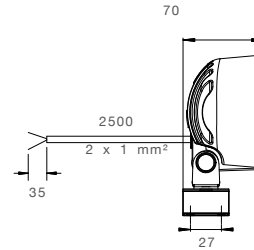
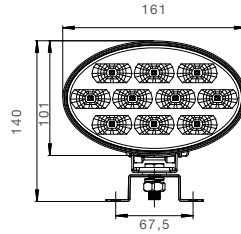













# WORKPOINT LED 800

ADR  
Zone 2

IP56K



 Arbeitsscheinwerfer  
Working light

BEST. NR				ZUSATZ	ANSCHLUSS
PART NO				ADD ON	CONNECTOR
39-6800-011	1/-		12V/ 24V	 	offenes Ende open end 2,50 m 
39-6801-001	1/-		12V/ 24V	 	2 pol. Superseal    2 pin Superseal
39-6807-001	1/-		12V/ 24V	 	2 pol. ASS2    2 pin ASS2 2,50 m 

Rückfahrleuchte  
 Arbeitsscheinwerfer  
 Reverse Lamp  
 Working Lamp



# WORKPOINT LED 800

## ZUBEHÖR / ACCESSORIES

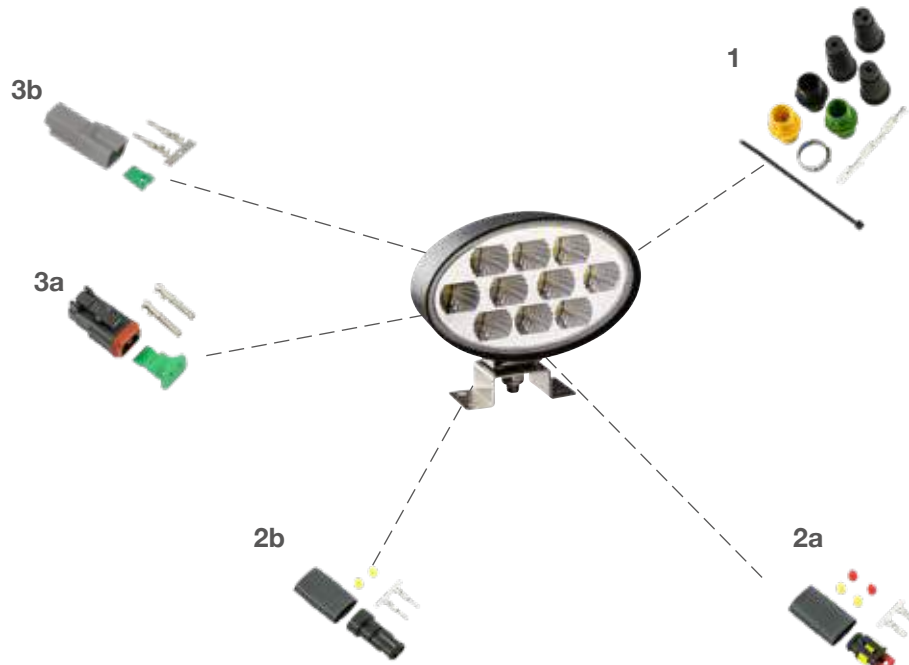

### 1 ASS1 & ASS2 Verbinder | ASS1 & ASS2 connector

- (a) 2 pol. weiblich  
2 pin female ..... 13-5626-401
- (b) 2 pol. männlich  
2 pin male ..... 13-5625-991

### 2 Superseal Verbinder | Superseal connector

- (a) 2 pol. weiblich  
2 pin female ..... 15-7002-044
- (b) 2 pol. männlich  
2 pin male ..... 15-7002-054

### 3 Deutsch Verbinder | Deutsch connector

- (a) 2 pol. weiblich  
2 pin female ..... 15-7002-135
- (b) 2 pol. männlich  
2 pin male ..... 15-7002-125











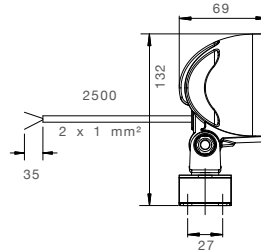
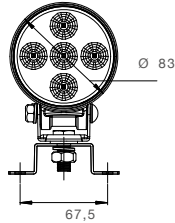

























# WORKPOINT LED 650

ADR  
Zone 2

IP56K



 Arbeitsscheinwerfer  
Working light

BEST. NR				ZUSATZ	ANSCHLUSS
PART NO				ADD ON	CONNECTOR
39-6400-011	1/20		12V/ 24V	 	offenes Ende open end 2,50 m 
39-6400-031	1/-		12V/ 24V	 	2 pol. Superseal 2 pin Superseal   2,50 m 
39-6407-001	1/20		12V/ 24V	 	2 pol. ASS2 2 pin ASS2   2,50 m 
39-6407-011	1/-		12V/ 24V	 	2 pol. ASS2 2 pin ASS2   1,50 m 
39-6400-041	1/20		12V/ 24V	 	2 pol. Deutsch 2 pin Deutsch   0,30 m 



# WORKPOINT LED 650

## ZUBEHÖR / ACCESSORIES

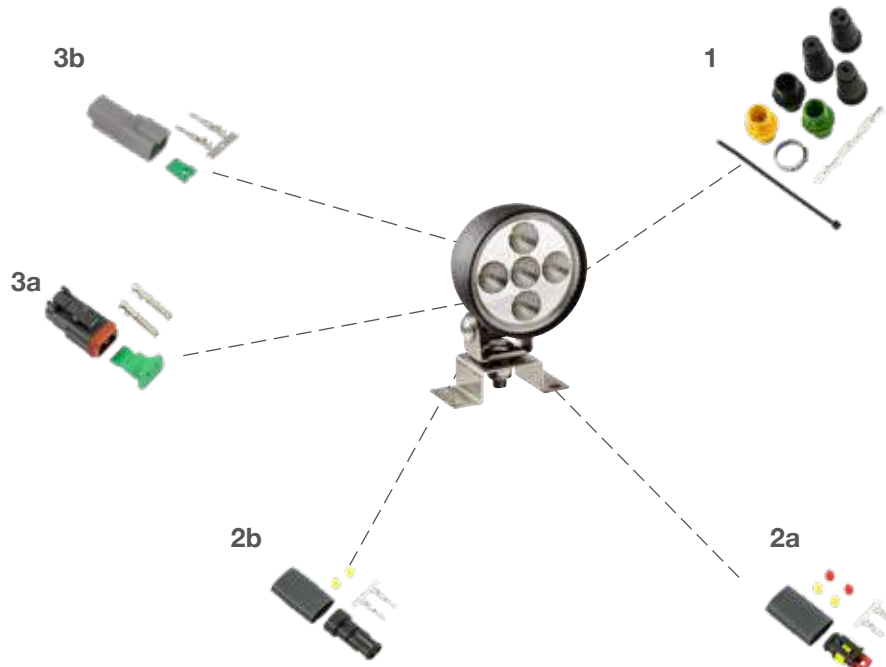

### 1 ASS1 & ASS2 Verbinder | ASS1 & ASS2 connector

- (a) 2 pol. weiblich  
2 pin female ..... 13-5626-401
- (b) 2 pol. männlich  
2 pin male ..... 13-5625-991

### 2 Superseal Verbinder | Superseal connector

- (a) 2 pol. weiblich  
2 pin female ..... 15-7002-044
- (b) 2 pol. männlich  
2 pin male ..... 15-7002-054

### 3 Deutsch Verbinder | Deutsch connector

- (a) 2 pol. weiblich  
2 pin female ..... 15-7002-135
- (b) 2 pol. männlich  
2 pin male ..... 15-7002-125



# RÜCKFAHRSCHEINWERFER / REVERSE LAMP ARBEITSSCHEINWERFER / WORKING LAMP

ADR Zone 2 IP 5K4K

21W

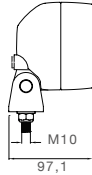
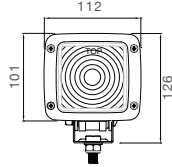

70W

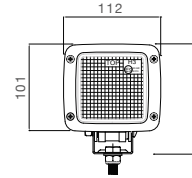

Rückfahrlicht  
Reverse light



Arbeitsscheinwerfer  
Working light

BEST. NR					ZUSATZ	ANSCHLUSS	
PART NO					ADD ON	CONNECTOR	
28-9100-001	1/-		24V		<b>70W</b>	Tülleneingang grommet	
38-9000-001	1/10		24V		<b>21W</b>	offenes Ende open end	2,50 m
38-9100-001	1/-		24V		<b>70W</b>	offenes Ende open end	2,50 m
38-9007-011	1/-		24V		<b>21W</b>	2 pol. ASS2 2 pin ASS2	2,50 m
38-9107-011	1/-		24V		<b>70W</b>	2 pol. ASS2 2 pin ASS2	2,50 m
38-9010-001	1/25		24V		<b>21W</b>	2 pol. Superseal 2 pin AMP	0,25 m
38-9100-081	1/10		24V		<b>70W</b>	2 pol. Deutsch 2 pin Deutsch	2,25 m

Rückfahrlicht  
Arbeitsscheinwerfer  
Reverse Lamp  
Working Lamp





# RÜCKFAHRSCHEINWERFER / REVERSE LAMP ARBEITSSCHEINWERFER / WORKING LAMP

ZUBEHÖR /  
ACCESSORIES



## 1 ASS1 & ASS2 Verbinder | ASS1 & ASS2 connector

- (a) 2 pol. weiblich  
2 pin female ..... 13-5626-401
- (b) 2 pol. männlich  
2 pin male ..... 13-5625-991

## 2 Superseal Verbinder | Superseal connector

- (a) 2 pol. weiblich  
2 pin female ..... 15-7002-044
- (b) 2 pol. männlich  
2 pin male ..... 15-7002-054

## 3 Deutsch Verbinder | Deutsch connector

- (a) 2 pol. weiblich  
2 pin female ..... 15-7002-135
- (b) 2 pol. männlich  
2 pin male ..... 15-7002-125

## 4 Glühlampe | bulb

- 24V 70W H3..... 16-6456-001



# FAPÖÖKX<sup>®</sup>

## S T E M S



## INNENLEUCHE

Auch Fahrzeug- oder Anhängerinnenräume sind Bereiche, in denen gearbeitet wird und sicherheitsgebende Lichtquellen benötigen. Unser kompaktes Sortiment an Innenleuchten kommt hier erfolgreich zum Einsatz. In LED-Technologie ausgeführt, unterscheiden sie sich in Design und Leuchtkraft.

## INTERIOR LAMP

Vehicle or trailer interiors are also areas where work is done and require safety-giving light sources. Our compact range of interior lamps is successfully used here. Designed in LED technology, they differ in design and brightness.





INPOINT III LED lang, kurz,  
long, short



Produktinformation  
Product information

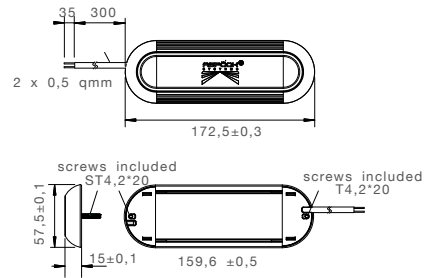
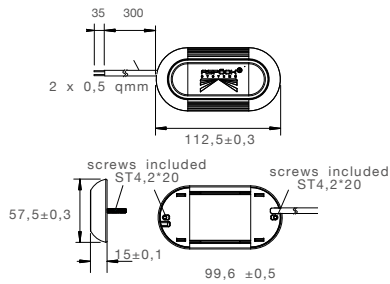

Innenlicht  
Interior Light

BEST. NR					ZUSATZ				ANSCHLUSS	
PART NO					ADD ON				CONNECTOR	
39-8900-001	1/60		12V/ 24V		lang long	-40°C - +80°C 6000 +/- 500k			offenes Ende open end	0,30 m
39-8900-051	1/80		12V/ 24V		lang, mit Bewegungssensor long, with motion sensor	-40°C - +80°C 6000 +/- 500k			offenes Ende open end	0,30 m
39-8900-101	1/-		12V/ 24V		lang, mit Schalter long, with switch	-40°C - +80°C 6000 +/- 500k			offenes Ende open end	0,30 m
39-8900-151	1/100		12V/ 24V		kurz short	-40°C - +80°C 6000 +/- 500k			offenes Ende open end	0,30 m
39-8900-201	1/100		12V/ 24V		kurz, mit Bewegungssensor short, with motion sensor	-40°C - +80°C 6000 +/- 500k			offenes Ende open end	0,30 m
39-8900-251	1/-		12V/ 24V		kurz, mit Schalter short, with switch	-40°C - +80°C 6000 +/- 500k			offenes Ende open end	0,30 m

ZUBEHÖR / ACCESSORIES

- 1** selbstklebende Gummiunterlage |  
selfadhesive rubber  
..... 15-5020-824





# INPOINT III LED rund round

ADR  
Zone 2



Produktinformation  
Product information

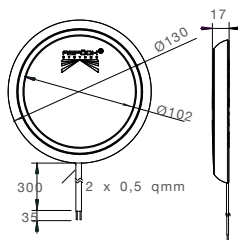

Innenlicht  
Interior Light

BEST. NR					ZUSATZ			ANSCHLUSS			
PART NO					ADD ON			CONNECTOR			
39-8900-301	1/-	<b>LED</b>	12V/ 24V		rund round	-40°C - +80°C 6000 +/- 500k	<b>IP6K9K</b>	<b>2200 LUMEN</b>	offenes Ende open end	0,30 m	
39-8900-351	1/60	<b>LED</b>	12V/ 24V		rund, mit Bewegungssensor round, with motion sensor	-40°C - +80°C 6000 +/- 500k	<b>IP67</b>	<b>2200 LUMEN</b>	offenes Ende open end	0,30 m	
39-8900-401	1/-	<b>LED</b>	12V/ 24V		rund, mit Schalter round, with switch	-40°C - +80°C 6000 +/- 500k	<b>IP6K9K</b>	<b>2200 LUMEN</b>	offenes Ende open end	0,30 m	



# INNENLEUCHE LED RUND INTERIOR LAMP LED ROUND

IP 69

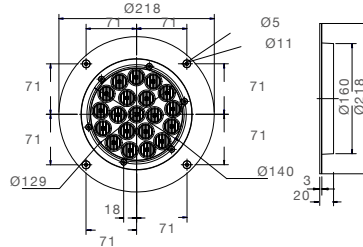
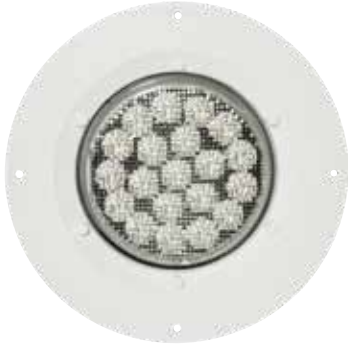

BEST. NR PART NO				ZUSATZ ADD ON	ANSCHLUSS CONNECTOR
29-8410-101	1/20	LED	12V 24V	480 LUMEN	offenes Ende open end 2 x 0,20 m
39-8404-001	1/20	LED	12V 24V	140 LUMEN	P&R  0,25 m
39-8409-001	1/-	LED	12V 24V	140 LUMEN	offenes Ende open end 2 x 0,20 m

## ZUBEHÖR / ACCESSORIES

### 1 für P&R Verbinder | for P&R connector

- (a) Verschlusskappen  
caps..... 15-5971-014
- (b) Endkappen rund  
end caps round..... 15-5983-024
- (c) Endkappen eckig  
end caps square..... 15-5729-014

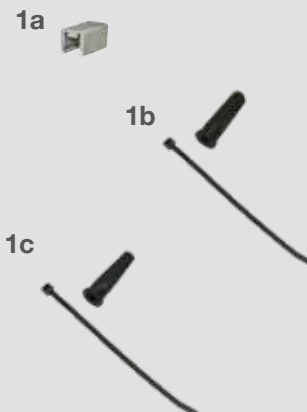



# INNENLEUCHE LED INTERIOR LAMP LED

ZUBEHÖR / ACCESSORIES

ADR Zone 2 IP 6K9K

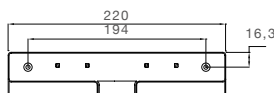

BEST. NR PART NO				ZUSATZ ADD ON	ANSCHLUSS CONNECTOR	
39-8700-011	-/-	LED	24V		offenes Ende open end	1,50 m
39-8704-001	-/-	LED	24V		P&R	0,25 m
39-8704-011	1/80	LED	24V		P&R	1,50 m
39-8707-001	-/-	LED	24V		3 pol. ASS3 3 pin ASS3	1,50 m

## ZUBEHÖR / ACCESSORIES

- 1 ASS3 Verbinder | ASS3 connector**
  - (a) 3 pol. weiblich  
3 pin female ..... 13-0322-281
  - (b) 3 pol. männlich  
3 pin male ..... 13-0332-281
- 2 für P&R Verbinder | for P&R connector**
  - (a) Verschlusskappen  
caps ..... 15-5971-014
  - (b) Endkappen rund  
end caps round ..... 15-5983-024
  - (c) Endkappen eckig  
end caps square ..... 15-5729-014

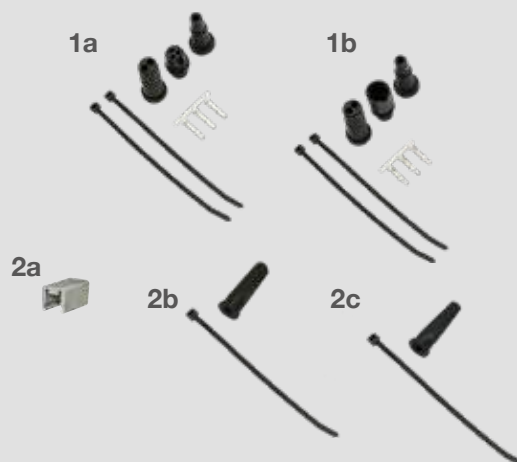



# TUBEPOINT LED

ADR Zone 2 IP6K9K



Produktinformation  
Product information



Abmessung Endkappe  
Dimension endcap

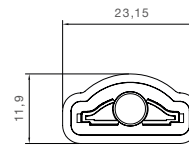

Abmessung Lichtscheibe  
Dimension Lens

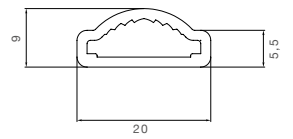

Innenlicht  
Interior Light

BEST. NR				ZUSATZ				ANSCHLUSS			
PART NO				ADD ON				CONNECTOR			
21-8004-011	1/-	<b>LED</b>	24V	450mm	-20°C bis +50°C	5700k	<b>375 LUMEN</b>	P&R		0,25 m	
21-8004-041	1/-	<b>LED</b>	24V	900mm	-20°C bis +50°C	5700k	<b>750 LUMEN</b>	P&R		0,25 m	









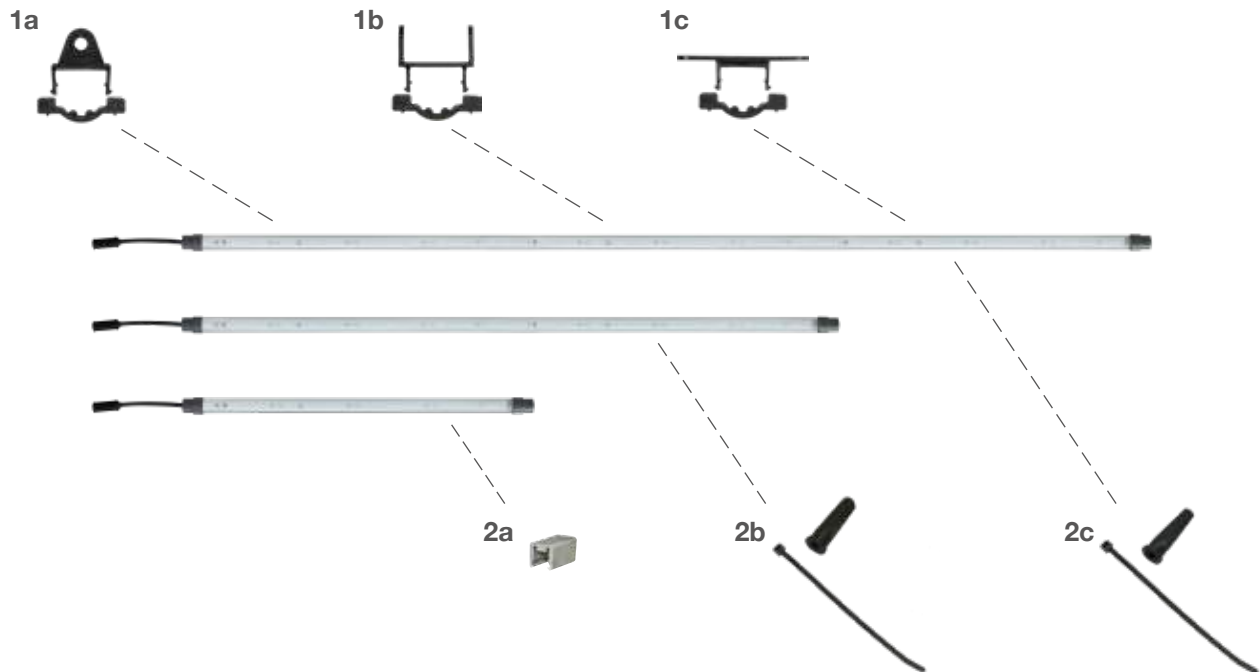

# TUBEPOINT LED

ZUBEHÖR / ACCESSORIES



## 1 Halterungen | brackets

- (a) Pendelhalter mit Verschlusskappe  
pendular bracket with fixation clip  
21-8007-144 ..... 
- (b) Halter für Profil mit Verschlusskappe  
profile bracket with fixation clip  
21-8007-154 ..... 
- (c) Halter für Direktanbau mit Verschlusskappe  
direct mounting bracket with fixation clip  
21-8007-164 ..... 

## 2 für P&R Verbinder | for P&R connector

- (a) Verschlusskappen  
caps..... 15-5971-014 
- (b) Endkappen rund  
end caps round..... 15-5983-024 
- (c) Endkappen eckig  
end caps square..... 15-5729-014 

# rspöck® E M S



## VERKABELUNGEN UND VERTEILER

Vorgefertigte Lichtanlagen sind unsere Stärke. In diesem Kapitel finden Sie alle Informationen zu den Kabeln, Verteilerboxen, Zuleitungen und Adaptern. Zusammengefasst: Zu den wichtigsten Komponenten, um unsere hochwertigen Leuchten erstrahlen zu lassen.

Unser breites Sortiment an Standard-Verkabelungssystemen für alle Segmente, stehen Ihnen ab Lager zur Verfügung. Zur Anbindung der Leitungen an die verschiedenen Systemkomponenten, bieten wir Ihnen zusätzlich eine Fülle an verfügbaren Stecker-systemen und Verteilerboxen an.

## WIRING AND JUNCTION BOXES

Pre-manufactured lighting systems are our strength. In this chapter you will find all the information about cables, junction boxes, the supply lines and adapters. In summary: Among the most important components to let our high-quality lamps shine.

Our wide range of standard wiring systems for all segments, are available from stock. To connect the cables to the various system components, we also offer you a wealth of available connector systems and junction boxes.

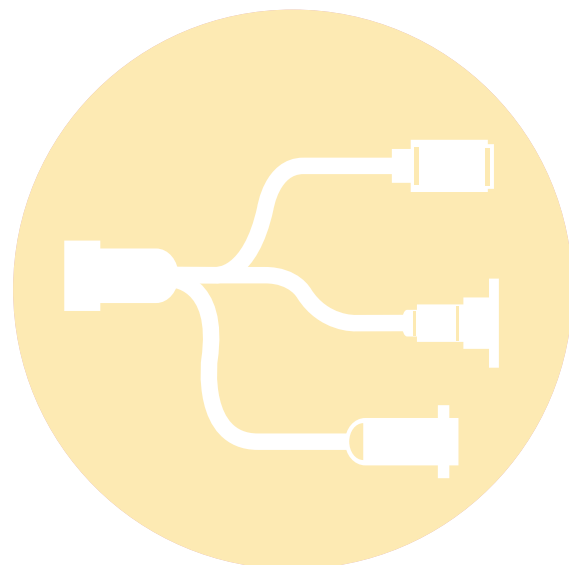



# STECKDOSENVERTEILER / SOCKET JUNCTION BOX



[A]

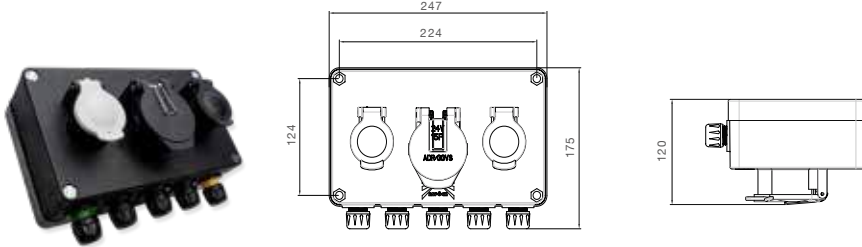

[B]



[C]

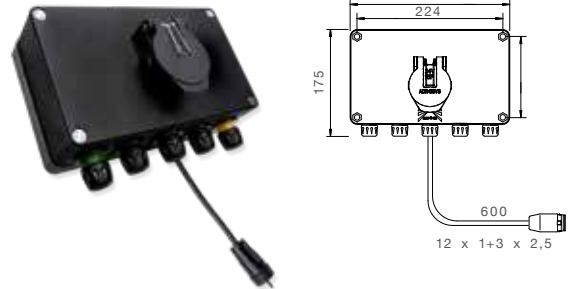

BEST. NR			BESCHREIBUNG	KABEL	ANSCHLUSS					
PART NO		V	DESCRIPTION	CABLE	CONNECTOR					
76-7037-001	1/5	24V		12 x 1,00 mm <sup>2</sup> + 3 x 2,5 mm <sup>2</sup>	15 pol. ISO 12098 15 pin ISO 12098			0,60 m		
					7 pol. ISO 1185 7 pin ISO 1185					
					7 pol. ISO 3731 7 pin ISO 3731					
					15 pol. ASS3 15 pin ASS3					
76-7069-001	1/6	24V		[A]	15 pol. ISO 12098 15 pin ISO 12098			0,60 m		
					7 pol. ISO 1185 7 pin ISO 1185					
					7 pol. ISO 3731 7 pin ISO 3731					
					17 pol. ASS3 17 pin ASS3					
15-5280-154	1/200	24V	2 Stk. ADR Sicherheitsverschlusskappen für die Steckdosen ISO 1185 und ISO 3731 2 pieces ADR safety caps for sockets ISO 1185 and ISO 3731	[B]						
76-7072-001	1/5	24V		[C]	12 x 1,00 mm <sup>2</sup> + 3 x 2,5 mm <sup>2</sup>	15 pol. ISO 12098 15 pin ISO 12098			0,60 m	
						17 pol. ASS3 17 pin ASS3				



# STECKDOSENVERTEILER SOCKET JUNCTION BOX

ZUBEHÖR / ACCESSORIES

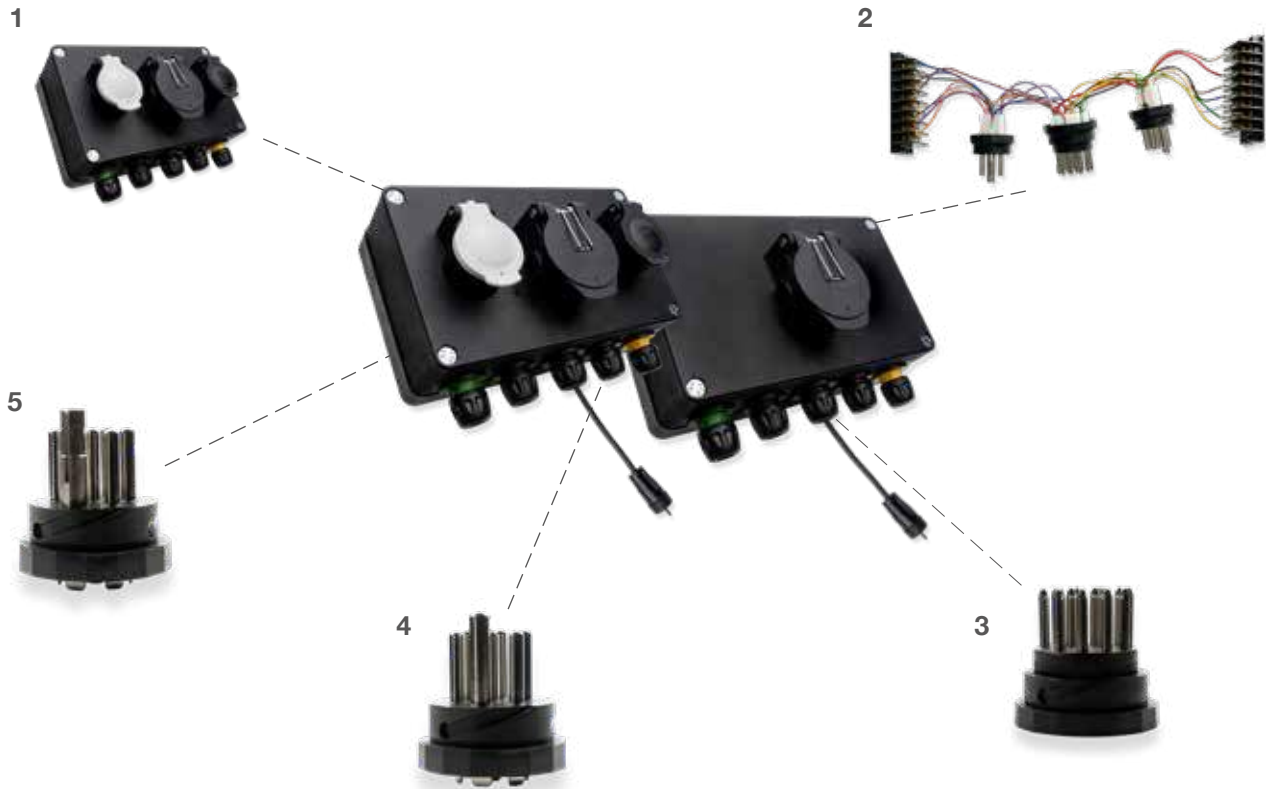

**1** Vorverkabeltes Ersatzteil für die Selbstmontage | Pre-wired spare part for self-assembly  
..... 76-7001-001

**2** Kabelsatz komplett verkabelt mit Steckleiste und Einsätze | Cable set completely wired with connector strip and inserts  
..... 58-3008-001

**3** 15 pol. Steckeinsatz ISO 12098 | 15 pin plug-in insert ISO 12098  
..... 69-0001-004

**4** 7 pol. Steckeinsatz ISO 1185 | 7 pin plug-in insert ISO 1185  
..... 69-0002-004

**5** 7 pol. teckeinsatz ISO 3731 | 7 pin plug-in insert ISO 3731  
..... 69-0003-004

**\* So wird der 3-Fach Steckdosenverteiler für ADR Zone 2 zulässig:**

Um den Steckdosenverteiler für ADR Fahrten zulässig zu machen, müssen Sie bei den Steckdosen ISO 1185 und ISO 3731 die ADR Sicherheitsverschlusskappen verwenden.

**This makes the 3-socket junction box permissible for ADR Zone 2:**

To make the socket distributor compatible with ADR travel, you must use the ADR safety caps for the ISO 1185 and ISO 3731 sockets.



## ZULEITUNGEN / FEED LINES

[A]

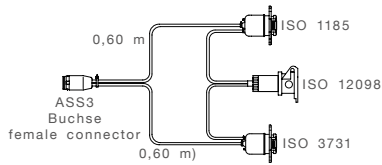

[B]

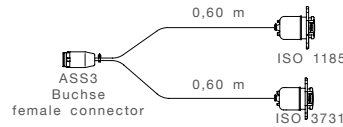

[C]



BEST. NR			ZUSATZ	ANSCHLUSS					
PART NO		V	ADD ON	CONNECTOR					
58-6647-001	1/5	24V		[A]	7 pol. ISO 1185	♂		0,80 m	
					7 pol. ISO 3731	♂			
					17 pol. ISO 12098	♀			
					17 pol. ASS3	♀			
58-6649-004	1/5	24V		[B]	17 pol. ASS3	♀		0,60 m	
					7 pol. ISO 1185	♂			
					7 pol. ISO 3731	♂			
53-6768-004	1/25	24V		[C]	17 pol. ASS3	♀		0,60 m	
					17 pol. ISO 12098	♂			



## ZULEITUNGEN / FEED LINES

[D]

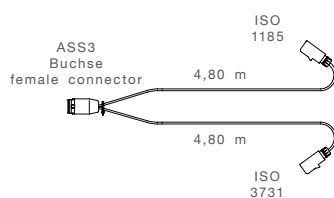

[E]



BEST. NR PART NO		V	ZUSATZ ADD ON	ANSCHLUSS CONNECTOR				
58-6024-014	1/25	24V		[D]	17 pol. ASS3 17 pin ASS3	♀		
					7 pol. ISO 1185 7 pin ISO 1185	♀	4,80 m	
					7 pol. ISO 3731 7 pin ISO 3731	♀		
53-1667-034	1/10	24V		[E]	17 pol. ASS3 17 pol. ASS3	♀	4,80 m	
					17 pol. ISO 12098 17 pol. ISO 12098	♀		



## HAUPTKABEL / MAIN CABLES

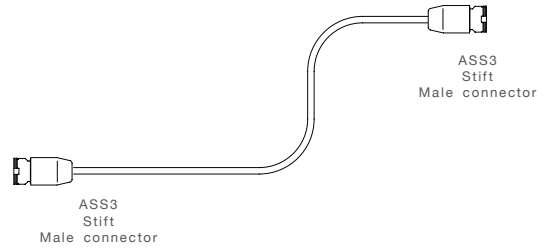

BEST. NR			KABEL	ANSCHLUSS				
PART NO		V	CABLE	CONNECTOR				
65-1003-004	1/-	24V	6 x 1,00 mm <sup>2</sup> + 2 x 2,50 mm <sup>2</sup>	2 x 17 pol. ASS3 2 x 17 pin ASS3			9,00 m	
65-1003-014	1/5	24V	6 x 1,00 mm <sup>2</sup> + 2 x 2,50 mm <sup>2</sup>	2 x 17 pol. ASS3 2 x 17 pin ASS3			12,50 m	
65-1003-021	1/-	24V	6 x 1,00 mm <sup>2</sup> + 2 x 2,50 mm <sup>2</sup>	2 x 17 pol. ASS3 2 x 17 pin ASS3			15,00 m	
65-1005-004	1/-	24V	7 x 1,00 mm <sup>2</sup> + 1 x 1,50 mm <sup>2</sup> + 2 x 2,50 mm <sup>2</sup>	2 x 17 pol. ASS3 2 x 17 pin ASS3			9,00 m	
65-1005-011	1/-	24V	7 x 1,00 mm <sup>2</sup> + 1 x 1,50 mm <sup>2</sup> + 2 x 2,50 mm <sup>2</sup>	2 x 17 pol. ASS3 2 x 17 pin ASS3			12,50 m	
65-1005-024	1/-	24V	7 x 1,00 mm <sup>2</sup> + 1 x 1,50 mm <sup>2</sup> + 2 x 2,50 mm <sup>2</sup>	2 x 17 pol. ASS3 2 x 17 pin ASS3			15,00 m	
65-1007-004	1/-	24V	12 x 1,00 mm <sup>2</sup> + 3 x 2,50 mm <sup>2</sup>	2 x 17 pol. ASS3 2 x 17 pin ASS3			9,00 m	
65-1007-014	1/3	24V	12 x 1,00 mm <sup>2</sup> + 3 x 2,50 mm <sup>2</sup>	2 x 17 pol. ASS3 2 x 17 pin ASS3			12,50 m	
65-1007-024	1/3	24V	12 x 1,00 mm <sup>2</sup> + 3 x 2,50 mm <sup>2</sup>	2 x 17 pol. ASS3 2 x 17 pin ASS3			15,00 m	





# VERTEILERBOX ASS1 / JUNCTION BOX ASS1

IP54

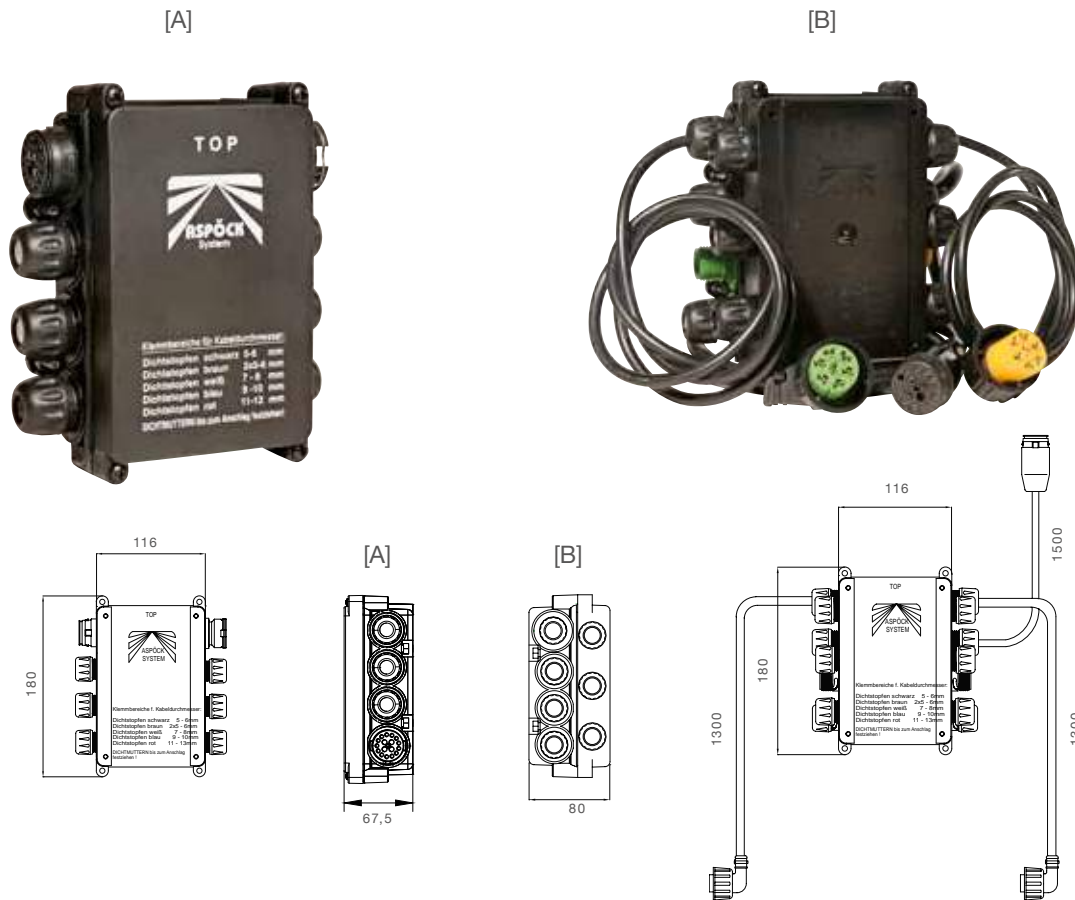

BEST. NR PART NO			ZUSATZ ADD ON	ANSCHLUSS CONNECTOR			
76-6430-001	1/1	24V		B	2 x 7 pol. ASS2 2 x 7 pin ASS2	 1,30 m	
				B	17 pol. ASS3 17 pin ASS3	 1,50 m	
76-5123-001	1/-	24V		A	17 pol. ASS3 17 pin ASS3		
				A	17 pol. ASS3 17 pin ASS3		
76-5123-111	1/-	24V		A	17 pol. ASS3 17 pin ASS3		
				A	17 pol. ASS3 17 pin ASS3		
				A	2 pol. ASS2 2 pin ASS2		



# VERTEILERBOX ASS1 JUNCTION BOX ASS1

ZUBEHÖR / ACCESSORIES

IP 54

1

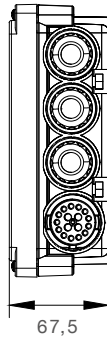

2

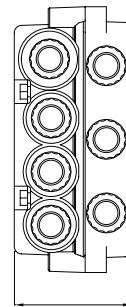

80

**1** Verteilerbox mit hohem Deckel |  
Junction box with high cap  
..... 76-5100-001 







**2** Verteilerbox mit niederem Deckel |  
Junction box with low cap  
..... 76-5100-041 

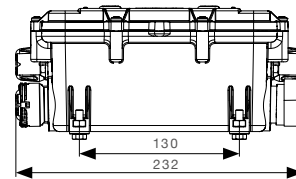
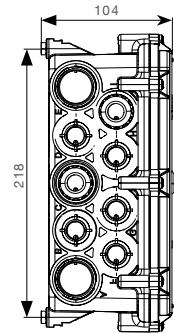
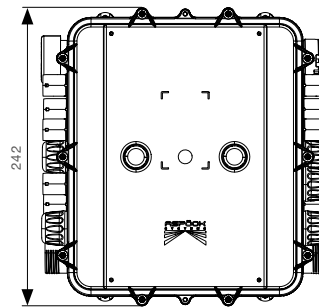

# VERTEILERBOX XL / JUNCTION BOX XL

IP 56K



BEST. NR			BESCHREIBUNG	ANSCHLUSS	
PART NO			DESCRIPTION	CONNECTOR	
76-5203-001	1/-	24V	Verteilerbox XL Junction box XL	17 pol. ASS3 17 pin ASS3	 
				17 pol. ASS3 17 pin ASS3	 



# VERKABELUNG SML / SML WIRING

[A]

[B]

[C]

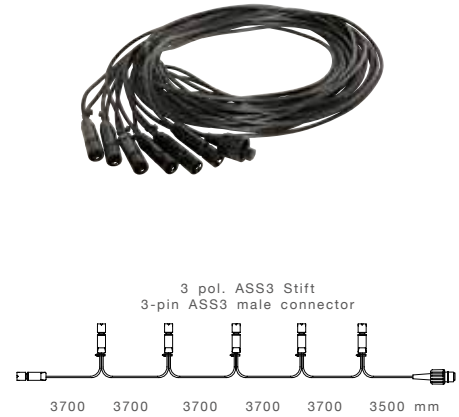

BEST. NR			BESCHREIBUNG	KABEL		ANSCHLUSS					
PART NO			DESCRIPTION	CABLE		CONNECTOR					
68-7503-041	1/-	24V	P&R Flachkabel Kabelmarkierung weiß	2 x 1,50 mm <sup>2</sup>	[A]	2 pol. ASS2 2 pin ASS2				10,00 m	
68-7503-004	1/-	24V	P&R flat cable cable marking white			2 pol. ASS2 2 pin ASS2				13,00 m	
68-7502-361	1/-	24V	P&R Flachkabel Kabelmarkierung gelb/grün P&R flat cable cable marking yellow/green			2 pol. ASS2 2 pin ASS2				13,00 m	
68-7503-011	1/5	24V				2 pol. ASS2 2 pin ASS2				15,00 m	
68-7503-174	1/-	24V	P&R Flachkabel Kabelmarkierung weiß P&R flat cable cable marking white			2 pol. ASS2 2 pin ASS2				16,00 m	
68-7503-021	1/5	24V				2 pol. ASS2 2 pin ASS2				17,00 m	
68-7502-371	1/-	24V	P&R Flachkabel Kabelmarkierung gelb/grün P&R flat cable cable marking yellow/green			2 pol. ASS2 2 pin ASS2				17,00 m	
87-1284-004	1/5	24V		2 x 1,00 mm <sup>2</sup>	[B]	2 pol. ASS2 2 pin ASS2				5,50 m	
						5 x 2 pol. ASS3 5 x 2 pin ASS3				3,70 m	
87-1285-004	1/-	24V		2 x 1,00 mm <sup>2</sup>	[C]	2 pol. ASS2 2 pin ASS2				3,50 m	
						6 x 2 pol. ASS3 6 x 2 pin ASS3				3,70 m	



## VERTEILERLEITUNG HINTEN / REAR SUPPLY HARNESS

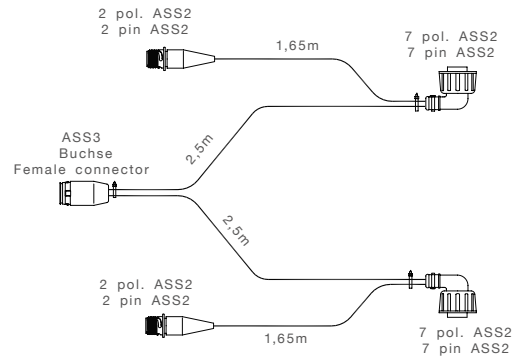

BEST. NR PART NO		24V	BESCHREIBUNG DESCRIPTION	ZUSATZ ADD ON	KABEL CABLE	ANSCHLUSS CONNECTOR				
68-4800-004	1/10	24V			7 x 1,00 mm <sup>2</sup>	17 pol. ASS3 17 pin ASS3	♀		2 x 2,50 m	
			2 x 7 pol. ASS2 2 x 7 pol. ASS2	♂						
68-4983-004	1/10	24V			7 x 1,00 mm <sup>2</sup>	17 pol. ASS3 17 pin ASS3	♀		2 x 2,50 m	
			2 x 7 pol. ASS2 2 x 7 pin ASS2	♀						
			P&R Flachkabel P&R flat cable		2 x 2 x 1,50 mm <sup>2</sup>	2 x 2 pol. ASS2 2 x 2 pin ASS2	♂		2 x 1,70 m	
68-4855-001	1/10	24V			2 x 7 x 1,00 mm <sup>2</sup>	17 pol. ASS3 17 pin ASS3	♀		2 x 3,00 m	
			2 x 7 pol. ASS2 2 x 7 pin ASS2	♀			1,00 m			
			P&R Flachkabel P&R flat cable		2 x 1,50 mm <sup>2</sup>					
68-4888-004	1/10	24V			7 x 1,00 mm <sup>2</sup>	17 pol. ASS3 17 pin ASS3	♀		2 x 2,50 m	
			2 x 7 pol. ASS2 2 x 7 pin ASS2	♀						
					2 x 0,75 mm <sup>2</sup>	2 x 2 pol. ASS2 2 x 2 pin ASS2	♂		2 x 0,70 m	



# ADAPTERKABEL / ADAPTER CABLES

[A]



[B]

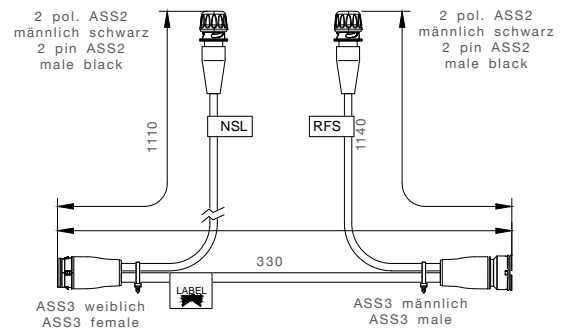
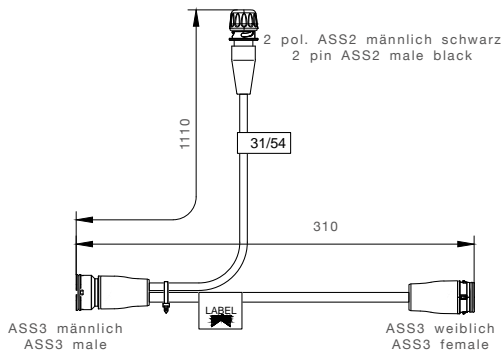

BEST. NR			BESCHREIBUNG	KABEL	ANSCHLUSS				
PART NO		V	DESCRIPTION	CABLE	CONNECTOR				
66-8892-004	1/-	24V	8 adriges Kabel 8 core cable	6 x 1,00 mm <sup>2</sup> 2 x 2,50 mm <sup>2</sup>	[A]	17 pol. ASS3 17 pin ASS3			
			1 x Abgang Bremsleuchte 1 x outlet stop lamp	3 x 2,50 mm <sup>2</sup>		2 pol. ASS2 2 pin ASS2			
66-8893-004	1/-	24V	9 adriges Kabel 9 core cable	9 x 1,00 mm <sup>2</sup>	[B]	17 pol. ASS3 17 pin ASS3			
			2 x Abgang für RFS und NSL 2 x outlet for reverse lamp and fog lamp	2 x 1,00 mm <sup>2</sup>		2 x 2 pol. ASS2 2 x 2 pin ASS2			



## ADAPTERKABEL / ADAPTER CABLES

[C]

[D]

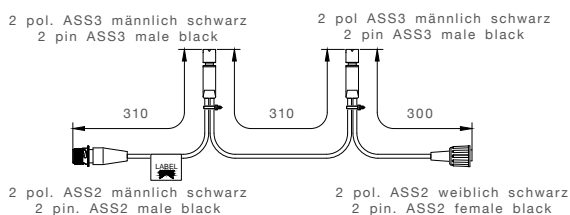
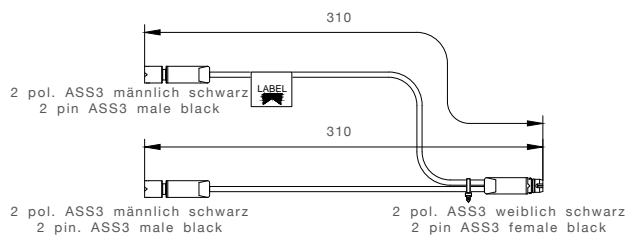

BEST. NR			BESCHREIBUNG	KABEL		ANSCHLUSS
PART NO		V	DESCRIPTION	CABLE		CONNECTOR
65-6499-004	1/-	24V	Y-Kabel Y-cable	2 x 1,00 mm <sup>2</sup>	[C]	2 x 2 pol. ASS3 2 x 2 pin ASS3 
87-1286-004	1/-	24V	Verlängerungsstück für SML Kette Extension piece for SML chain	2 x 1,00 mm <sup>2</sup>	[D]	2 pol. ASS2 2 pin ASS2 
						2 pol. ASS2 2 pin ASS2 
						2 x 2 pol. ASS2 2 x 2 pin ASS2 



## ADAPTERKABEL / ADAPTER CABLES

[E]



[F]

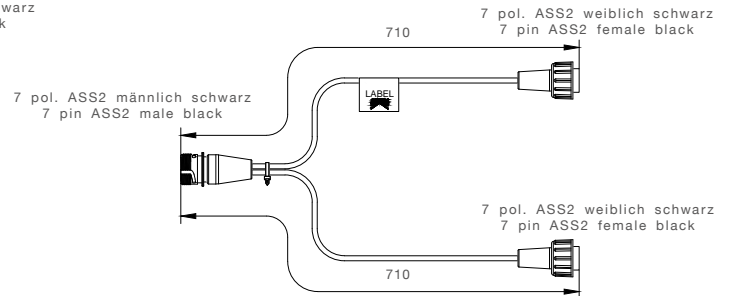
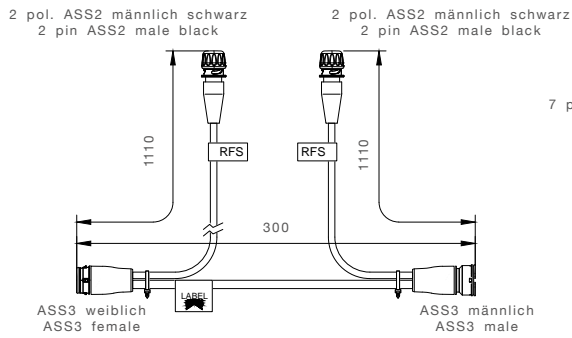
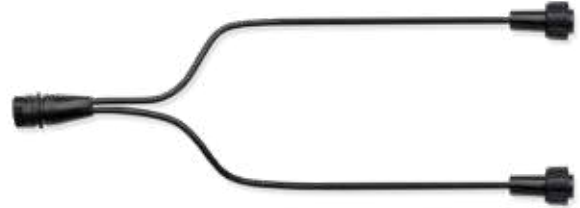

BEST. NR PART NO			BESCHREIBUNG DESCRIPTION	KABEL CABLE	ANSCHLUSS CONNECTOR			
65-6101-024	1/-	24V	9 adriges Kabel 9 core cable	9 x 1,00 mm <sup>2</sup>	[E]	17 pol. ASS3 17 pin ASS3		
			2 x Abgang für RFS 2 x outlet for reverse lamp	2 x 1,00 mm <sup>2</sup>		2 x 2 pol. ASS2 2 x 2 pin ASS2		
68-4980-034	1/-	24V	Adapter Doppelbeleuchtung Adapter double lighting	7 x 1,00 mm <sup>2</sup>	[F]	7 pol. ASS2 7 pin ASS2		
						2 x 7 pol. ASS2 2 x 7 pin ASS2		





## VERLÄNGERUNGSKABEL / EXTENSION CABLES

[A]



[B]

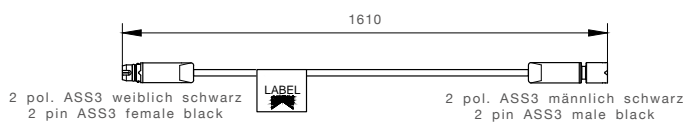

BEST. NR PART NO			KABEL CABLE	ANSCHLUSS CONNECTOR
65-1499-004	1/-	24V	2 x 1,00 mm <sup>2</sup>	[A] 2 pol. ASS3 2 pin ASS3   
				[A] 2 pol. ASS3 2 pin ASS3   
65-1499-014	1/-	24V		[B] 2 pol. ASS3 2 pin ASS3   
				[B] 2 pol. ASS3 2 pin ASS3   

**FASFPÖÖKX<sup>®</sup>**

**S Y S T E M S**

## ZUBEHÖR

Zusätzlich zu den gesetzlich vorgeschriebenen, sicherheitsrelevanten Fahrzeugkomponenten bieten wir Ihnen noch weitere Systeme für spezielle Anwendungsbereiche an. Sie schützen den Fahrzeugenker und unterstützen ihn beim Handling mit dem Fahrzeug zusätzlich.

Auf den nächsten Seiten finden Sie für diesen Zweck unsere Warnsysteme, Kontrollgeräte, den neuen Unterfahrschutz und alle Aspöck-Verbinder im Überblick.

## ACCESSORIES

In addition to the legally required, safety-relevant vehicle components, we also offer other systems for special uses. They protect the driver and provide additional support while handling the vehicle.

On the next pages you will find an overview of our warning systems, control devices, the new underrun protection and all Aspöck connectors for this purpose.

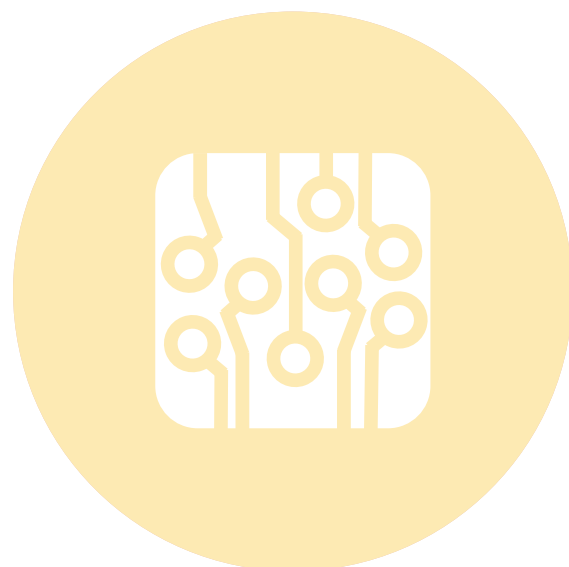



# RADC 1.0



Produktinformation  
Product information

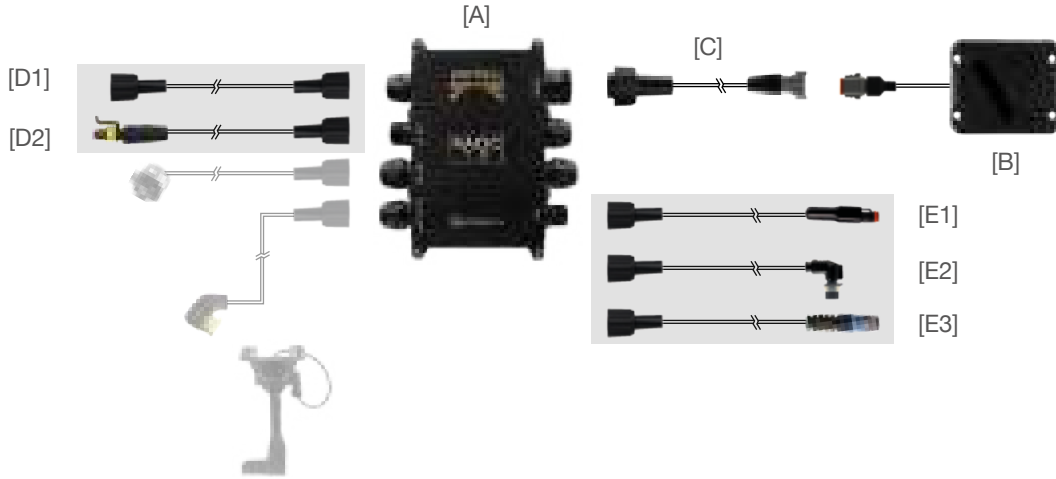

BEST. NR				BESCHREIBUNG		ANSCHLUSS					
PART NO				DESCRIPTION		CONNECTOR					
76-5158-001	1/-		24V	1.0 Verteilerbox 1.0 Junction Box	[A]						
75-0213-044	1/-		24V	Sensor W 2,4 m / L 3,0 m Sensor W 2,4m / L 3,0m	[B]	8 pol. DT06 8 pin DT06	♀			2,50 m	
65-1512-004	1/-		24V	Sensor Anschlusskabel Sensor Connection cable	[C]	7 pol. ASS2 7 pin ASS2 8 pol. DT04 8 pin DT04	♀			3,00 m	
68-0076-004	1/-		24V	Anschlusskabel ASS2 Connection cable ASS2	[D1]	2 x 2 pol. ASS2 2 x 2 pin ASS2	♀			3,00 m	
68-0070-004	1/10		24V	Anschlusskabel Superseal Connection cable Superseal	[D2]	2 pol. ASS2 2 pin ASS2 2 pol. Superseal 2 pin Superseal	♀			6,00 m	
69-0078-014	1/40		24V	Knorr EBS Verbindung Knorr EBS Connection	[E1]	2 pol. ASS2 2 pin ASS2	♀			3,00 m	
				2 pol. DT06 2 pin DT06		♀					
68-0002-334				Knorr EBS Verbindung 1 pol. Knorr EBS Connection 1 pin		1 pol. DT 1 pin DT	♀			6,00 m	
78-7013-004	1/50		24V	Wabco/ZF EBS Verbindung Wabco/ZF EBS Connection	[E2]	2 pol. ASS2 2 pin ASS2 3 pol. Wabco Verbinder 3 pin Wabco connector	♀			4,00 m	
68-0049-014	1/20		24V	Haldex EBS Verbindung Haldex EBS Connection	[E3]	2 pol. ASS2 2 pin ASS2 3 pol. Haldexstecker 3 pin Haldex connector	♀			7,00 m	



# RADC 1.0



BEST. NR				BESCHREIBUNG		ANSCHLUSS					
PART NO				DESCRIPTION		CONNECTOR					
39-9093-004	1/36	<b>LED</b>	24V	Status Leuchte Status lamp	[F]	6 pol. HDSCS 6 pin HDSCS	♂				
69-6268-004	1/-		24V	Status Leuchten Anschlusskabel Status lamp Connection cable	[G]	2 pol. ASS2 2 pin ASS2	♀			6,00 m	
						6 pol. HDSCS 6 pin HDSCS	♀				
75-0001-004	1/25		24V	Rückfahrbeeper Reversing beeper	[H]	2 pol. ASS2 2 pin ASS2	♀			4,00 m	



## RDC PREMIUM - KIT



Produktinformation  
Product information



RDC  
Premium  
Video  
RDC  
premium  
video

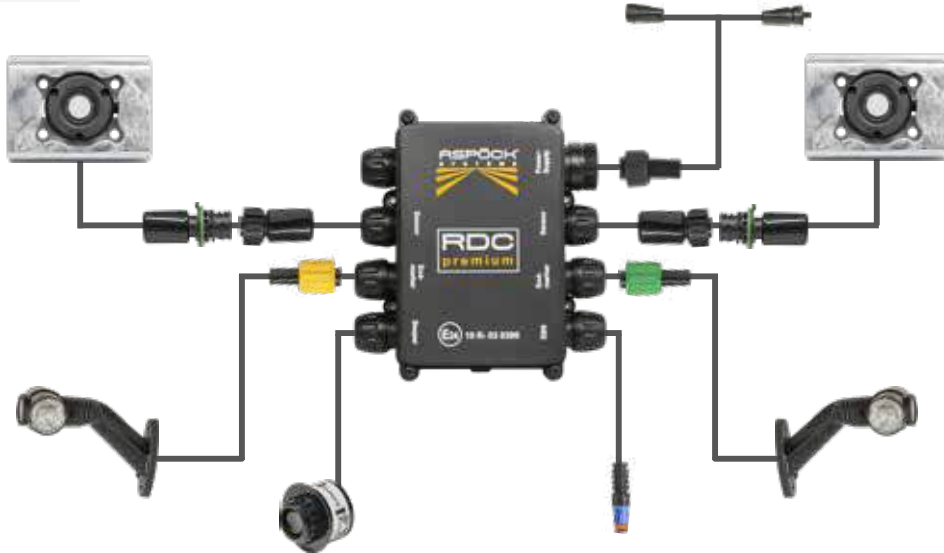

BEST. NR PART NO				BESCHREIBUNG DESCRIPTION
99-3010-244	1/-	LED	24V	RDC - Premium Haldex ohne Metallpuffer RDC - Premium Haldex without metal buffer
99-3010-224	1/-	LED	24V	RDC - Premium Knorr TEBS G2.1 ohne Metallpuffer RDC - Premium Knorr TEBS G2.1 without metal buffer
99-3010-294	1/1	LED	24V	RDC - Premium Knorr TEBS G.2.2. mit Metallpuffer RDC - Premium Knorr TEBS G.2.2. including metal buffer
99-3010-284	1/-	LED	24V	RDC - Premium Knorr TEBS G.2.2. ohne Metallpuffer RDC - Premium Knorr TEBS G.2.2. without metal buffer



# RDC PREMIUM EINZELTEILE / INDIVIDUAL PARTS

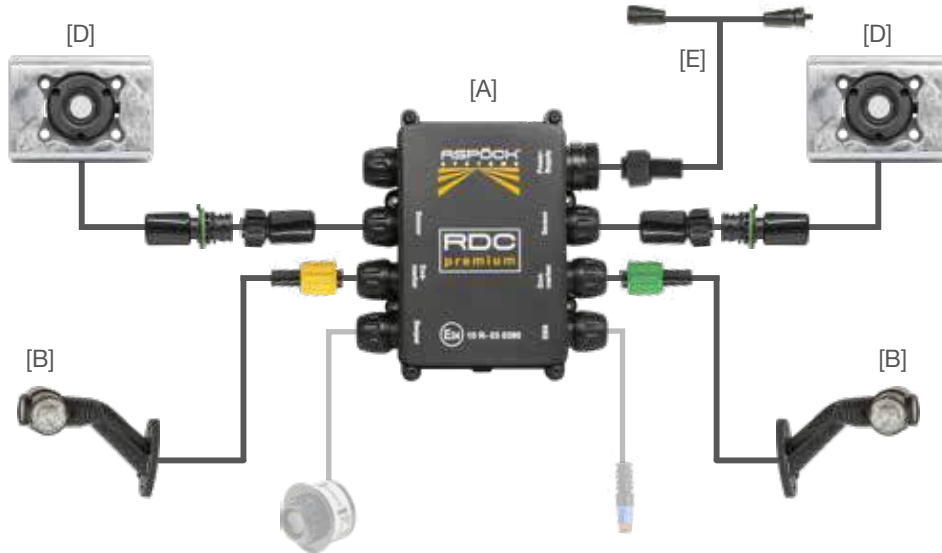

BEST. NR PART NO						BESCHREIBUNG DESCRIPTION	ANSCHLUSS CONNECTOR					
76-6425-101	1/10				24V	RDC Verteiler Box Haldex RDC Junction box Haldex	[A] 2 x 4 pol. AMP 2 x 4 pin AMP				1,00 m	
76-6425-201	1/10				24V	RDC Verteiler Box Knorr f. TEBS G21 & 2.2 Premium RDC Junction box Knorr f. TEBS G21 & 2.2 Premium	[A] 2 x 4 pol. AMP 2 x 4 pin AMP				1,00 m	
31-3306-044	1/40				24V	URL Superpoint III LED	[B] 2 pol. ASS2 2 pin ASS2				2,10 m	
31-3305-044												
75-0001-004	1/25				24V	Rückfahrbeeper Rerversing beeper	[C] 2 pol. ASS2 2 pin ASS2				4,00 m	
75-0201-611	1/-				24V	RDC Sensor mit Metallpuffer RDC Sensor including metal buffer	[D] 2 x 4 pol. AMP 2 x 4 pin AMP				1,00 m	
75-0204-111	1/32				24V	RDC Sensor ohne Metallpuffer RDC Sensor ohne Metallpuffer	[D] 2 x 4 pol. AMP 2 x 4 pin AMP				1,00 m	



## RDC PREMIUM EINZELTEILE / INDIVIDUAL PARTS

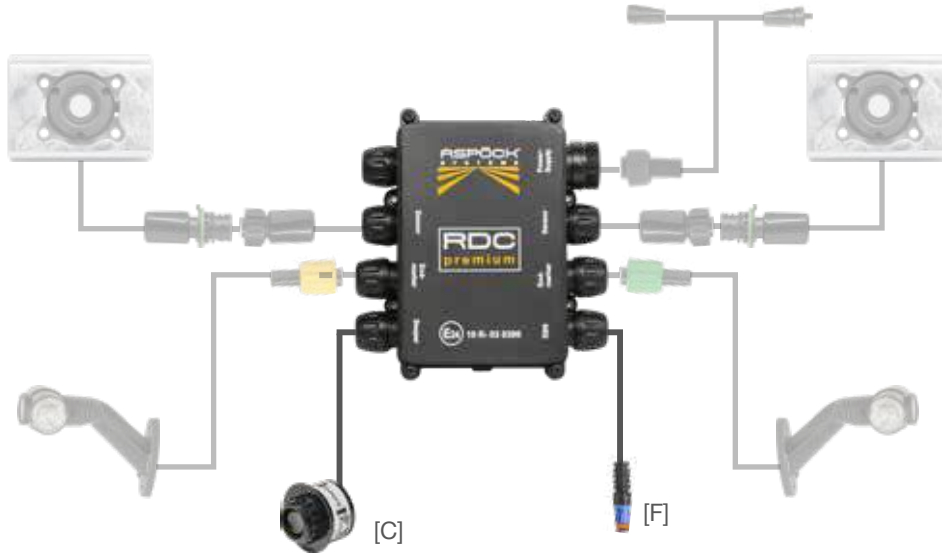

BEST. NR			BESCHREIBUNG	ANSCHLUSS				
PART NO			DESCRIPTION	CONNECTOR				
75-0001-004	1/25	24V	Rückfahrbeeper Reversing beeper	2 pol. ASS2 2 pin ASS2			4,00 m	
65-6003-011	1/20	24V	Anschlusskabel Connector cable	7 pol. ASS2 7 pin ASS2			3,00 m	
				ASS3 Stift ASS3 pin				
65-6003-001	1/15	24V	Anschlusskabel Connector cable	ASS3 Buchse ASS3 socket			8,00 m	
				7 pol. ASS2 7 pin ASS2				
				ASS3 Stift ASS3 pin				
68-0049-014	1/20		EBS Verbindungskabel Haldex EBS Connection cable Haldex	2 pol. ASS2 2 pin ASS2			7,00 m	
				3 pol. Haldexstecker 3 pin Haldex connector				
68-0111-004	1/25		EBS Verbindungskabel Knorr TEBS G2.1 P. EBS Connection cable Knorr TEBS G2.1 P.	2 pol. ASS2 2 pin ASS2			3,00 m	
69-0078-014	1/25		EBS Verbindungskabel Knorr TEBS G2.2 P. EBS Connection cable Knorr TEBS G2.2 P.	2 pol. ASS2 2 pin ASS2			3,00 m	
				2 pol. DT06 Buchse 2 pin DT06 socket				





# RÜCKFAHRWAHRNER / BEEPER

[A]



[B]

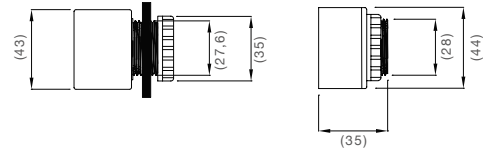

BEST. NR				BESCHREIBUNG		ANSCHLUSS				
PART NO				DESCRIPTION		CONNECTOR				
75-0000-004	1/50		24V		[A]	IP 68	2 pol. ASS2 2 pin ASS2	♀	1,20 m	
75-0100-004	1/30		24V	Rückfahrbeeper Reversing beeper	[A]	IP 68	Offenes Ende open end		3,50 m	
75-0002-004	1/24		24V		[A]	IP 54	Offenes Ende open end		1,20 m	
12-3922-004	1/50		24V	Rückfahrrelais für Europoint I + III Reversing relay for Europoint I + III	[B]					
12-3922-014	1/10		24V	Rückfahrrelais für Europoint II Reversing relay for Europoint II	[B]					



SMCG SEITENMARKIERUNGSKONTROLLGERÄT / SIDEMARKER CONTROL GEAR



Produktinformation  
Product information

[A]

[B]

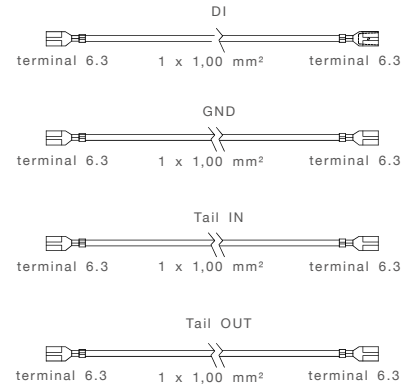
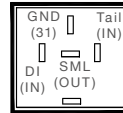
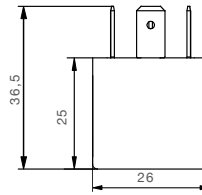
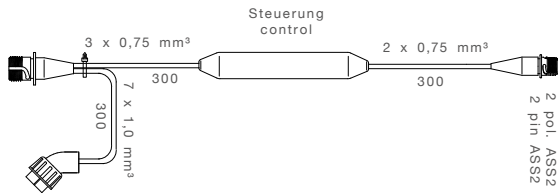

BEST. NR					BESCHREIBUNG	ANSCHLUSS	
PART NO		V	←	→	DESCRIPTION	CONNECTOR	
75-0328-001	1/25	24V		●		7 pol. ASS2 7 pin ASS2	♀ ♂
75-0329-001	1/25	24V	●			7 pol. ASS2 7 pin ASS2	♀ ♂
75-0331-001	1/25	24V	●	●		2 x 2 pol. ASS2 2 x 2 pin ASS2	♀ ♂
75-0360-004	1/15	24V			Hauptkabelverbindung mit SMCG Abgänge 2 pol. Main connection cable with SMCG departures 2 pin	17 pol. ASS3 17 pin ASS3	♀ ♂
75-0326-034	1/150	24V			Verbindungskabel connection cable	2 x 3 pol. ASS3 2 x 3 pin ASS3	♂
68-4888-004	1/-	24V	●	●	Verteilerleitung Distribution line	17 pol. ASS3 17 pin ASS3	♀ ♂
12-3970-584	1/-				Lampenrelais für SMCG Lamp relay for SMCG	4 x 1 x 1,0 mm <sup>2</sup> mit Flachstecker 6,30 x 0,80 mm 4 x 1 x 1,0 mm <sup>2</sup> with flat plug 6.30 x 0.80 mm	

A

B



ERD ELEKTRISCHE RÜCKFAHRLICHTSTEUERUNG / ELECTRIC REVERSING DEVICE



Produktinformation  
Product information

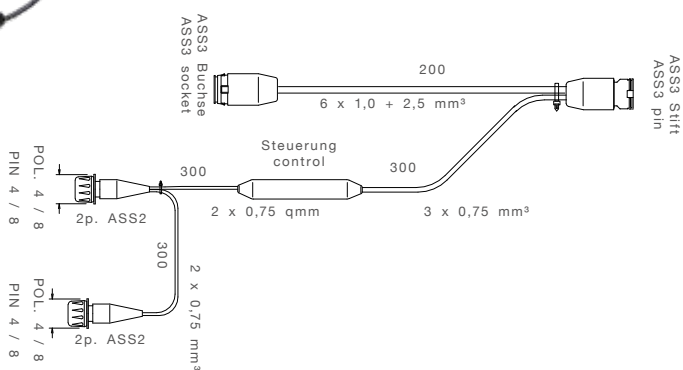

BEST. NR PART NO				ZUSATZ ADD ON	ANSCHLUSS CONNECTOR
75-0341-001	1/20		24V		17 pol. ASS3 17 pin ASS3
					17 pol. ASS3 17 pin ASS3
					2 x 2 pol. ASS2 2 x 2 pin ASS2



# SMARTLINK - SUPERSEAL



Produktinformation  
Product information

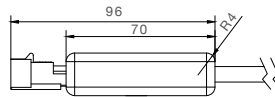
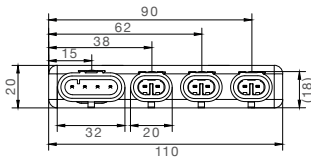
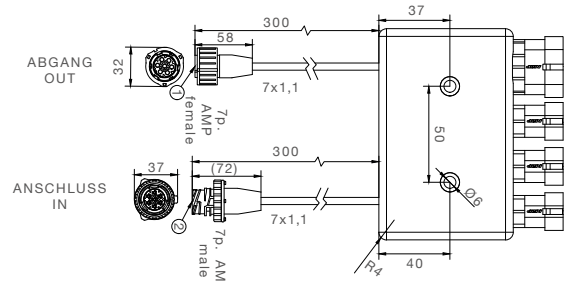

BEST. NR PART NO			ZUSATZ ADD ON	C°	FUNKTION FUNCTION	ANSCHLUSS CONNECTOR
76-9035-021	1/-	24V	max. 10A (pro Abgang max. 2A) max. 10A (pro departure max. 2A)	+40°C - +50°C +40°C - +50°C		7 pol. AMP 7 pin AMP Eingang In Ausgang Out
						4 pol. Superseal 4 pin Superseal
						3 x 2 pol. Superseal 3 x 2 pin Superseal
76-9035-031	1/-	24V	max. 10A (pro Abgang max. 2A) max. 10A (pro departure max. 2A)	+40°C - +50°C +40°C - +50°C		Offenes Ende open end Eingang In Ausgang Out
						4 pol. Superseal 4 pin Superseal
						3 x 2 pol. Superseal 3 x 2 pin Superseal



# SMARTLINK - SUPERSEAL

ZUBEHÖR / ACCESSORIES

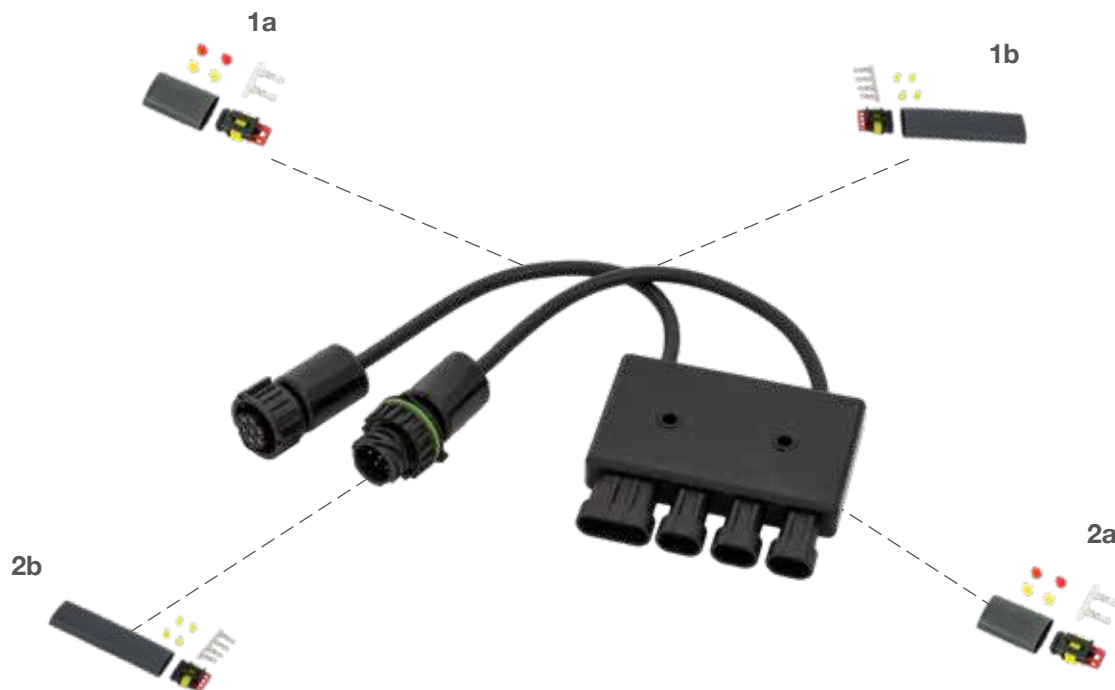

## 1 SET Smartlink Verbinder | SET Smartlink connector

(a) 3 x 2 pol. weiblich  
3 x 2 pin female

(b) 1 x 4 pol. weiblich  
1 x 4 pin female

..... 13-3424-184 

## 2 Superseal Verbinder | Superseal connector

(a) 2 pol. weiblich  
2 pin female ..... 15-7002-044 

(b) 4 pol. weiblich  
4 pin female ..... 15-7002-084 



# VERBREITERUNG / EXPANSIONS

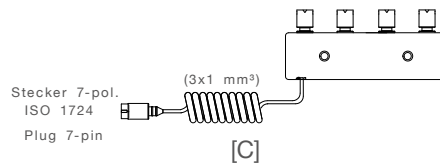
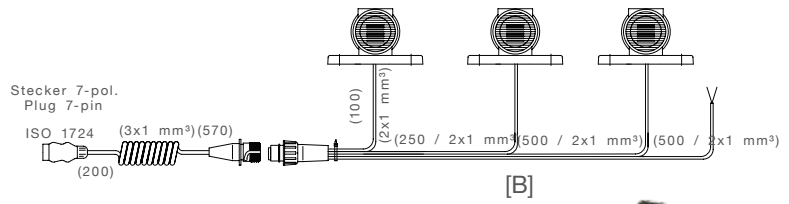
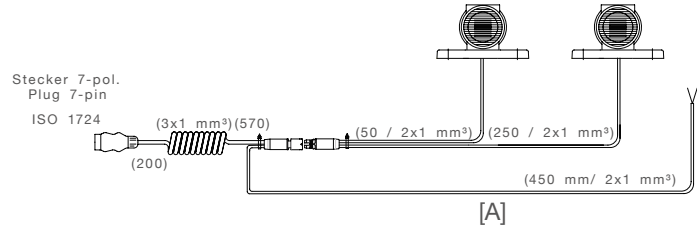

BEST. NR PART NO					ZUSATZ ADD ON	ANSCHLUSS CONNECTOR
58-1955-004	1/-	24V			Verbreiterung mit 2 Stk. Superpoint III LED mit zusätzlichen Abgang für Drehlicht Expansion with 2 pieces Superpoint II LED with additional outlet for rotating	[A] 7 pol. ISO 1724 7 pin ISO 1724 3 pol. ASS3 3 pin ASS3 3 pol. ASS3 3 pin ASS3
58-1957-004	1/-	24V			Verbreiterung mit 3 Stk. Superpoint III LED mit zusätzlichen Abgang für Drehlicht Extension with 3 pcs. Superpoint III LED with additional outlet for rotating light	[B] 7 pol. ISO 1724 7 pin ISO 1724 7 pol. ASS2 7 pin ASS2 7 pol. ASS2 7 pin ASS2
76-9023-001	1/-	24V			Steckverbinder mit Wendelkabel Connector with coiled cable	[C] 4 x 3 pol. ASS3 4 x 3 pin ASS3 7 pol. ISO 1724 7 pin ISO 1724
31-3307-084	1/25	24V	●	●	Superpoint III LED passend zu 76-9023-004 Superpoint III LED suitable for 76-9023-007	[D] 3 pol. ASS3 3 pin ASS3 0,25 m



# UNTERFAHRSCHUTZ / UNDERRUN PROTECTION



Produktinformation  
Product information

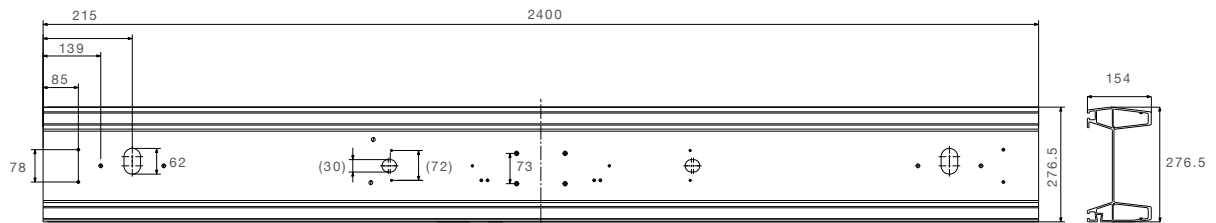
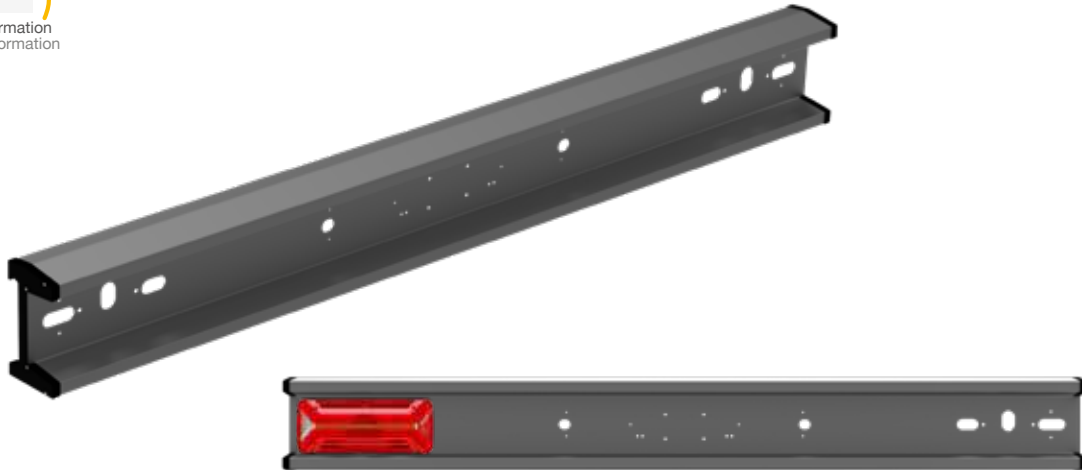

BEST. NR PART NO		BESCHREIBUNG DESCRIPTION	
97-1103-021	1/-	Unterfahrerschutz gemäß ECE58 R03, eloxiertes Aluminium, für 3 Kammerleuchte Underrun protection according to ECE58 R03, anodised aluminium, for 3-chamber lamp	2,40 m
97-1104-021	1/-	Unterfahrerschutz gemäß ECE58 R03, eloxiertes Aluminium, für 5 Kammerleuchte Underrun protection according to ECE58 R03, anodised aluminium, for 5-chamber lamp	2,40 m
97-1105-021	1/-	Unterfahrerschutz gemäß ECE58 R03, eloxiertes Aluminium, ungebohrt Underrun protection according to ECE58 R03, anodised aluminium, undrilled	2,40 m
97-1106-021	1/-	Unterfahrerschutz gemäß ECE58 R03, eloxiertes Aluminium, Standard Underrun protection according to ECE58 R03, anodised aluminium, standard	2,40 m
97-1107-021	1/-	Unterfahrerschutz gemäß ECE58 R03, Aluminium weiß, ungebohrt Underrun protection according to ECE58 R03, aluminium white, undrilled	2,40 m



# UNTERFAHRSCHUTZ / UNDERRUN PROTECTION

ZUBEHÖR / ACCESSORIES

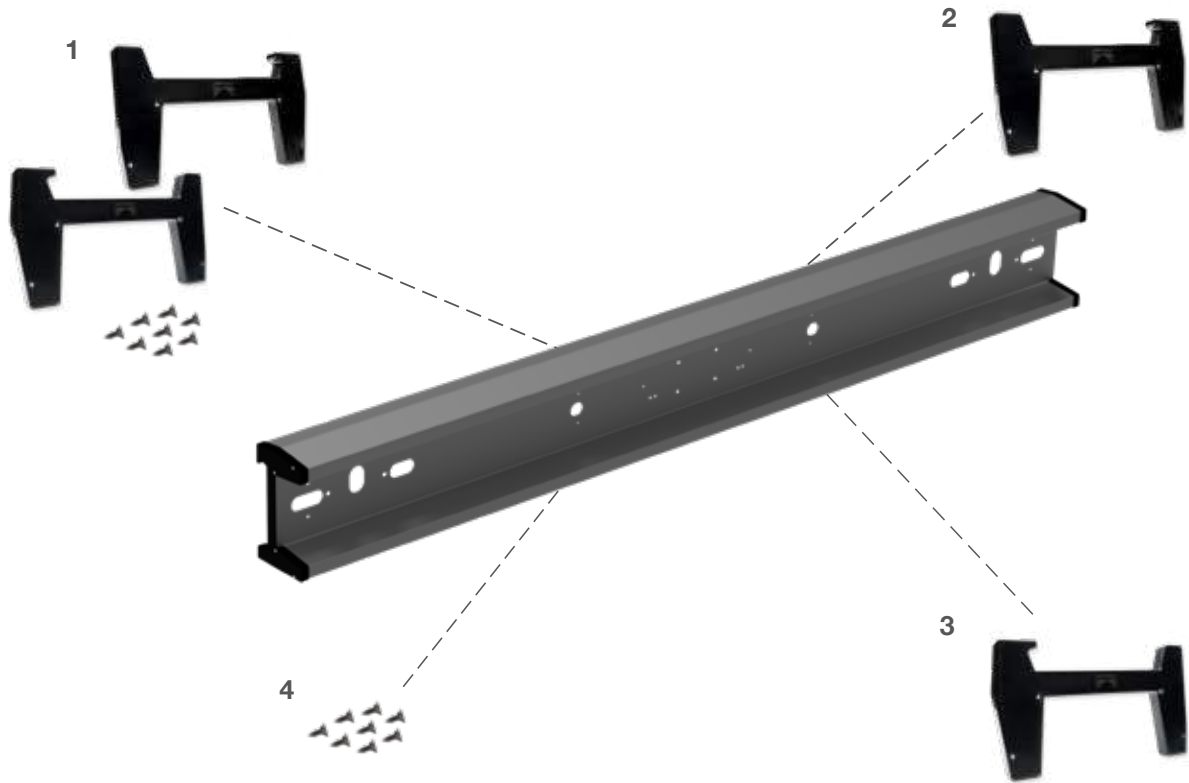

**1** Endkappen L/R + Schrauben für  
Unterfahrerschutz |  
End caps L/R + Screws for  
underrun protection

..... 15-7203-004 

**2** Endkappe links für Unterfahrerschutz |  
End cap left for underrun protection

..... 15-5272-004 

**3** Endkappe rechts für Unterfahrerschutz |  
End cap left for underrun protection

..... 15-5272-014 

**4** Schrauben für Endkappen |  
Screws for end caps

..... 14-1964-004 



## LCG

## ÜBERSICHT / OVERVIEW

	LCG 1 - V2	LCG 2		LCG 3 UNIVERSAL
BEST. NR PART NO	75-0300-101	75-0310-001	75-0309-001	76-5132-011
		1/10	1/10	
	24V	24V	24V	24V
ANHÄNGERERKENNUNG TRAILER DETECTION				
LED AUSFALLÜBERWACHUNG LED FAILURE DETECTION				
SIMULATION GLÜHBIRNE				
POWER SIMULATION OF A BULB				
BENÖTIGTE MENGE PRO FAHRZEUG QUANTITY REQUIRED PER VEHICLE	2	1	1	1
DAUERPLUS BENÖTIGT PERMANENT POWER REQUIRED				●
KANN BEI FOLGENDEN LEUCHTEN VERWENDET WERDEN	bei allen Aspöck Heckleuchten ohne integriertem LCG	bei allen Aspöck Heckleuchten ohne integriertem LCG	bei allen Aspöck Heckleuchten mit integriertem LCG für Blinker	bei allen Aspöck Heckleuchten ohne integriertem LCG
USABLE FOR THE FOLLOWING LAMPS	All Aspöck rear lamps without integrated LCG	All Aspöck rear lamps without integrated LCG	All Aspöck rear lamps with integrated LCG for direction indicator	All Aspöck rear lamps without integrated LCG

LCG

ÜBERSICHT / OVERVIEW

	LCG UNIVERSAL 	LCG UNIVERSAL 	LCG EUROPOINT III 
			
BEST. NR	75-0324-001	75-0314-001	25-7008-024
PART NO			
			1/6
	24V	12-30V	12-30V
ANHÄNGERERKENNUNG TRAILER DETECTION			
LED AUSFALLÜBERWACHUNG LED FAILURE DETECTION			
SIMULATION GLÜHBIRNE			
POWER SIMULATION OF A BULB			
BENÖTIGTE MENGE PRO FAHRZEUG	1	2	2
QUANTITY REQUIRED PER VEHICLE			
DAUERPLUS BENÖTIGT PERMANENT POWER REQUIRED			
KANN BEI FOLGENDEN LEUCHTEN VERWENDET WERDEN	bei allen Aspöck Heckleuchten ohne integriertem LCG für Bremslicht	bei allen Aspöck Heckleuchten ohne integriertem LCG für Blinker	Europoint III
USABLE FOR THE FOLLOWING LAMPS	All Aspöck rear lamps without integrated LCG for stop light	All Aspöck rear lamps without integrated LCG for direction indicator	

## Allgemeiner Hinweis zum LCG!

In Hinsicht auf den geringen Leistungsverbrauch von LED Leuchten gegenüber Glühlampenleuchten kann es im Betrieb bei verschiedenen Zugfahrzeugen zu Problemen mit der Glühlampenausfallkontrolle kommen. Der geringe Leistungsverbrauch von LED Leuchten wird von vielen Zugfahrzeugen als ein Ausfall der Lichtfunktion gesehen und kann im Fahrzeuginneren zu einer visuellen Fehlermeldung führen.

Da die Kontrolle der Blinkerfunktion gesetzlich vorgeschrieben ist empfehlen wir die Aspöck LED Leuchten in Verbindung mit einem LED Control- Gerät „LCG“ zu betreiben.

Aspöck übernimmt keine Haftung für die Funktionalität an allen Zugfahrzeugen und befreit den Fahrer nicht von der Kontrolle der Funktionsfähigkeit der Beleuchtung.

Bei verschiedenen Zugfahrzeugen können zusätzliche nicht gesetzlich vorgeschriebene Lichtfunktionen kontrolliert werden, die zu Fehlerdiagnosen im Fahrzeuginneren führen können. Diese zusätzliche Kontrolle ist eine Komfortfunktion des Fahrzeugs und befreit den Fahrer nicht von der visuellen Kontrolle der Lichtfunktion. (z.B.: Instrumententafel im Fahrerhaus zeigt einen Lampenausfall an, obwohl die Funktion gegeben ist)

Der Betrieb der Leuchte mit Wechselspannung oder getakteter Gleichspannung ist nicht zulässig. Die einzelnen Funktionen der Leuchte dürfen nur mit einer fahrzeugseitigen Sicherung von max. 3A betrieben werden.

## General advice to the LCG!

LED lighting draws less current than Incandescent lamps. This is known to cause problems with certain Vehicle Bulb failure Monitoring systems, across all manufacturers.

The low power consumption of led lamps can lead to a visual error message to the driver. As monitoring of the direction indicator is a mandatory requirement, we recommend Aspöck Led lamps are always used in conjunction with our Led Control Gear „LCG“ Aspöck cannot accept any liability for incompatibility of the „LCG“ with the non-mandatory functions, these are provided for driver convenience. With the variation of vehicle types available it is impossible for Aspöck to verify every combination.

It is the Driver of the vehicles Legal responsibility to check all lighting is operating correctly. It must also be noted that the maximum current for each function is 3A. Please take care if connecting a Vehicle to an „AC source or pulsed DC“ as this will lead to component Failure.

No liability will be accepted for the use of „LCG“ with non-approved Vehicles or lamps. Aspöck Accepts no other terms and installation of our products will be deemed as full acceptance of our Terms and conditions.

VERBINDER / CONNECTORS

ÜBERSICHT / OVERVIEW

ASS1 & ASS2

13-5626-401			2 pol. weiblich 2 pin female
13-5625-991			2 pol. männlich 2 pin male
13-5626-631			7 pol. weiblich 7 pin female
13-5625-981			7 pol. männlich 7 pin male

ASS3

13-0322-281			3 pol. weiblich 3 pin female
13-0332-281			3 pol. männlich 3 pin male
13-1722-001			17 pol. weiblich 17 pin female
13-1732-001			17 pol. männlich 17 pin male

Bajonett | bayonet

13-0246-004			2 pol. weiblich 2 pin female
13-0236-004			2 pol. männlich 2 pin male
13-0521-104			5 pol. weiblich 5 pin female
13-0536-044			5 pol. männlich 5 pin male
13-0828-034			8 pol. weiblich 8 pin female
15-0821-524			8 pol. weiblich 8 pin female
13-0838-054			8 pol. männlich 8 pin male
13-1540-004			15 pol. weiblich 15 pin female
13-1530-004			15 pol. männlich 15 pin male

# VERBINDER / CONNECTORS

## ÜBERSICHT / OVERVIEW

### AMP

15-7002-004			4 pol. weiblich 4 pin female
15-7002-014			4 pol. männlich 4 pin male
15-7002-024			7 pol. weiblich 7 pin female
15-7002-034			7 pol. männlich 7 pin male

### Superseal

15-7002-044			2 pol. weiblich 2 pin female
15-7002-054			2 pol. männlich 2 pin male
15-7002-064			3 pol. weiblich 3 pin female
15-7002-074			3 pol. männlich 3 pin male
15-7002-084			4 pol. weiblich 4 pin female
15-7002-094			4 pol. männlich 4 pin male

### Deutsch

15-7002-135			2 pol. weiblich 2 pin female
15-7002-125			2 pol. männlich 2 pin male
15-7002-155			4 pol. weiblich 4 pin female
15-7002-145			4 pol. männlich 4 pin male

### ISO 1724/12098

13-3103-004			7 pol. männlich 7 pin male
13-3000-054			7 pol. weiblich 7 pin female
13-3170-004			15 pol. männlich 15 pin male
13-3070-004			15 pol. weiblich 15 pin female

**FASFPÖÖKX<sup>®</sup>**

**S Y S T E M S**

## ZUSÄTZLICHE INFORMATION

Zur einfachen Handhabung des Katalogs, finden Sie auf den abschließenden Seiten eine Übersicht produktbezogener Informationen inklusive der Artikelnummern und die Legende der verwendeten produktbeschreibenden Piktogramme in 10 Sprachen.

## ADDITIONAL INFORMATION

For easy handling of the catalog, on the final pages you will find an overview of product-related information including part numbers and – in 10 languages – the legend of the product-describing pictograms used.



# STANDARD-STECKPLAN FÜR KONTAKTBELEGUNG

Kontaktbelegung Contact assignment	Farbe (Abweichung durch div. Kabeltypen möglich)	DIN NR.	17 p. ASS3	15 p. ISO 12098	Baj.-Verb. 15 p.	Verteiler ASS1	7 p. ISO 1185	Baj.-Verb. 7 p. GRAU	ASS1/2 7 p. SCHWARZ	7 p. ISO 3731	Baj.-Verbinder 7 p. WEISS	ASS1/2 7 p. WEISS
Stromkreisfunktion Electrical circuit function	Colour (Deviation possible due to different cable types)	DIN NO.	17 pin ASS3	15 pin ISO 12098	Bayonet connector 15 pin	Distributor ASS1	7 pin ISO 1185	Bayonet connector 7 pin GREY	ASS1/2 7 pin BLACK	7 pin ISO 3731	Bayonet connector 7 pin white	ASS1/2 7 pin white
Blinker links Blinker left	GE YL	L	1		1			3			-	
Blinker rechts Blinker right	GN	R	2		2			5			-	
Nebelschlussleuchte Rear fog light	BL	"S"54g	3		3			-			7	
Masse Ground	WS WH	31	4		4			1			-	
Rücklicht links Tail light left	SW BL	58L	5		5			2			-	
Rücklicht rechts Tail light right	BR	58R	6		6			6			-	
Bremslicht Stop light	RT RD	54	7		7			4			-	
Rückfahrleuchte Reversing light	GR	"S"L	8		8			-			3	
Allgem. Stromver. (+) General power supply (+)	BR/BL	"S"54	9		9			-			4	
Verschleißanzeige Wear display	BR/RT BR/RD	-	10		10			-			-	
Federspeicheranzeige Spring-loaded display	GE/SW YL/BL	54g	11		11			7			-	
Achsanhebung Axle lift	RS	"S"58R	12		12			-			6	
Masse für Elektroniken Ground for electronic control units	WS/SW WH/BL	"S"31	13		13			-			1	
Datenleitung Data cable	VI	"S"58L	14		14			-			2	
Datenleitung Data cable	OR	"S"R	15		15			-			5	
Frei Free	VI/GN	-	16		-			-			-	
Frei Free	OR/BL	-	17		-			-			-	
Stromführung Live	div. Various	-	-		-			-			-	



## PLUG-IN DIAGRAMM FOR CONTACT ASSIGNMENT

Kontaktbelegung Contact assignment	Farbe (Abweichung durch div. Kabeltypen möglich)	DIN NR.	Baj.-Verb. 8 p. SW	ASS1/2 7 p. GE, GN	Baj.-Verbinder 5 p. SCHWARZ		Baj.-Verb. 2 p. SW, GE, GN	ASS1/2 2 p. SW, GE, GN	ISO 12098 13 p. 24V	ISO 1724 7 p.	ISO 11446 13 p. 12V	ASS3 3 p.
					Baj.-Verb. 5 p. GELB (links)	Baj.-Verb. 5 p. GRÜN (rechts)						
Stromkreisfunktion Electrical circuit function	Colour (Deviation possible due to different cable types)	DIN NO.	Bayonet connector 8 pin BL	ASS1/2 7 pin YL, GN	Bayonet connector 5 pin BLACK		Bayonet connector 2 pin BL, YL, GN	ASS1/2 2 pin BL, YL, GN	ISO 12098 13 pin 24V	ISO 1724 7 pin	ISO 11446 13 pin 12V	ASS3 3 pin
					Bayonet connector 5 pin YELLOW (left)	Bayonet connector 5 pin GREEN (right)						
Blinker links Blinker left	GE YL	L	1		BL	-	-		3	1	1	-
Blinker rechts Blinker right	GN	R	4		-	BL	-		5	4	4	-
Nebelschlussleuchte Rear fog light	BL	"S"54g	2		S	-	-		9	(2)	2	-
Masse Ground	WS WH	31	3		31	31	1		1	3	3	1
Rücklicht links Tail light left	SW BL	58L	7		UR	-	-		2	7	7	-
Rücklicht rechts Tail light right	BR	58R	5		-	UR	-		6	5	5	-
Bremslicht Stop light	RT RD	54	6		BR	BR	-		4	6	6	-
Rückfahrleuchte Reversing light	GR	"S"L	8		-	S	-		8	-	8	-
Allgem. Stromver. (+) General power supply (+)	BR/BL	"S"54	-		-	-	-		10	-	9	-
Verschleißanzeige Wear display	BR/RT BR/RD	-	-		-	-	-		-	-	10	-
Federspeicheranzeige Spring-loaded display	GE/SW YL/BL	54g	-		-	-	-		7	(2)	*	-
Achsanhebung Axle lift	RS	"S"58R	-		-	-	-		13	-	-	-
Masse für Elektroniken Ground for electronic control units	WS/SW WH/BL	"S"31	-		-	-	-		-	-	13	-
Datenleitung Data cable	VI	"S"58L	-		-	-	-		11	-	-	-
Datenleitung Data cable	OR	"S"R	-		-	-	-		12	-	-	-
Frei Free	VI/GN	-	-		-	-	-		-	-	-	-
Frei Free	OR/BL	-	-		-	-	-		-	-	-	-
Stromführung Live	div. Various	-	-		-	-	2		-	-	-	2/3

# E-NUMMERN ÜBERSICHT

## Heckleuchten / Glühbirne

3 Kammernleuchte	E9_5520
Earpoint I	E9_1057
Ecoflex	E9_1853
Ecopoint I	E9_5266
Ecopoint I mit Dreieck	E9_5266
Ecopoint II	E9_1853
Ecopoint II ohne Dreieck	E9_6246
Eurofab	E9_1211
Europoint III	E9_6984 E9_6985
Europoint II	E9_5497 E13_1787
Europoint I	E9_5167 E2_7078

## Heckleuchten / LED

3 Kammernleuchte LED	E9_6556 E9_1139 E4_23271 E9_5595 E9_1490 E4_13992 E4_4052
AgriLED I	E9_1016
AgriLED II	E9_1121
Agripoint LED	E9_11549
Braspoint 98	E9_11417 E9_11875 E9_11874 E9_11873 E9_11418 E9_11419
Braspoint 140	E9_11412 E9_11416 E9_11876 E9_11887
EcoLED	E9_1854
EcoLED II	E9_16286 E9_22480
EcoLED III	E9_1928
Ecopoint I LED	E9_5266
Ecopoint II LED	E9_11865 E24_1804
Ecopoint II LED ohne Dreieck	E9_11866
Europoint III LED	E9_11093 E9_11094
Europoint II LED	E9_5497
MidiLED I	E9_1637
MidiLED I Max	E9_23554
MiniLED II	E9_6535 E9_6532 E9_6530 E9_6531
MiniLED III	E9_6054
MultiLED	E9_1599 E9_1600
MultiLED II	E24_6110

MultiLED III mit Dreieck	E9_22128 E9_23441
MultiLED III ohne Dreieck	E9_22128 E9_23442
Multipoint LED	E9_5186
Multipoint V LED	E9_5946
MultiLED IV	E9_1364
Linepoint I	E24_0145 E24_6109
Linepoint II	E9_11442 E9_11443
Posipoint IV	E24_6144 E24_6145 E24_6146

## Positionsluchte / Glühbirne

Flexipoint I rot	E9_5332
Flexipoint I weiß	E9_5332
Monopoint	E4_7740
Sidepoint weiß	E13_0484 E13_9592

## Positionsluchte / LED

Flatpoint I weiß LED	E24_6094
Flatpoint II rot LED	E9_5499
Flatpoint II weiß LED	E9_5499
Monopoint II rot LED	E9_5594
Monopoint II weiß LED	E9_5594
Posipoint II weiß LED	E9_5593
Posipoint II rot LED	E9_5593
Unipoint I rot LED	E9_5409
Unipoint I weiß LED	E9_5409

## Seitenmarkierungsleuchte / Glühbirne

Sidepoint	E13_9592
-----------	----------

## Seitenmarkierungsleuchte / LED

Flatpoint I LED	E24_6094
Flatpoint II LED	E9_5499
Unipoint I LED	E9_5409

## Umrissleuchte / Glühbirne

Flexipoint I rot / weiß	E9_5532
Superpoint I	E13_0339 E13_2317
Superpoint II	E9_5315

## Umrissleuchte / LED

Flexipoint II LED	E24_0151
Superpoint III LED	E9_1469
Superpoint IV LED	E9_6878

## Kennzeichenleuchte / Glühbirne

Regpoint	E9_4127 E9_4135
Regpoint rot	E9_4059 E9_4127
Regpoint small	E20_9944

## Kennzeichenleuchte / LED

Kennzeichenhalter inkl. 2 x KZL LED	E9_1558
Kennzeichenhalter FlexLED	E24_0004
Regpoint LED	E9_4133
Regpoint II LED	E4_4352

## Dritte Bremsleuchte

Dritte Bremsleuchte	E9_4075
Dritte Bremsleuchten LED mit KZ-Halter	E9_4075

## Arbeits- Rückfahrscheinwerfer

Arbeitsscheinwerfer / Rückfahrscheinwerfer	E9_4013 E9_1014
Rückfahrscheinwerfer LED oval	E9_6989
Workpoint LED 650	E13_12435
Workpoint LED 800	E13_12438
Workpoint LED 1000	E24_0005
Workpoint LED 1500	E9_1228
Workpoint LED 3000	E9_1393
Workpoint II 1000	E24_0005
Workpoint II 1500	E24_0002
Workpoint II 3000	E24_0002

## Innenleuchte

Innenleuchte LED rund	E24_0976
Inpoint III LED ohne Schalter	E9_1439 E9_1440
Inpoint III LED mit Schalter	E9_1439 E9_1440
Inpoint III LED mit Bewegungssensor	E9_1439 E9_1440
LED-Innenleuchte	E24_0976
Tubeipoint	E24_2384

# APPROVAL NUMBER OVERVIEW

ZUBEHÖR / ACCESSORIES

## Rear Lamps / bulb

3 Kammernleuchte	E9_5520
Earpoint I	E9_1057
Ecoflex	E9_1853
Ecopoint I	E9_5266
Ecopoint I mit Dreieck	E9_5266
Ecopoint II	E9_1853
Ecopoint II ohne Dreieck	E9_6246
Eurofab	E9_1211
Europoint III	E9_6984 E9_6985
Europoint II	E9_5497 E13_1787
Europoint I	E9_5167 E2_7078

## Rear Lamps / LED

3 chamber lamp LED	E9_6556 E9_1139 E4_23271 E9_5595 E9_1490 E4_13992 E4_4052
AgriLED I	E9_1016
AgriLED II	E9_1121
Agripoint LED	E9_11549
Braspoint 98	E9_11417 E9_11875 E9_11874 E9_11873 E9_11418 E9_11419
Braspoint 140	E9_11412 E9_11416 E9_11876 E9_11887
EcoLED	E9_1854
EcoLED II	E9_16286 E9_22480
EcoLED III	E9_1928
Ecopoint I LED	E9_5266
Ecopoint II LED	E9_11865 E24_1804
Ecopoint II LED without triangle	E9_11866
Europoint III LED	E9_11093 E9_11094
Europoint II LED	E9_5497
MidiLED I	E9_1637
MidiLED I Max	E9_23554
MiniLED II	E9_6535 E9_6532 E9_6530 E9_6531
MiniLED III	E9_6054
MultiLED	E9_1599 E9_1600
MultiLED II	E24_6110

MultiLED III with triangle	E9_22128 E9_23441
MultiLED III without triangle	E9_22128 E9_23442
Multipoint LED	E9_5186
Multipoint V LED	E9_5946
MultiLED IV	E9_1364
Linepoint I	E24_0145 E24_6109
Linepoint II	E9_11442 E9_11443
Posipoint IV	E24_6144 E24_6145 E24_6146

## Position Lamps / bulb

Flexipoint I red	E9_5332
Flexipoint I white	E9_5332
Monopoint	E4_7740
Sidepoint white	E13_0484 E13_9592

## Position Lamps / LED

Flatpoint I white LED	E24_6094
Flatpoint II red LED	E9_5499
Flatpoint II white LED	E9_5499
Monopoint II red LED	E9_5594
Monopoint II white LED	E9_5594
Posipoint II white LED	E9_5593
Posipoint II red LED	E9_5593
Unipoint I red LED	E9_5409
Unipoint I white LED	E9_5409

## Side Marker Lamps / bulb

Sidepoint	E13_9592
-----------	----------

## Side Marker Lamps / LED

Flatpoint I LED	E24_6094
Flatpoint II LED	E9_5499
Unipoint I LED	E9_5409

## End Outline Marker Lamps / bulb

Flexipoint I red / white	E9_5532
Superpoint I	E13_0339 E13_2317
Superpoint II	E9_5315

## End outline marker lamps / LED

Flexipoint II LED	E24_0151
Superpoint III LED	E9_1469
Superpoint IV LED	E9_6878

## Number Plate Lamps / LED

Regpoint	E9_4127 E9_4135
Regpoint red	E9_4059 E9_4127
Regpoint small	E20_9944

## Number Plate Lamps / LED

Number plate pad include 2 x NPL LED	E9_1558
Number plate holder FlexLED	E24_0004
Regpoint LED	E9_4133
Regpoint II LED	E4_4352

## Additional Lamps

Third stop lamp	E9_4075
Third stop lamp „LED“ with Registration Plate	E9_4075

## Revers and Working Lamps

Reverse-working lamp	E9_4013 E9_1014
Reversing lamp LED oval	E9_6989
Workpoint LED 650	E13_12435
Workpoint LED 800	E13_12438
Workpoint LED 1000	E24_0005
Workpoint LED 1500	E9_1228
Workpoint LED 3000	E9_1393
Workpoint II 1000	E24_0005
Workpoint II 1500	E24_0002
Workpoint II 3000	E24_0002

## Interior Lamps

Interior Lamp LED round	E24_0976
Inpoint III LED without switch	E9_1439 E9_1440
Inpoint III LED with switch	E9_1439 E9_1440
Inpoint III LED with motion sensor	E9_1439 E9_1440
LED-Interior lamp	E24_0976
Tubeptoint	E24_2384

## BESTELLNUMMERN / PART NUMBERS

ARTIKEL NR PART NO	SEITE PAGE	ARTIKEL NR PART NO	SEITE PAGE	ARTIKEL NR PART NO	SEITE PAGE	ARTIKEL NR PART NO	SEITE PAGE	ARTIKEL NR PART NO	SEITE PAGE	ARTIKEL NR PART NO	SEITE PAGE
11-2128-194	137	13-0322-281	207	13-1722-001	46	13-5626-401	199	15-5270-004	28	15-5623-304	19
12-1522-004	45	13-0322-281	244	13-1722-001	244	13-5626-401	201	15-5270-004	33	15-5623-304	21
12-1522-014	45	13-0332-281	78	13-1732-001	46	13-5626-401	244	15-5270-004	36	15-5623-304	28
12-1522-024	45	13-0332-281	80	13-1732-001	244	13-5626-631	15	15-5270-004	45	15-5623-304	34
12-1522-034	45	13-0332-281	82	13-3000-054	245	13-5626-631	19	15-5270-004	48	15-5623-304	42
12-1522-144	41	13-0332-281	114	13-3070-004	245	13-5626-631	21	15-5272-004	240	15-5623-304	66
12-1522-154	41	13-0332-281	118	13-3103-004	245	13-5626-631	28	15-5272-014	240	15-5623-304	72
12-1526-004	45	13-0332-281	121	13-3170-004	245	13-5626-631	34	15-5276-001	28	15-5624-014	143
12-1526-014	45	13-0332-281	132	13-3424-184	237	13-5626-631	36	15-5276-001	33	15-5624-024	143
12-1526-024	45	13-0332-281	137	13-5625-981	15	13-5626-631	42	15-5276-001	36	15-5729-014	114
12-1526-034	45	13-0332-281	143	13-5625-981	57	13-5626-631	46	15-5276-001	45	15-5729-014	118
12-1526-144	41	13-0332-281	147	13-5625-981	59	13-5626-631	48	15-5276-001	48	15-5729-014	121
12-1526-154	41	13-0332-281	149	13-5625-981	70	13-5626-631	50	15-5277-004	21	15-5729-014	125
12-1526-164	41	13-0332-281	156	13-5625-981	74	13-5626-631	57	15-5280-154	212	15-5729-014	127
12-1527-004	76	13-0332-281	161	13-5625-981	76	13-5626-631	59	15-5300-294	15	15-5729-014	132
12-1528-001	41	13-0332-281	163	13-5625-981	78	13-5626-631	61	15-5300-294	19	15-5729-014	137
12-1528-001	50	13-0332-281	169	13-5625-981	87	13-5626-631	66	15-5300-424	167	15-5729-014	143
12-1529-001	41	13-0332-281	171	13-5625-981	89	13-5626-631	70	15-5303-004	59	15-5729-014	147
12-1529-001	50	13-0332-281	173	13-5625-981	94	13-5626-631	72	15-5310-104	125	15-5729-014	151
12-1530-004	74	13-0332-281	187	13-5625-981	99	13-5626-631	74	15-5310-104	127	15-5729-014	156
12-1531-004	74	13-0332-281	190	13-5625-981	244	13-5626-631	76	15-5311-004	125	15-5729-014	158
12-1560-001	33	13-0332-281	207	13-5625-991	94	13-5626-631	78	15-5311-004	127	15-5729-014	161
12-1560-011	33	13-0332-281	244	13-5625-991	99	13-5626-631	87	15-5312-104	125	15-5729-014	169
12-1560-021	33	13-0521-104	55	13-5625-991	114	13-5626-631	89	15-5312-104	127	15-5729-014	171
12-1560-031	33	13-0521-104	59	13-5625-991	118	13-5626-631	94	15-5313-004	121	15-5729-014	175
12-1560-141	33	13-0521-104	63	13-5625-991	121	13-5626-631	99	15-5313-004	114	15-5729-014	177
12-1570-001	27	13-0521-104	70	13-5625-991	136	13-5626-631	103	15-5314-104	125	15-5729-014	191
12-1570-101	27	13-0521-104	84	13-5625-991	143	13-5626-631	244	15-5314-104	127	15-5729-014	206
12-1570-204	27	13-0521-104	87	13-5625-991	156	14-0418-304	133	15-5316-004	125	15-5729-014	209
12-1570-214	27	13-0521-104	89	13-5625-991	163	14-1430-454	33	15-5316-004	127	15-5729-014	149
12-1570-224	27	13-0521-104	94	13-5625-991	169	14-1430-454	53	15-5316-704	125	15-5729-014	163
12-1570-234	27	13-0521-104	101	13-5625-991	171	14-1430-554	27	15-5316-704	127	15-5729-014	173
12-1574-204	27	13-0521-104	103	13-5625-991	173	14-1964-004	240	15-5317-004	144	15-5729-014	207
12-1574-214	27	13-0521-104	105	13-5625-991	177	14-4302-224	188	15-5317-004	147	15-5971-014	114
12-1574-224	27	13-0521-104	107	13-5625-991	181	14-4596-004	144	15-5317-004	149	15-5971-014	118
12-1574-234	27	13-0521-104	244	13-5625-991	187	14-4596-004	147	15-5317-004	151	15-5971-014	121
12-3922-004	27	13-0536-044	55	13-5625-991	190	14-4596-004	149	15-5317-014	144	15-5971-014	125
12-3922-004	33	13-0536-044	59	13-5625-991	193	14-4596-004	151	15-5317-014	147	15-5971-014	127
12-3922-004	36	13-0536-044	63	13-5625-991	195	15-0821-524	59	15-5317-014	149	15-5971-014	132
12-3922-004	41	13-0536-044	70	13-5625-991	197	15-0821-524	70	15-5317-014	151	15-5971-014	143
12-3922-004	233	13-0536-044	84	13-5625-991	199	15-0821-524	76	15-5317-024	144	15-5971-014	147
12-3922-014	233	13-0536-044	87	13-5625-991	201	15-0821-524	87	15-5317-024	147	15-5971-014	149
12-3970-584	27	13-0536-044	89	13-5625-991	244	15-0821-524	89	15-5317-024	149	15-5971-014	151
12-3970-584	33	13-0536-044	94	13-5626-401	19	15-0821-524	94	15-5317-024	151	15-5971-014	154
12-3970-584	41	13-0536-044	101	13-5626-401	21	15-0821-524	244	15-5318-004	125	15-5971-014	158
12-6830-094	28	13-0536-044	105	13-5626-401	28	15-2122-104	136	15-5318-004	127	15-5971-014	161
12-6830-094	34	13-0536-044	107	13-5626-401	34	15-2122-124	136	15-5319-004	144	15-5971-014	163
13-0236-004	244	13-0536-044	244	13-5626-401	42	15-2122-164	137	15-5319-004	147	15-5971-014	169
13-0246-004	244	13-0821-524	63	13-5626-401	66	15-2122-164	154	15-5319-004	149	15-5971-014	171
13-0320-004	78	13-0828-034	59	13-5626-401	72	15-2122-174	137	15-5319-004	151	15-5971-014	175
13-0322-281	78	13-0828-034	63	13-5626-401	94	15-2122-174	154	15-5319-304	144	15-5971-014	177
13-0322-281	80	13-0828-034	70	13-5626-401	99	15-2128-094	137	15-5319-304	147	15-5971-014	191
13-0322-281	82	13-0828-034	76	13-5626-401	114	15-2128-144	137	15-5319-304	149	15-5971-014	206
13-0322-281	114	13-0828-034	87	13-5626-401	118	15-2128-144	154	15-5319-304	151	15-5971-014	209
13-0322-281	118	13-0828-034	89	13-5626-401	121	15-2128-214	133	15-5319-904	143	15-5971-014	137
13-0322-281	121	13-0828-034	94	13-5626-401	136	15-2128-274	137	15-5321-004	133	15-5971-014	156
13-0322-281	132	13-0828-034	95	13-5626-401	143	15-2128-274	154	15-5321-104	133	15-5971-014	173
13-0322-281	136	13-0828-034	99	13-5626-401	156	15-2128-285	144	15-5321-204	133	15-5971-014	207
13-0322-281	143	13-0828-034	244	13-5626-401	163	15-2128-285	147	15-5321-234	133	15-5976-034	123
13-0322-281	147	13-0838-054	59	13-5626-401	169	15-2128-285	149	15-5321-404	133	15-5983-024	114
13-0322-281	149	13-0838-054	63	13-5626-401	171	15-2128-285	151	15-5322-004	133	15-5983-024	118
13-0322-281	156	13-0838-054	70	13-5626-401	173	15-2128-514	154	15-5322-004	144	15-5983-024	121
13-0322-281	161	13-0838-054	76	13-5626-401	177	15-2128-524	154	15-5322-004	147	15-5983-024	125
13-0322-281	163	13-0838-054	87	13-5626-401	181	15-2128-544	121	15-5322-004	149	15-5983-024	127
13-0322-281	169	13-0838-054	89	13-5626-401	187	15-5020-824	204	15-5322-004	151	15-5983-024	132
13-0322-281	171	13-0838-054	94	13-5626-401	190	15-5111-004	133	15-5323-004	50	15-5983-024	137
13-0322-281	173	13-0838-054	244	13-5626-401	193	15-5111-404	82	15-5325-004	118	15-5983-024	143
13-0322-281	187	13-1530-004	244	13-5626-401	195	15-5113-004	156	15-5325-101	118	15-5983-024	147
13-0322-281	190	13-1540-004	244	13-5626-401	197	15-5203-004	181	15-5609-104	156	15-5983-024	149

# BESTELLNUMMERN / PART NUMBERS

ARTIKEL NR PART NO	SEITE PAGE	ARTIKEL NR PART NO	SEITE PAGE	ARTIKEL NR PART NO	SEITE PAGE	ARTIKEL NR PART NO	SEITE PAGE	ARTIKEL NR PART NO	SEITE PAGE	ARTIKEL NR PART NO	SEITE PAGE
15-5983-024	151	15-7002-054	82	18-8458-131	76	21-7800-004	145	24-8930-051	64	25-2911-551	40
15-5983-024	156	15-7002-054	94	18-8485-004	74	21-8004-011	208	24-8930-061	64	25-2920-501	40
15-5983-024	158	15-7002-054	99	18-8487-004	74	21-8004-041	208	24-8930-071	65	25-2920-541	40
15-5983-024	161	15-7002-054	114	18-8520-002	48	21-8007-144	209	24-8930-081	65	25-2920-741	40
15-5983-024	163	15-7002-054	118	18-8522-002	45	21-8007-154	209	24-8931-001	64	25-2931-501	40
15-5983-024	169	15-7002-054	121	18-8526-002	41	21-8007-164	209	24-8931-011	64	25-2932-501	40
15-5983-024	171	15-7002-054	139	18-8527-002	41	22-7000-001	94	24-8931-021	64	25-2960-001	38
15-5983-024	175	15-7002-054	161	18-8528-002	41	22-7000-701	92	24-8931-031	64	25-2960-041	38
15-5983-024	177	15-7002-054	169	18-8528-402	50	22-7000-001	91	24-8931-041	64	25-2960-701	38
15-5983-024	191	15-7002-054	171	18-8529-002	41	23-4000-001	104	24-8931-051	64	25-2960-701	38
15-5983-024	206	15-7002-054	173	18-8529-402	50	23-4000-031	104	24-8931-061	64	25-2970-401	40
15-5983-024	207	15-7002-054	187	18-8536-001	19	23-4000-501	104	24-8931-071	65	25-2980-521	38
15-5983-024	209	15-7002-054	190	18-8536-011	19	23-4000-531	104	24-8931-081	65	25-2980-531	40
15-5983-024	173	15-7002-054	195	18-8550-002	36	23-4004-001	104	24-8937-001	66	25-3800-501	20
15-7002-004	87	15-7002-054	197	18-8560-002	33	23-4004-031	104	24-8937-011	66	25-3800-511	20
15-7002-004	89	15-7002-054	199	18-8570-001	27	23-4004-501	104	25-2000-501	47	25-3820-511	20
15-7002-004	245	15-7002-054	201	18-8570-011	27	23-4004-531	104	25-2200-001	43	25-3900-501	20
15-7002-014	87	15-7002-054	245	18-8570-101	27	23-4124-021	100	25-2200-701	43	25-3900-511	20
15-7002-014	89	15-7002-064	82	18-8570-111	27	23-4124-031	100	25-2201-001	43	25-3920-511	20
15-7002-014	245	15-7002-064	94	18-8580-001	53	23-4124-061	100	25-2210-001	44	25-4120-001	17
15-7002-024	15	15-7002-064	245	18-8630-104	173	23-4124-071	100	25-2210-701	44	25-4120-011	17
15-7002-024	19	15-7002-074	82	18-8630-104	175	23-4124-211	102	25-2211-001	44	25-4120-021	17
15-7002-024	28	15-7002-074	94	18-8780-104	99	23-4124-231	102	25-2400-501	47	25-4120-031	17
15-7002-024	34	15-7002-074	245	18-8784-501	94	23-8200-011	96	25-2600-001	43	25-4120-041	17
15-7002-024	42	15-7002-084	237	18-8880-104	99	23-8200-511	96	25-2600-701	43	25-4120-051	17
15-7002-024	53	15-7002-084	245	18-8884-501	94	23-8220-001	96	25-2601-001	43	25-4120-061	18
15-7002-024	57	15-7002-094	245	21-2000-014	145	23-8230-001	96	25-2610-001	44	25-4121-001	17
15-7002-024	66	15-7002-125	171	21-2000-024	145	23-8400-711	95	25-2610-701	44	25-4121-011	17
15-7002-024	70	15-7002-125	187	21-2000-035	145	23-8400-721	95	25-2611-001	44	25-4121-021	17
15-7002-024	72	15-7002-125	191	21-2000-054	145	23-8400-751	92	25-2800-001	37	25-4121-031	17
15-7002-024	74	15-7002-125	197	21-2000-064	145	23-8400-761	92	25-2800-401	49	25-4121-041	17
15-7002-024	87	15-7002-125	199	21-2000-104	145	23-8400-771	92	25-2800-451	37	25-4121-051	17
15-7002-024	89	15-7002-125	201	21-2000-144	145	23-8400-781	92	25-2800-501	37	25-4121-061	18
15-7002-024	94	15-7002-125	245	21-2000-154	145	23-8400-801	92	25-2800-511	37	25-4122-011	14
15-7002-024	99	15-7002-135	171	21-2002-004	145	23-8400-811	92	25-2800-521	37	25-4122-021	14
15-7002-024	245	15-7002-135	187	21-2200-014	136	23-8400-821	92	25-2801-501	37	25-4122-031	14
15-7002-034	15	15-7002-135	191	21-2201-004	136	23-8500-701	95	25-2801-701	37	25-4122-041	14
15-7002-034	57	15-7002-135	197	21-2201-014	136	23-8500-721	95	25-2810-401	49	25-4122-051	14
15-7002-034	70	15-7002-135	199	21-2201-044	136	24-3814-001	54	25-2810-451	39	25-4122-061	14
15-7002-034	74	15-7002-135	201	21-2202-004	136	24-3814-011	54	25-2810-501	39	25-4123-011	14
15-7002-034	87	15-7002-135	245	21-2302-004	132	24-4101-001	60	25-2810-511	39	25-4123-021	14
15-7002-034	89	15-7002-145	84	21-2303-004	132	24-4105-001	60	25-2811-501	39	25-4123-031	14
15-7002-034	94	15-7002-145	245	21-2800-014	153	24-4111-001	60	25-2820-501	39	25-4123-041	14
15-7002-034	99	15-7002-155	245	21-2801-004	153	24-4151-001	60	25-2820-541	39	25-4123-051	14
15-7002-034	245	15-7203-004	240	21-2801-054	153	24-4301-001	60	25-2820-741	39	25-4123-061	14
15-7002-044	19	16-6110-017	53	21-2801-064	153	24-4305-001	60	25-2831-501	39	25-4126-001	17
15-7002-044	28	16-6121-017	53	21-3300-007	118	24-4311-001	60	25-2832-501	39	25-4126-011	17
15-7002-044	34	16-6121-017	91	21-3302-007	118	24-4351-001	60	25-2860-001	37	25-4126-031	17
15-7002-044	42	16-6122-017	91	21-3350-704	118	24-5700-721	75	25-2860-041	37	25-4126-041	17
15-7002-044	66	16-6305-027	36	21-3351-704	118	24-5800-731	75	25-2860-701	37	25-4126-061	17
15-7002-044	82	16-6305-027	46	21-3353-704	118	24-5805-711	75	25-2860-701	37	25-5000-501	35
15-7002-044	94	16-6305-027	48	21-3354-704	118	24-5813-701	75	25-2870-401	39	25-5001-501	35
15-7002-044	99	16-6456-001	201	21-3800-004	61	24-7400-701	71	25-2880-521	37	25-5100-501	35
15-7002-044	114	18-8136-004	46	21-5000-004	153	24-7430-701	71	25-2880-531	39	25-5400-501	35
15-7002-044	118	18-8136-004	61	21-5000-034	153	24-7470-701	71	25-2900-001	38	25-5401-501	35
15-7002-044	121	18-8136-004	121	21-5000-054	153	24-7500-701	71	25-2900-401	49	25-5500-501	35
15-7002-044	139	18-8141-004	33	21-6510-004	127	24-7530-701	71	25-2900-451	38	25-6000-501	29
15-7002-044	161	18-8141-004	42	21-6512-004	127	24-7570-701	71	25-2900-501	38	25-6000-701	29
15-7002-044	169	18-8141-004	51	21-6513-004	127	24-7630-701	71	25-2900-511	38	25-6000-711	29
15-7002-044	171	18-8382-104	99	21-6513-214	127	24-7730-701	71	25-2900-521	38	25-6000-721	29
15-7002-044	173	18-8384-501	94	21-6600-004	136	24-8502-001	73	25-2901-501	38	25-6000-741	29
15-7002-044	187	18-8384-551	94	21-6601-004	136	24-8504-701	73	25-2901-551	38	25-6000-751	29
15-7002-044	190	18-8440-001	61	21-7600-001	91	24-8702-001	73	25-2901-701	38	25-6001-501	29
15-7002-044	195	18-8440-051	61	21-7700-004	144	24-8714-701	73	25-2910-401	49	25-6010-501	29
15-7002-044	197	18-8442-001	61	21-7700-014	144	24-8930-001	64	25-2910-451	40	25-6010-541	29
15-7002-044	199	18-8442-101	61	21-7700-024	144	24-8930-011	64	25-2910-501	40	25-6011-501	29
15-7002-044	201	18-8457-051	76	21-7700-035	144	24-8930-021	64	25-2910-511	40	25-6011-511	31
15-7002-044	237	18-8457-131	76	21-7700-054	144	24-8930-031	64	25-2910-551	40	25-6011-701	31
15-7002-044	245	18-8458-051	76	21-7702-014	144	24-8930-041	64	25-2911-501	40	25-6015-501	31

## BESTELLNUMMERN / PART NUMBERS

ARTIKEL NR PART NO	SEITE PAGE	ARTIKEL NR PART NO	SEITE PAGE	ARTIKEL NR PART NO	SEITE PAGE	ARTIKEL NR PART NO	SEITE PAGE	ARTIKEL NR PART NO	SEITE PAGE	ARTIKEL NR PART NO	SEITE PAGE
25-6020-751	31	25-7400-721	23	31-2064-034	140	31-2864-034	152	31-3106-044	111	31-3363-004	116
25-6021-701	31	25-7400-741	23	31-2064-124	140	31-3100-004	110	31-3164-004	111	31-3363-104	116
25-6030-501	29	25-7400-751	26	31-2064-214	140	31-3102-024	28	31-3164-014	111	31-3364-004	117
25-6030-701	29	25-7400-761	23	31-2064-234	141	31-3102-024	110	31-3165-004	111	31-3364-024	116
25-6030-711	29	25-7401-531	23	31-2064-414	141	31-3102-034	110	31-3166-004	111	31-3364-054	116
25-6030-721	29	25-7401-601	23	31-2064-434	141	31-3102-044	113	31-3300-074	115	31-3365-014	116
25-6101-501	29	25-7401-611	23	31-2064-714	141	31-3102-054	113	31-3300-244	117	31-3365-054	116
25-6110-501	31	25-7402-001	23	31-2064-734	141	31-3102-064	112	31-3300-374	117	31-3365-064	116
25-6110-711	31	25-7402-101	25	31-2064-774	141	31-3102-074	112	31-3302-024	42	31-3365-094	115
25-6200-501	29	25-7420-501	25	31-2067-084	141	31-3102-104	111	31-3302-024	50	31-3366-024	116
25-6210-501	31	25-7420-511	25	31-2067-094	141	31-3102-114	111	31-3302-034	42	31-3366-054	116
25-6211-501	31	25-7420-541	25	31-2067-104	141	31-3102-124	111	31-3302-034	50	31-3366-064	116
25-6400-501	30	25-7420-551	25	31-2067-694	141	31-3102-134	112	31-3302-044	42	31-3366-094	115
25-6400-701	30	25-7420-701	25	31-2100-034	148	31-3102-144	112	31-3302-044	51	31-3367-004	117
25-6400-711	30	25-7420-711	25	31-2100-134	146	31-3102-154	112	31-3302-054	115	31-3404-004	119
25-6400-721	30	25-7420-721	25	31-2104-014	141	31-3102-164	113	31-3302-064	117	31-3404-014	119
25-6400-741	30	25-7420-741	25	31-2104-034	141	31-3102-184	111	31-3302-104	42	31-3404-064	119
25-6400-751	30	25-7420-751	25	31-2104-064	150	31-3102-194	112	31-3302-104	51	31-3404-104	119
25-6401-501	30	25-7420-761	25	31-2104-074	146	31-3102-204	15	31-3303-024	42	31-3404-114	119
25-6410-501	30	25-7420-771	25	31-2107-004	146	31-3102-204	19	31-3303-024	50	31-3404-124	119
25-6411-501	30	25-7421-521	25	31-2107-014	148	31-3102-204	111	31-3303-034	42	31-3404-134	119
25-6411-511	32	25-7421-531	25	31-2107-024	148	31-3102-214	15	31-3303-034	50	31-3404-364	119
25-6415-501	32	25-7430-711	23	31-2164-014	141	31-3102-214	19	31-3303-044	42	31-3405-004	119
25-6420-751	32	25-7430-721	23	31-2164-034	141	31-3102-214	111	31-3303-044	51	31-3405-074	119
25-6421-701	32	25-7537-154	19	31-2204-014	135	31-3103-024	28	31-3303-054	115	31-3406-004	119
25-6430-701	30	25-7537-154	28	31-2204-154	137	31-3103-024	110	31-3303-064	117	31-3406-064	119
25-6430-711	30	25-8100-001	52	31-2214-004	135	31-3103-034	110	31-3303-104	42	31-3407-104	119
25-6430-721	30	25-8100-161	52	31-2214-014	135	31-3103-044	113	31-3303-104	51	31-3407-114	119
25-6501-501	30	25-8100-201	52	31-2214-024	135	31-3103-054	113	31-3304-044	115	31-3604-044	120
25-6501-511	30	25-8100-501	52	31-2214-034	135	31-3103-064	112	31-3304-054	115	31-3604-054	120
25-6510-501	32	25-8300-001	52	31-2214-114	135	31-3103-074	112	31-3304-094	117	31-3605-004	120
25-6510-711	32	25-8300-161	52	31-2214-134	135	31-3103-104	110	31-3304-114	115	31-3606-004	120
25-6600-501	30	25-8300-201	52	31-2264-014	135	31-3103-114	110	31-3304-124	115	31-3608-004	46
25-6601-511	30	25-8300-501	52	31-2264-024	135	31-3103-124	110	31-3304-134	115	31-3608-004	120
25-6610-501	32	26-1200-004	176	31-2264-034	135	31-3103-134	112	31-3304-144	115	31-3608-014	46
25-7000-501	22	26-3000-004	173	31-2267-014	135	31-3103-144	112	31-3305-014	115	31-3608-014	120
25-7000-511	22	26-3010-004	175	31-2267-064	135	31-3103-154	112	31-3305-044	115	31-3704-004	119
25-7000-541	26	27-7600-001	91	31-2267-074	135	31-3103-164	113	31-3305-044	231	31-3704-014	119
25-7000-701	22	27-8000-021	96	31-2267-084	135	31-3103-184	110	31-3305-064	33	31-3707-024	119
25-7000-711	22	27-8001-511	96	31-2304-014	130	31-3103-194	112	31-3305-084	34	31-3707-095	120
25-7000-721	22	27-8100-701	95	31-2304-034	130	31-3103-204	15	31-3305-084	116	31-3707-105	119
25-7000-741	22	27-8100-721	92	31-2304-044	130	31-3103-204	19	31-3305-124	115	31-3707-134	120
25-7000-751	22	27-8400-701	92	31-2304-094	130	31-3103-204	110	31-3305-174	46	31-3707-144	120
25-7000-761	26	28-7600-001	91	31-2304-104	130	31-3103-214	15	31-3305-194	117	31-3792-004	120
25-7001-501	22	28-8000-021	96	31-2307-004	130	31-3103-214	19	31-3305-214	115	31-3793-004	120
25-7001-601	22	28-8001-521	96	31-2307-014	130	31-3103-214	110	31-3305-234	21	31-3804-004	120
25-7001-611	22	28-8100-711	95	31-2364-014	130	31-3104-004	110	31-3305-294	115	31-3804-014	120
25-7002-001	22	28-8100-731	92	31-2364-034	130	31-3104-014	110	31-3306-014	115	31-3805-004	120
25-7002-101	24	28-8400-701	92	31-2364-084	130	31-3104-024	111	31-3306-044	116	31-3805-024	120
25-7008-024	28	28-8524-001	185	31-2364-104	130	31-3104-034	110	31-3306-044	231	31-3806-004	120
25-7008-024	242	28-8524-011	184	31-2364-114	130	31-3104-044	112	31-3306-084	34	31-3806-024	120
25-7020-501	24	28-8524-031	186	31-2364-184	130	31-3104-054	112	31-3306-084	116	31-5004-014	152
25-7020-511	24	28-8524-041	186	31-2364-304	130	31-3104-064	113	31-3306-124	116	31-5004-094	152
25-7020-541	24	28-9100-001	200	31-2364-324	131	31-3104-074	113	31-3306-174	46	31-5004-104	152
25-7020-701	24	29-8410-101	206	31-2364-334	131	31-3104-084	112	31-3306-194	117	31-5004-154	152
25-7020-711	24	31-2000-014	140	31-2364-344	131	31-3104-094	112	31-3306-214	116	31-6004-074	157
25-7020-721	24	31-2000-034	140	31-2364-354	131	31-3104-104	113	31-3306-234	21	31-6204-084	157
25-7020-731	24	31-2004-014	140	31-2367-034	131	31-3104-114	113	31-3306-294	116	31-6300-004	124
25-7020-741	24	31-2004-034	140	31-2367-054	131	31-3104-124	113	31-3307-014	117	31-6304-014	124
25-7020-751	24	31-2004-044	140	31-2367-064	131	31-3104-134	113	31-3307-024	117	31-6364-004	124
25-7021-511	24	31-2004-074	140	31-2464-024	138	31-3105-004	110	31-3307-044	117	31-6364-014	124
25-7021-521	24	31-2007-024	140	31-2464-034	138	31-3105-014	110	31-3307-084	238	31-6404-014	131
25-7030-711	22	31-2007-234	140	31-2800-004	121	31-3105-024	111	31-3307-104	117	31-6404-094	131
25-7030-721	22	31-2007-244	140	31-2804-094	152	31-3105-034	111	31-3307-134	117	31-6404-124	131
25-7400-501	23	31-2007-294	140	31-2804-174	152	31-3105-044	111	31-3307-194	117	31-6504-084	126
25-7400-511	23	31-2007-304	140	31-2804-204	154	31-3106-004	110	31-3307-224	117	31-6504-104	126
25-7400-541	26	31-2007-334	140	31-2814-004	152	31-3106-014	111	31-3360-004	117	31-6504-134	126
25-7400-701	23	31-2007-344	140	31-2814-024	152	31-3106-024	111	31-3362-004	116	31-6504-174	126
25-7400-711	23	31-2064-014	140	31-2864-004	152	31-3106-034	111	31-3362-104	116	31-6564-064	126

# BESTELLNUMMERN / PART NUMBERS

ARTIKEL NR PART NO	SEITE PAGE	ARTIKEL NR PART NO	SEITE PAGE	ARTIKEL NR PART NO	SEITE PAGE	ARTIKEL NR PART NO	SEITE PAGE	ARTIKEL NR PART NO	SEITE PAGE	ARTIKEL NR PART NO	SEITE PAGE
31-6564-074	126	31-7400-004	160	33-7234-001	106	34-8605-001	73	35-2021-011	56	37-8400-001	93
31-6564-144	126	31-7400-014	160	33-7234-011	106	34-8702-001	73	35-2021-021	56	37-8407-001	93
31-6564-154	126	31-7600-001	90	33-7234-021	106	34-8706-001	73	35-2021-031	56	37-9207-001	79
31-6604-014	134	31-7600-701	91	33-7234-031	106	34-8806-001	73	36-1204-034	176	37-9207-011	81
31-6604-034	134	31-7704-014	142	33-7234-041	106	34-8940-001	62	36-1207-004	176	37-9220-001	81
31-6604-074	134	31-7704-034	142	33-7234-051	106	34-8940-011	62	36-3000-134	172	37-9220-011	81
31-6604-094	134	31-7704-054	142	33-7234-061	106	34-8940-021	62	36-3002-014	172	37-9230-001	79
31-6604-114	134	31-7704-094	142	33-7234-071	106	34-8940-031	62	36-3003-014	172	38-7200-001	77
31-6607-004	134	31-7704-124	142	33-7234-081	106	34-8940-041	62	36-3004-014	172	38-7207-001	77
31-6607-054	134	31-7707-034	142	33-7344-014	83	34-8940-051	62	36-3004-024	172	38-7600-001	90
31-6614-014	134	31-7707-104	142	33-7344-024	83	34-8941-001	62	36-3004-034	172	38-7600-701	91
31-6614-034	134	31-7707-114	142	33-7344-044	83	34-8941-011	62	36-3004-044	172	38-8000-031	97
31-6614-074	134	31-7707-214	142	33-8100-001	86	34-8941-021	62	36-3004-054	172	38-8000-051	97
31-6614-094	134	31-7764-014	142	33-8100-101	86	34-8941-031	62	36-3004-084	174	38-8000-061	97
31-6664-014	134	31-7764-214	142	33-8100-201	88	34-8941-041	62	36-3004-184	174	38-8007-131	97
31-6664-031	134	31-7764-234	142	33-8100-501	86	34-8941-051	62	36-3007-084	172	38-8007-141	97
31-6667-014	134	31-7804-014	142	33-8100-601	86	35-0201-001	69	36-3007-254	172	38-8007-151	97
31-6700-014	159	31-7804-054	142	33-8100-701	88	35-0201-011	69	36-3007-264	172	38-8107-061	93
31-6700-024	159	31-7804-094	142	33-8107-031	88	35-0201-021	69	36-3007-284	172	38-8200-001	194
31-6700-034	159	31-7804-124	142	33-8107-041	86	35-0201-031	69	36-3007-394	172	38-8204-011	189
31-6700-044	159	31-7804-144	142	33-8107-051	86	35-0201-041	69	36-3007-464	172	38-8207-001	194
31-6700-064	159	31-8524-004	122	33-8180-001	86	35-0202-001	69	36-3007-574	172	38-8207-011	194
31-6704-014	162	31-8524-014	122	33-8205-031	96	35-0202-011	69	36-3600-004	170	38-8220-001	190
31-6704-054	162	31-8524-024	122	33-8205-081	96	35-0202-021	69	36-3600-014	170	38-8220-011	189
31-6704-064	159	31-8524-044	122	33-8205-101	96	35-0202-031	69	36-3600-024	170	38-8220-021	189
31-6704-074	159	31-8900-024	180	33-8206-031	96	35-0202-041	69	36-3600-044	170	38-8221-001	192
31-6704-084	159	31-8900-044	180	33-8206-091	96	35-0203-001	67	36-3604-004	170	38-8221-101	192
31-6704-094	159	31-8907-004	180	33-8206-101	96	35-0203-011	67	36-3604-014	170	38-8226-001	189
31-6704-104	159	31-8907-014	180	33-8400-011	92	35-0203-021	67	36-3604-024	170	38-8226-101	189
31-6704-114	159	31-8910-014	180	33-8402-031	92	35-0203-031	67	36-3607-004	170	38-8226-111	189
31-6704-124	159	31-8910-024	180	33-8403-031	92	35-0203-041	67	36-3607-014	170	38-8227-001	192
31-6704-204	159	31-8920-001	81	33-8403-041	93	35-0203-051	67	36-3607-024	170	38-8227-021	189
31-6707-004	162	31-8927-001	81	33-8405-081	93	35-0203-061	67	36-3607-034	170	38-8227-101	192
31-6707-044	162	31-9000-054	180	33-8405-091	93	35-0203-071	67	36-3607-074	170	38-8407-001	93
31-6707-054	159	31-9007-014	180	33-8405-101	93	35-0203-081	67	36-3607-094	170	38-8524-001	185
31-6800-014	160	31-9207-001	79	33-8406-081	93	35-0203-091	67	36-3690-004	170	38-8524-011	184
31-6804-014	162	31-9207-011	79	33-8406-091	93	35-0203-101	67	36-3690-014	170	38-8524-031	186
31-6804-064	160	31-9207-021	79	33-8406-101	93	35-0203-111	67	36-3690-024	170	38-8524-041	186
31-6804-074	160	31-9207-031	79	33-8407-014	93	35-0203-121	67	36-3690-034	170	38-8524-051	185
31-6804-084	160	31-9207-041	81	33-8914-001	81	35-0203-131	67	36-3690-044	170	38-8524-061	184
31-6804-094	160	31-9207-051	81	33-8914-011	81	35-0203-141	67	36-3704-101	166	38-8524-071	185
31-6807-014	160	31-9207-061	79	33-9200-001	85	35-0204-001	68	36-3704-111	166	38-8524-081	185
31-6807-024	162	31-9207-071	79	33-9200-011	85	35-0204-011	68	36-3704-131	166	38-9000-001	200
31-6900-014	131	31-9207-081	79	33-9200-021	85	35-0204-021	68	36-3704-141	166	38-9007-011	200
31-6904-014	131	31-9220-001	81	33-9200-201	88	35-0204-031	68	36-3704-151	166	38-9010-001	200
31-6904-034	131	31-9220-011	81	33-9200-211	88	35-0204-041	68	36-3704-171	166	38-9100-001	200
31-6904-054	131	31-9221-001	81	33-9200-221	88	35-0204-051	68	36-3704-181	166	38-9100-081	200
31-6904-124	131	31-9221-011	81	33-9200-501	85	35-0204-061	68	36-3704-191	166	38-9107-011	200
31-6904-164	131	31-9230-001	79	33-9200-511	85	35-0204-071	68	36-3804-004	168	38-9207-001	79
31-6907-034	131	31-9231-001	79	33-9200-521	88	35-0204-081	68	36-3804-014	168	38-9207-011	81
31-6964-004	131	31-9231-201	79	33-9200-531	88	35-0204-091	68	36-3805-004	168	38-9207-021	79
31-7100-004	155	31-9231-211	79	33-9200-701	88	35-0204-101	68	36-3806-004	168	38-9220-001	81
31-7100-014	155	32-7000-701	92	33-9200-711	88	35-0204-111	68	36-3807-004	168	38-9220-011	81
31-7100-034	155	32-7200-001	77	33-9207-051	85	35-0204-121	68	36-3810-004	168	38-9230-001	79
31-7100-054	155	32-7207-001	77	33-9207-061	88	35-0204-131	68	36-3864-004	168	38-9231-001	79
31-7100-064	155	32-7344-014	83	33-9207-081	85	35-0204-141	68	36-3864-014	168	38-9237-001	79
31-7100-114	155	32-7344-024	83	33-9207-091	88	35-0301-001	58	36-3865-004	168	39-6400-011	198
31-7104-004	155	32-7600-001	90	33-9280-001	85	35-0301-011	58	36-3867-004	168	39-6400-031	198
31-7104-014	155	32-7600-701	91	34-3814-001	54	35-0301-021	58	36-3867-014	168	39-6400-041	198
31-7104-024	155	33-4114-001	100	34-3814-011	54	35-0301-041	58	36-3867-024	168	39-6407-001	198
31-7104-034	155	33-4124-071	100	34-3814-021	54	35-0302-001	58	37-7200-001	77	39-6407-011	198
31-7104-054	155	33-4124-241	102	34-5703-001	75	35-0302-011	58	37-7207-001	77	39-6800-011	196
31-7107-014	155	33-4124-251	102	34-5703-011	75	35-0302-021	58	37-7600-001	90	39-6801-001	196
31-7110-004	155	33-4124-261	102	34-5705-001	75	35-0302-041	58	37-7600-701	91	39-6807-001	196
31-7204-014	155	33-4124-271	102	34-5802-001	75	35-2020-001	56	37-8000-041	97	39-7000-001	93
31-7204-024	155	33-7200-001	77	34-5802-011	75	35-2020-011	56	37-8000-061	97	39-7007-001	93
31-7204-044	155	33-7200-011	77	34-5806-001	75	35-2020-021	56	37-8007-131	97	39-8404-001	206
31-7207-014	155	33-7207-041	77	34-8503-001	73	35-2020-031	56	37-8007-161	97	39-8409-001	206
31-7210-004	155	33-7207-051	77	34-8505-001	73	35-2021-001	56	37-8007-191	97	39-8700-011	207

## BESTELLNUMMERN / PART NUMBERS

ARTIKEL NR PART NO	SEITE PAGE	ARTIKEL NR PART NO	SEITE PAGE	ARTIKEL NR PART NO	SEITE PAGE
39-8704-001	207	68-5000-634	127	87-1284-004	220
39-8704-011	207	68-5000-634	173	87-1285-004	220
39-8707-001	207	68-5000-634	175	87-1286-004	223
39-8900-001	204	68-5018-004	143	87-1366-011	139
39-8900-051	204	68-5018-024	143	87-1368-011	139
39-8900-101	204	68-7502-361	220	87-3047-021	98
39-8900-151	204	68-7502-371	220	87-3048-021	98
39-8900-201	204	68-7503-004	220	87-3067-001	98
39-8900-251	204	68-7503-011	220	87-3068-001	98
39-8900-301	205	68-7503-021	220	87-3079-001	93
39-8900-351	205	68-7503-041	220	87-3080-001	93
39-8900-401	205	68-7503-174	220	87-3081-001	98
39-9093-004	229	69-0001-004	213	87-3082-001	98
53-1667-034	215	69-0002-004	213	97-1103-021	239
53-6768-004	214	69-0003-004	213	97-1104-021	239
58-1955-004	238	69-0078-014	228	97-1105-021	239
58-1957-004	238	69-0078-014	232	97-1106-021	239
58-3008-001	213	69-0236-004	188	97-1107-021	239
58-6024-014	215	69-0236-014	188	99-3010-224	230
58-6647-001	214	69-0236-024	188	99-3010-244	230
58-6649-004	214	69-0236-034	188	99-3010-284	230
65-1003-004	216	69-0236-044	188	99-3010-294	230
65-1003-014	216	69-0236-054	188		
65-1003-021	216	69-6268-004	229		
65-1005-004	216	75-0000-004	233		
65-1005-011	216	75-0001-004	229		
65-1005-024	216	75-0001-004	231		
65-1007-004	216	75-0001-004	232		
65-1007-014	216	75-0002-004	233		
65-1007-024	216	75-0100-004	233		
65-1499-004	225	75-0201-611	231		
65-1499-014	225	75-0204-111	231		
65-1512-004	228	75-0213-044	228		
65-6003-001	232	75-0300-101	33		
65-6003-011	232	75-0300-101	241		
65-6101-024	224	75-0309-001	21		
65-6499-004	223	75-0309-001	241		
65-6502-014	78	75-0310-001	241		
66-8892-004	222	75-0314-001	242		
66-8893-004	222	75-0324-001	242		
68-0002-334	228	75-0326-034	234		
68-0049-014	228	75-0328-001	234		
68-0049-014	232	75-0329-001	234		
68-0070-004	228	75-0331-001	234		
68-0076-004	228	75-0341-001	235		
68-0111-004	232	75-0360-004	234		
68-4800-004	221	76-5100-001	218		
68-4855-001	221	76-5100-041	218		
68-4888-004	221	76-5123-001	217		
68-4888-004	234	76-5123-111	217		
68-4980-034	224	76-5132-011	241		
68-4983-004	221	76-5158-001	228		
68-5000-014	132	76-5203-001	219		
68-5000-014	137	76-6425-101	231		
68-5000-014	143	76-6425-201	231		
68-5000-014	154	76-6430-001	217		
68-5000-034	132	76-6430-261	217		
68-5000-034	137	76-7001-001	213		
68-5000-034	143	76-7037-001	212		
68-5000-034	154	76-7069-001	212		
68-5000-574	127	76-7072-001	212		
68-5000-574	173	76-9023-001	238		
68-5000-574	175	76-9027-001	80		
68-5000-574	177	76-9027-001	82		
68-5000-604	127	76-9028-001	80		
68-5000-604	173	76-9028-001	82		
68-5000-604	175	76-9035-021	236		
68-5000-624	173	76-9035-031	236		
68-5000-624	175	78-7013-004	228		



























# PIKTOGRAMMÜBERSICHT / PICTOGRAM OVERVIEW

<b>PIKTOGRAMM ÜBERSICHT</b>			
	Verpackungseinheit		Seitenmarkierungslicht + Reflektor
	x Stück pro Karton		Begrenzungslicht hinten
	links		Begrenzungslicht vorne
	rechts		rot, weiß, orange
	Leuchtmittel		rot, weiß
	Volt		rot
	Umrissarm		weiß
	Glühbirne		Umrissleuchte
	LED		Rückstrahler rot
	Blinklicht		Rückstrahler gelb
	Blinklicht rechts		Rückstrahler weiß
	Blinklicht links		Arbeitsscheinwerfer
	dynamischer Blinker		Kennzeichenlicht
	dynamischer Blinker rechts		Rückfahralarm
	dynamischer Blinker links		männlich
	SMCG (Steuerung blinkender Seitenmarkierungsleuchten)		weiblich
	mit integriertem Blink-LCG		Flood
	mit integriertem LCG2		Spot
	Rücklicht		horizontal Anbau
	Bremslicht		vertikal Anbau
	Nebelschlusslicht		360° Anbau möglich
	Rückfahrlicht		... Lumen
	Dreieckrückstrahler		... Watt
	ohne Dreieckrückstrahler		ADR Zone 2
	Positionslicht		IP xx Schutzklasse
	Seitenmarkierungslicht		
	Reflektor (Seitenmarkierungslicht)		

<b>PICTOGRAM OVERVIEW</b>			
	Packaging unit		Sidemarket light + reflector
	x pieces per box		Rear position light
	Left		Front position light
	Right		red, white, amber
	Light source		red, white
	Volt		red
	End Outline marker		white
	Bulb		End outline marker
	LED		Reflector red
	Direction indicator		Reflector amber
	Direction indicator right		Reflector white
	Direction indicator left		Working lamp
	Progressive direction indicator		Number plate light
	Progressive direction indicator right		Reverse alarm
	Progressive direction indicator left		Male
	SMCG (Side Marker Control Gear)		Female
	With integrated direction indicator LCG		Flood
	With integrated LCG2		Spot
	Tail light		Horizontal mounting
	Stop light		Vertical mounting
	Fog light		360° mounting possible
	Reverse light		... Lumen
	Triangle reflector		... Watt
	Without triangle reflector		ADR Zone2
	Position light		IP xx Rating
	Sidemarket light		
	Reflector (Sidemarket light)		

## PIKTOGRAMMÜBERSICHT / PICTOGRAM OVERVIEW

 <b>LEGENDA</b>			
	Pezzi per confezione		Luce laterale + catadiottro
	Pezzi per scatola		Luce di posizione posteriore
	Sinistro		Luce di posizione anteriore
	Destro		Rosso, bianco, arancione
	Tipo di luce		Rosso, bianco
	Volt		Rosso
	Luce d'ingombro		Bianco
	Lampadina		Luce d'ingombro
	LED		Catadiottro rosso
	Freccia		Catadiottro arancione
	Freccia destra		Catadiottro bianco
	Freccia sinistra		Faro da lavoro
	Indicatore di direzione progressivo		Luce targa
	Freccia progressiva destra		Segnalatore acustico per retromarcia
	Freccia progressiva sinistra		Maschio
	Marcatori laterali di controllo		Femmina
	Con LCG per freccia		Flood
	Con LCG per tutte le funzioni		Spot
	Luce di posizione		Montaggio orizzontale
	Stop		Montaggio verticale
	Retronebbia		Montaggio a 360°
	Retromarcia		Lumen
	Catadiottro triangolare		Watt
	Senza catadiottro triangolare		ADR Zone 2
	Luce di posizione destra		IPXX
	Luce laterale		
	Catadiottro (Luce laterale)		

 <b>LÉGENDE DES PICTOGRAMMES</b>			
	Conditionnement		Feu latéral orange+catadioptré
	X pièces par carton		Feu de gabarit arrière
	Gauche		Feu de gabarit avant
	Droit		Rouge, blanc, orange
	Source lumineuse		Rouge, blanc
	Voltage		Rouge
	Feu sur antenne		Blanc
	Ampoule		Feu d'encombrement
	LED		Catadioptré rouge
	Clignotant		Catadioptré orange
	Clignotant droit		Catadioptré blanc
	Clignotant gauche		Phare de travail
	Indicateur de sens progressif		Eclaireur de plaque
	Clignotant à défilement droit		Alarme de recul
	Clignotant à défilement gauche		Mâle
	Équipement de contrôle des marqueurs latéraux		Femelle
	Avec LCG clignotant intégré		Large
	Avec LCG toutes fonctions intégré		Étroit
	Feu de position		Montage horizontal
	Feu de stop		Montage vertical
	Feu de brouillard		Montage à 360° possible
	Feu de recul		... Lumen
	Catadioptré triangulaire		... Watt
	Sans catadioptré triangulaire		ADR Zone 2
	Feu de gabarit		Classe IPxx
	Feu latéral orange		
	Catadioptré (Feu latéral orange)		

# PIKTOGRAMMÜBERSICHT / PICTOGRAM OVERVIEW

## DESCRIPCIÓN DE PICTOGRAMA

	Unidad de embalaje		Luz lateral + reflectante
	x piezas por caja		Gálibo trasero
	Izquierdo		Gálibo delantero
	derecho		rojo, blanco, ambar
	Tipo de luz		rojo, blanco
	Voltaje		rojo
	Cuerno final de línea		blanco
	Lámpara		Cuerno final de línea
<b>LED</b>	Led		Reflectante rojo
	Indicador de dirección		Reflectante ambar
	Indicador de dirección-derecho		Reflectante blanco
	Indicador de dirección izquierdo		Faro de trabajo
	Indicador de dirección progresiva		Luz de matrícula
	Indicador de dirección progresivo derecho		Retro-alarma
	Indicador de dirección progresivo izquierdo		Macho
	Equipo de control del marcador lateral		Hembra
	Con indicador de dirección integrado en LCG		Amplia
	Con LCG integrado (todas las funciones)		Larga
	Luz de gálibo		Montaje Horizontal
	Luz de Freno		Montaje Vertical
	Luz Antiniebla		Montaje 360°
	Luz Marcha atrás		Lumen
	Triángulo reflectante		Wattios
	Sin Triángulo reflectante		Zona 2 ADR
	Luz de posición		Tipo IPxx
	Luz lateral		
	Reflectante (Luz lateral)		

## LEGENDA

	Jednostka miary		Światło obrysowe boczne + odbłask
	x sztuk w kartonie		Światło pozycyjne tylne
	Lewa		Światło pozycyjne przednie
	Prawa		Czerwone, Białe, Pomarańczowe
	Źródło światła		Czerwone, Białe
	Napięcie		Czerwone
	Obrys gumowy narożny		Białe
	Żarówka		Obrys gumowy narożny
<b>LED</b>	LED		Odblask czerwony
	Kierunkowskaz		Odblask pomarańczowy
	Prawy kierunkowskaz		Odblask biały
	Lewy kierunkowskaz		Lampa robocza
	Progresywny wskaźnik kierunku		Oświetlenie tablicy rejestracyjnej
	Prawy kierunkowskaz progresywny		Dźwiękowy sygnalizator cofania
	Lewy kierunkowskaz progresywny		Męska
	Przekładnia kontrolująca markery boczne		Żeńska
	Ze zintegrowanym LCD dla kierunkowskazu		Światło rozproszone
	Ze zintegrowanym LCD dla wszystkich funkcji		Światło skupione
	Światło pozycyjne tylne		Montaż poziomy
	Stop		Montaż pionowy
	Światło przeciwmgłowe		Możliwość montażu 360°
	Wsteczny		Lumen
	Trójkąt z odbłaskiem		Watt
	Trójkąt bez odbłasku		Sterfa 2 ADR
	Światło pozycyjne		Klasa IPXX
	Światło obrysowe boczne		
	Odblask (Światło obrysowe boczne)		

## PIKTOGRAMMÜBERSICHT / PICTOGRAM OVERVIEW

PIKTOGRAM ÖZETİ	
	Paketleme Sayısı
	Her kutuda x adet
	Sol
	Sağ
	Lamba
	Voltaj
	Boynuz Lamba
	Ampul
	LED
	Sinyal Lamba
	Sinyal Lamba Sağ
	Sinyal Lamba Sol
	Aşamalı yön göstergesi
	Progresif Sinyal Lamba Sağ
	Progresif Sinyal Lamba Sol
	Yan İşaretleme Kontrol Dişlisi
	LCG'li sinyal lamba
	LCG'li (Bütün Fonksiyonlar)
	Park Lamba
	Fren Lamba
	Sis Lamba
	Geri Vites Lamba
	Üçgen Reflektör
	Üçgen Reflektörsüz
	Pozisyon Lamba
	Yan Park Lamba
	Reflektör (Yan Park Lamba)
	Yan Park Lamba+Reflektör
	Gabari Lamba - Kırmızı
	Pozisyon Lamba - Beyaz
	Kırmızı, Beyaz, Sarı
	Kırmızı, Beyaz
	Kırmızı
	Beyaz
	Boynuz Lamba
	Kırmızı Reflektör
	Sarı Reflektör
	Beyaz Reflektör
	Çalışma Lambası
	Plaka Lambası
	Geri Vites İkaz Sireni
	Erkek
	Dişi
	Geniş Açı
	Spot
	Yatay Montaj
	Dikey Montaj
	360° Uygulanabilir
	... Lumen
	... Watt
	ADR Zone 2
	IP Sınıfı

KUVIEN SELITYS	
	Pakkauskoko
	X per laatikko
	Vasen
	Oikea
	Valolähde
	Voltia
	Kumivarsivalo
	Polttimo
	LED
	Vilkku
	Vilkku oikea
	Vilkku vasen
	Progressiivinen suunta- vilkku
	Progressiivinen vilkku oikea
	Progressiivinen vilkku vasen
	Sivumerkinnän ohjau- s-laite
	LCG:llä vilkkua varten
	LCG:llä kaikkia toiminto- ja varten
	Parkkivalo
	Jarruvalo
	Sumuvalo
	Peruutusvalo
	Heijastinkolmio
	Ilman heijastavaa kol- miota
	Äärivalo
	Sivuäärivalo
	Heijastin (Sivuäärivalo)
	Sivuäärivalo + heijastin
	Takaäärivalo
	Etuäärivalo
	Punainen, valkoinen, keltainen
	Punainen, valkoinen
	Punainen
	Valkoinen
	Kumivarsivalo
	Heijastin punainen
	Heijastin keltainen
	Heijastin valkoinen
	Työvalo
	Rekisterikilven valo
	Peruutushälytін
	Uros
	Naaras
	Leveä valokuvio (flood)
	Kapea valokuvio (spot)
	Vaaka-asennus
	Pystyasennus
	360° asennus mahdol- linen
	... Lumenia
	... Wattia
	ADR Zone 2
	IP xx luokitus

# PIKTOGRAMMÜBERSICHT / PICTOGRAM OVERVIEW

ÖVERSIKT	
	Förpacknings-storlek
	x per kartong
	Vänster
	Höger
	Ljuskälla
	Volt
	Breddmarkering
	Glödlampa
	LED
	Blinkers
	Blinkers Höger
	Blinkers Vänster
	Indikator för progressiv riktning
	Progressiv blinkers höger
	Progressiv blinkers vänster
	Sidmarkörskontroll
	Med integrerad LCG för blinkers
	Med integrerad LCG för alla funktioner
	Parkeringsljus
	Bromsljus
	Dimljus
	Backljus
	Reflextriangel
	Utan reflextriangel
	Positionsljus
	Sidomarkeringsljus
	Reflex (Sidomarkeringsljus)
	Sidomarkering + reflex
	Bakre positionsljus
	Främre positionsljus
	Röd, vit, gul
	Röd, vit
	Röd
	Vit
	Breddmarkering
	Reflex röd
	Reflex gul
	Reflex vit
	Arbetsbelysning
	Nummerplåtsbelysning
	Backvarnare
	Hane
	Hona
	Bred ljusbild (flood)
	Smal ljusbild (spot)
	Horisontell montering
	Vertikal montering
	360° montering möjlig
	...Lumen
	...Watt
	ADR Zone 2
	IP xx Klass

PICTOGRAM OVERZICHT	
	Verpakkingseenheid
	x stuks per doos
	links
	rechts
	lichtbron
	volt
	Pendelarm
	bollamp
	LED
	Knipperlicht
	Knipperlicht rechts
	Knipperlicht links
	Progressieve richtingaanwijzer
	dynamisch knipperlicht rechts
	dynamisch knipperlicht links
	Zijmarkeringsbediening
	met geïntegreerde knipperlicht LCG
	met geïntegreerde LCG (alle functies)
	Achterlicht
	Remlicht
	Mistlicht
	Achteruitrijlicht
	Driehoek reflector
	zonder driehoek reflector
	Positielicht
	Zijmarkeringslicht
	Reflector (Zijmarkeringslicht)
	Zijmarkeringslicht + reflector
	Positielicht achter
	Positielicht voor
	rood, wit, oranje
	rood, wit
	rood
	wit
	markeringslicht
	Reflector rood
	Reflector geel
	Reflector wit
	Werklamp
	Kentekenlamp
	Achteruitrij alarm
	mannelijk
	vrouwelijk
	Flood
	Spot
	horizontale montage
	verticale montage
	360° montage mogelijk
	Lumen
	Watt
	ADR Zone 2
	IPxx Klasse





# THE ART OF LIGHTS

## Aspöck Systems GmbH

Enzing 4 | 4722 Peuerbach | AUSTRIA

Phone.: +43 72 76 / 26 70-0

Mail: office@aspoeck.com | aspoeck.com



# aspoeck.com

### GREAT BRITAIN, IRELAND

**Aspöck UK Ltd.**  
Unit 19, Stansted Distribution Centre  
Great Hallingbury  
Bishops Stortford, Herts  
GB-CM22 7DG  
Phone: +44 1279 655 220  
Fax: +44 1279 505 869  
Mail: sales@aspoeck.co.uk  
www.aspoeck.co.uk

### FRANCE, LUXEMBOURG ALGERIA, MOROCCO, TUNISIA

**Aspöck France S.A.S.**  
ZAC Bel Air  
260 Rue des Vergers  
F-69480 Pommiers  
Phone: +33 437 5508 65  
Fax: +33 437 5508 97  
Mail: office@aspoeck.fr

### SPAIN, PORTUGAL

**Aspöck Iberica**  
Via Sergia, 32 Nave N° 2  
Poligono Industrial  
"Les Hortes del Cami Real"  
E-08302 Mataro (Barcelona)  
Phone: +34 937 598 039  
Fax: +34 937 501 033  
Mail: aspock@aspock.com  
www.aspock.com

### SWEDEN, FINLAND, NORWAY, DEN- MARK, ESTONIA

**Aspöck Norden AB**  
Honungsgatan 4  
SE-432 48 Varberg  
Phone: +46 340 483 870  
Fax: +46 340 483 879  
Mail: info@aspoeck-norden.se

### ITALY

**PAGG Aspöck srl**  
Via Legnano, 8  
I-20835 Muggiò (MB)  
Phone: +39 039 278 5255  
Fax: +39 039 278 9582  
Mail: info@aspoeck.it

### BRAZIL

**Aspöck do Brasil Ltda.**  
Estrada RS 122 km 88,5 S/N  
Bairro São Gotardo  
Flores da Cunha-RS  
CEP 95270-000  
Phone: +55 54 3039-5400  
Mail: contato@aspock.com.br

### POLAND, LITHUANIA, LATVIA, UKRAINE

**Aspöck Systems Polska Sp.z.o.o.**  
ul. Byczyńska 10  
46-320 Praszka  
Phone: +48 34 3430 600  
Fax: +48 34 3430 609  
Mail: office.poland@aspoeck.com

### TURKIYE, MIDDLE EAST

**Aspöck Aydınlatma Sistemleri Tic. Ltd.**  
Feneryolu Mah. Yıldırım Sok.  
No 20/B PK: 34724  
Kadıköy / İstanbul  
Türkei  
Phone: +90 (0) 216 5105400-3 lines

### GERMANY

**Suer GmbH & Co KG**  
Handelsstraße 5  
D-42929 Wermelskirchen  
Phone: +49 2196 946 0  
Fax: +49 2196 946 100  
Mail: info@suer.de

### GERMANY

**Hofmeister & Meincke**  
Carsten-Dressler-Straße 6  
D-28279 Bremen  
Phone: +49 421 8405 296  
Fax: +49 421 8405 201  
Mail: bremen@hofmei.de

### AUSTRIA, HUNGARY, CROATIA, CZECH REPUBLIC

**Ing. A. F. Baeder Ges.m.b.H.**  
Kolpingstraße 13  
A-1230 Wien  
Phone: +43 1 865 16 40  
Fax: +43 1 869 22 12  
Mail: sales@baeder-automotive.com

### AUSTRIA (12V ONLY)

**Knott Handelsges.m.b.H.**  
Rennweg 79-81  
A-1030 Wien  
Phone: +43 1 714 22 22  
Fax: +43 1 714 22 33  
Mail: info@knott.at

### SWITZERLAND

**AGL AG für Lastwagenzubehöre**  
Müslistrasse 43  
CH-8957 Spreitenbach  
Phone: +41 41 348 04 80  
Fax: +41 41 340 31 79  
Mail: info@agl.ch

### NETHERLANDS, BELGIUM

**Frits Dijk International**  
Collse Heide 64  
NL-5674 VN Nuenen  
Phone: +31 40 2831815  
Fax: +31 40 2838717  
Mail: info@fritsdijk.nl

### SERBIA, ROMANIA, BULGARIA, SLOVAKIA

**Ing. A. F. Baeder Ges.m.b.H.**  
Kolpingstraße 13  
A-1230 Wien  
Phone: +43 1 865 16 40  
Fax: +43 1 869 22 12  
Mail: sales@baeder-automotive.com

### MONTENEGRO, SLOVENIA, BOSNIA AND HERZEGOVINA

**Ing. A. F. Baeder Ges.m.b.H.**  
Kolpingstraße 13  
A-1230 Wien  
Phone: +43 1 865 16 40  
Fax: +43 1 869 22 12  
Mail: sales@baeder-automotive.com

### ISRAEL

**M.N. Systems**  
Pier St., Industrial Park Emek 10  
Hefer, IL-3877701  
P.O.B 12186  
Phone: +97 24 6220 111  
Fax: +97 24 6220 808  
Mail: info@mnsys.co.il

### EAST ASIA

**JM Company**  
312-15, Jaedurumi-gil  
Paju-si, Gyeonggi-do  
10863, S. Korea  
Phone: +82 31 944 7670  
Fax: +82 31 947 7671

### RUSSIA, KYRGYZSTAN, MONGOLIA, BELARUS, KAZAKHSTAN

**STAT Ltd**  
125464, Moscow region,  
Volokolamskoe Highway  
House 142  
Pom. I, Room 35, Office 535  
Phone: +7 (495) 739-03-47  
Mail: info@stat-parts.ru  
www.stat-parts.ru

### SOUTH AFRICA, BOTSWANA, LESOTHO, NAMIBIA, ZIMBABWE, SWAZILAND

**Trail-Link South Africa**  
699 Seccull Avenue  
0084 Mayville, Pretoria  
P.O.B. 880  
Phone: +27 12 335 7402  
Mail: sales@trail-link.co.za

### USA

**Aspöck UK Ltd.**  
Unit 19, Stansted Distribution Centre  
Great Hallingbury  
Bishops Stortford, Herts  
CM22 7DG  
Phone: +44 1279 655 220  
Mail: sales@aspoeck.co.uk