

Pilotos Traseros LED
Pilotos Traseros
Pilotos Traseros para Remolque
Kits de Iluminación

LED Rear Combination Lamps
Rear Combination Lamps
Rear Combination Lamps Trailers
Lighting Kits

1.0 - 1.51.17
1.52 - 1.85
1.86 - 1.119
1.120 - 1.122

01



Piloto trasero LED

LED Rear Combination Lamp

Tipo: PRO-CAN XL 3F IP67

Función: Luz posición LED - Luz freno LED - Intermitente
Secuencial LED -
Fijación Horizontal

Function: LED Tail Lamp - LED Stop Lamp - LED Dir. Indicator
Sequential Lamp
Fixation horizontal

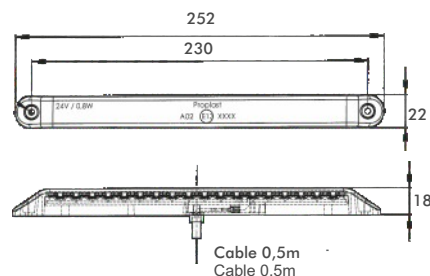

Referencia: Reference-No.	Ud. QTY	Izq. left	Dch. right	Luz Matrícula Numberplate- lamp	Descripción - Referencia O.E. Specification - O.E.-No.	Conector - Accesorios - Recambios Connector - Accessories - Spare Parts
P40.026.672 24V	1	■	■		Versión con cable 0,5m. 24V - 2,2W version cable 0,5m, 24V - 2,2W	 Intermitente Secuencial
P40.026.852 12V	1	■	■		Versión con cable 0,5m. 12V - 2,2W version cable 0,5m, 12V - 2,2W	 Intermitente Secuencial
P40.026.652 24V	1	■	■		Versión con cable 0,5m. 24V - 2,2W Tulipa transparente version cable 0,5m, 24V - 2,2W clear housing	 Intermitente Secuencial
P40.026.752 12V	1	■	■		Versión con cable 0,5m. 12V - 2,2W Tulipa transparente version cable 0,5m, 12V - 2,2W clear housing	 Intermitente Secuencial
P50.140.012 12V	1	■	■		Controlador LED, intermitente - posición- freno - antiniebla- marcha atrás, 2pilotos	+ info. página 9.0.0 PRO-LCG see page 9.0.0
P50.140.024 24V	1				LED Control Gear monitors the direction indicator lamp and is checking the stop-tail-fog- reversing lamp	
P50.141.012 12V	1	■	■		Controlador LED especial Intermitente	+ info. página 9.0.0 PRO-CONTROL see page 9.0.0
P50.141.024 24V	1	■	■		LED Control Gear Direction Indicator function	
P50.139.012 12V	1	■	■		Controlador LED funciones 21W	+ info. página 9.3.0 PRO-LOAD see page 9.3.0
P50.139.024 24V	1	■	■		LED Control Gear monitors the 21W functions	

Piloto trasero LED

LED Rear Combination Lamp

TIPO: PRO-TRUCK 24V IP67

Función: 2 x Luz posición LED - Luz de freno LED -
Luz intermitente secuencial LED - Luz marcha atrás LED
Luz antiniebla LED - Reflectante
Módulos LED + Reflectante reemplazables

Function: 2x LED Tail Lamp - LED Stop Lamp -
sequential LED Dir. Indicator Lamp - LED Reversing

Lamp -
LED Fog Lamp - Reflex Reflector

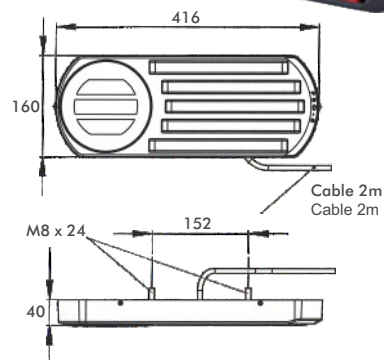

Característica: Función Intermitente secuencial.
Feature: sequential Direction Indicator Function

Referencia: Reference-No.	Ud. QTY	Izq. left	Dch. right	Luz Matrícula Numberplate- lamp	Descripción - Referencia O.E. Specification - O.E.-No.	Conector - Accesorios - Recambios Connector - Accessories - Spare Parts
P40.285.011	1	■			Versión con 2m de cable version with cable 2,0m	
P40.285.012	1		■		Versión con 2m de cable version with cable 2,0m	
P50.140.024 24V	1	■	■		Controlador LED, intermitente - posición- freno - antiniebla- marcha atrás, 2pilotos LED Control Gear monitors the direction indicator lamp and is checking the stop-tail-fog- reversing lamp	+ info página 9.0.0 PRO-LCG see page 9.0.0
P40.026.032 24V	1	■	■		Módulo LED Posición-Freno LED Unit Stop-Tail Lamp	PRO-CAN XL
P40.026.051 24V	1	■	■		Módulo LED Intermitente secuencial LED Unit sequential Dir. Indicator Lamp	PRO-CAN XL
P40.026.002 24V	1	■	■		Módulo LED Posición LED Unit Tail Lamp	PRO-CAN XL
P40.026.503 24V	1	■	■		Módulo LED Marcha atrás LED Unit Reversing Lamp	PRO-CAN XL
P40.026.022 24V	1	■	■		Módulo LED Antiniebla LED Unit Fog Lamp	PRO-CAN XL
P20.105.504	1	■	■		Reflectante de vidrio óptico brillante transparente Reflex Reflector in brilliant clear glass optic	PRO-T-REFLEX
P40.280.112	1	■	■		Cubierta para base piloto color antracita Cover for housing in anthracite	

NEW



PROPLAST
FAHRZEUGBELEUCHTUNG
www.aspoock.com
Catálogo 2022/2023

Piloto trasero LED

LED Rear Combination Lamp

Tipo: PRO-ROD 12/24V IP6K9K

Función: Luz de posición LED - Luz de freno LED - intermitente secuencial LED

Function: LED Tail Lamp - LED Stop Lamp - sequential LED Dir. Indicator Lamp

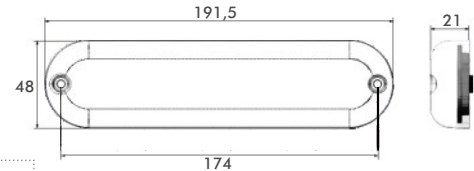

Característica: Intermitente secuencial
Feature: sequential Direction Indicator Function

Referencia: Reference-No.	Ud. QTY	Izq. left	Dch. right	Luz Matrícula Numberplate- lamp	Descripción - Referencia O.E. Specification - O.E.-No.	Conector - Accesorios - Recambios Connector - Accessories - Spare Parts
P40.244.001	1	■	■		Luz de posición LED Guía de led Cable 0,5m LED Tail Lamp in Light guide technology version cable 0,5m	
P40.244.501	1	■	■		Luz de posición LED Guía de led Cable 5m LED Tail Lamp in Light guide technology version cable 5,0m	
P50.140.012 12V	1	■	■		Centralita de control LED, intermitente - posición- freno - antiniebla- marcha atrás, 2 pilotos LED Control Gear monitors the direction indicator lamp and is checking the stop-tail-fog- reversing lamp	+ info. página 9.0.0 PRO-LCG
P50.140.024 24V	1					see page 9.1
P50.141.012 12V	1				Controlador LED especial Intermitente	+ info. página 9.0.0 PRO-CONTROL
P50.141.024 24V	1	■	■			
P50.141.500 12/24V	1				LED Control Gear Direction Indicator function	see page 9.9
P50.139.012 12V	1	■	■		Controlador LED especial funciones 21W	+ info. página 9.0.0 PRO-LOAD
P50.139.024 24V	1				LED Control Gear monitors the 21W functions	see page 9.10
P50.125.524 24V	1	■	■		Controlador LED especial luz posición LED Control Gear Tail Light function	+ info. página 9.10.0 see page 9.10

Piloto trasero LED

LED Rear Combination Lamp

Tipo: ECOLED II 12/24V IP6K9K





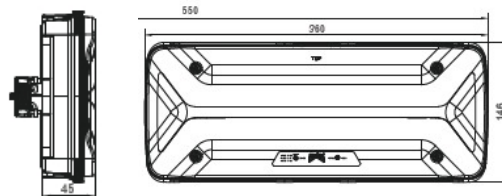

Función: Posición LED - Freno LED - Intermitente secuencial LED
 - Marcha atrás LED - Antiniebla LED - Opcional Gálilbo
 LED -Luz - Reflectante -

Function: LED Tail Lamp - LED Stop Lamp - Secuencial LED Dir.
 Indicator Lamp - LED Reversing Lamp - LED Fog Lamp -
 optional LED End Outline Marker Lamp - Reflex

Reflector



Referencia: Reference-No.	Ud. QTY	Izq. left	Dch. right	Luz Matrícula Numberplate- lamp	Descripción - Referencia O.E. Specification - O.E.-No.	Conector - Accesorios - Recambios Connector - Accessories - Spare Parts
A25-4121-061	1	■			Conector 7p AMP	
A25-4120-061	1		■		Conector 7p AMP	
A25-4126-061	1	■	■		Conector 7p AMP	 
A18-8536-011	1	■	■		Tulipa Lens	
P50.071.100	1	■	■		Kit Conector AMP Repairkit	

NEW



PROPLAST
FAHRZEUGBELEUCHTUNG
www.aspock.com
Catálogo 2022/2023

Piloto trasero LED

LED Rear Combination Lamp

Tipo: PRO-CARGO II "Truck" 12/24V

Función: Posición LED - Freno LED -
Intermitente secuencial LED -
Marcha atrás LED - Antiniebla LED -
Reflectante

Function: LED Tail Lamp - LED Stop Lamp -
sequential LED Dir. Indicator Lamp -
LED Reversing Lamp - LED Fog Lamp -
Reflex Reflector

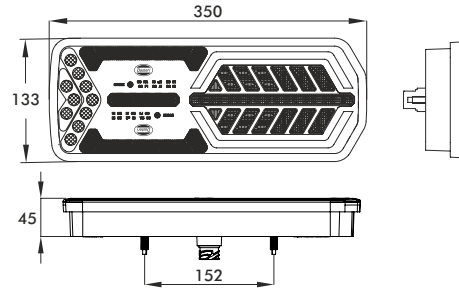

Referencia: Reference-No.	Ud. QTY	Izq. left	Dch. right	Luz Matrícula Numberplate- lamp	Descripción - Referencia O.E. Specification - O.E.-No.	Conector - Accesorios - Recambios Connector - Accessories - Spare Parts
P40.707.011	1	■			<p>Luz de posición Guía de LED Carcasa: ABS+PC Tulipa: PMMA+PC Conexión: Cable 2,0m Voltaje: 12/24 Volt Protección: IP6K9K Homolog.: ECE geprüft EMV geprüft</p> <p>Intermitente: 12V-3,5W / 24V-3,5W Posición: 12V-3,2W / 24V-3,2W Freno: 12V-2,0W / 24V-2,0W Antiniebla: 12V-4,0W / 24V-4,0W M. Atrás: 12V-2,5W / 24V-2,5W</p>	
P40.707.012	1		■		<p>LED Tail Lamp in Light guide technology Housing: ABS+PC Lens: PMMA+PC Cable: 2,0m open end Voltage: 12/24 Volt Protection: IP6K9K Homologation: ECE approved EMC approved</p> <p>Dir. Indicator: 12V-3,5W / 24V-3,5W Tail: 12V-3,2W / 24V-3,2W Stop: 12V-2,0W / 24V-2,0W Fog: 12V-4,0W / 24V-4,0W Reverse: 12V-2,5W / 24V-2,5W</p>	
P40.707.211	1	■			<p>Luz de posición Guía de LED Carcasa: ABS+PC Tulipa: PMMA+PC Conexión: Conector 7p AMP Voltaje: 12/24 Volt Protección: IP6K9K Homolog.: ECE geprüft EMV geprüft</p> <p>Intermitente: 12V-3,5W / 24V-3,5W Posición: 12V-3,2W / 24V-3,2W Freno: 12V-2,0W / 24V-2,0W Antiniebla: 12V-4,0W / 24V-4,0W M. Atrás: 12V-2,5W / 24V-2,5W</p>	
P40.707.212	1		■		<p>LED Tail Lamp in Light guide technology Housing: ABS+PC Lens: PMMA+PC Cable: 7-pin AMP connector Voltage: 12/24 Volt Protection: IP6K9K Homologation: ECE approved EMC approved</p> <p>Dir. Indicator: 12V-3,5W / 24V-3,5W Tail: 12V-3,2W / 24V-3,2W Stop: 12V-2,0W / 24V-2,0W Fog: 12V-4,0W / 24V-4,0W Reverse: 12V-2,5W / 24V-2,5W</p>	

NEW

Piloto trasero LED

LED Rear Combination Lamp

TIPO: PRO-TWIN-CAN 12/ 24V

Función: Posición LED - Freno LED - Intermitente LED

Unidad de Control Intermitente acorde ISO 13207-1

Function: LED Tail Lamp - LED Stop Lamp - LED Dir. Indicator Lamp

flasher control unit according to ISO 13207-1

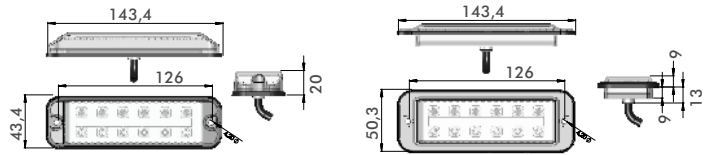
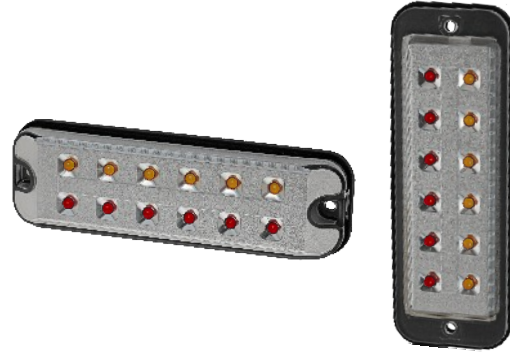

Referencia: Reference-No.	Ud. QTY	Izq. left	Dch. right	Luz Matrícula Numberplate- lamp	Descripción - Referencia O.E. Specification - O.E.-No.	Conector - Accesorios - Recambios Connector - Accessories - Spare Parts
P40.073.012 Superficie Pendant 	1	■	■		<p>Unidad de control Intermitente acorde ISO 13207-1 Diseño único y compacto Carcasa metalizada Tulipa: PMMA Conexión: 0,5m puntas abiertas Voltaje: 12/24 Volt Protección: IP6K9K Montaje: horizontal / vertical Homolog.: ECE ADR EMV Intermitente: 12V-1,0W / 24V-2,0W Posición: 12V-0,3W / 24V-0,6W Frenos: 12V-2,0W / 24V-4,0W</p>	
P40.073.712 Empotrable Recessed 	1	■	■		<p>Flasher control unit according to ISO 13207-1 unique compact design metalized cover Lens: PMMA Cable: 0,5m open end Voltage: 12/24 Volt Protection: IP6K9K Fixation: horizontal / vertical Homologation: ECE approved ADR approved EMC approved Dir. Indicator: 12V-1,0W / 24V-2,0W Tail: 12V-0,3W / 24V-0,6W Stop: 12V-2,0W / 24V-4,0W</p>	

**PROPLAST**

FAHRZEUGBELEUCHTUNG

www.aspock.com

Catálogo 2022/2023

Piloto trasero LED

LED Rear Combination Lamp

Tipo: PRO-TWIN-CAN ECO 12/24V

Funktion: Posición LED - Freno LED - Intermitente LED



Function: LED Tail Lamp - LED Stop Lamp - LED Dir. Indicator Lamp

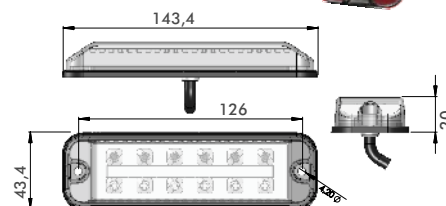

Referencia: Reference-No.	Ud. QTY	Izq. left	Dch. right	Luz Matrícula Numberplate- lamp	Descripción - Referencia O.E. Specification - O.E.-No.	Conector - Accesorios - Recambios Connector - Accessories - Spare Parts
P40.073.001 Superficie Pendant	1	■	■		<p>Diseño único y compacto Color rojo Tulipa: PMMA Conexión: 0,5m puntas abiertas Voltaje: 12/24 Volt Protección: IP6K9K Montaje: horizontal / vertical Homolog.: ECE ADR EMV</p> <p>Intermitente: 12V-1,0W / 24V-2,0W Posición: 12V-0,3W / 24V-0,6W Frenos: 12V-2,0W / 24V-4,0W</p> <p>Unique compact design red cover</p>	
					<p>Lens: PMMA Cable: 0,5m open end Voltage: 12/24 Volt Protection: IP6K9K Fixation: horizontal / vertical Homologation: ECE approved ADR approved EMC approved</p> <p>Dir. Indicator: 12V-1,0W / 24V-2,0W Tail: 12V-0,3W / 24V-0,6W Stop: 12V-2,0W / 24V-4,0W</p>	

NEW

ASPÖCK
IBERICA

PROPLAST
FAHRZEUGBELEUCHTUNG
www.aspock.com
Catálogo 2022/2023

Página 1.3.3

Piloto trasero LED

LED Rear Combination Lamp

Tipo: PRO-RAIL 5F 12V

Función: Posición LED - Freno LED - Intermitente LED -
Marcha atrás LED - Antiniebla LED -
Luz de matrícula LED - Reflectante
12V Unidad Control Intermitente
Montaje horizontal o vertical

Function: LED Tail Lamp - LED Stop Lamp - LED Dir. Indicator Lamp -
LED Reversing Lamp - LED Fog Lamp -
LED Numberplate Lamp - Reflex Reflector
12V Flasher control unit - Fixation horizontal or vertical

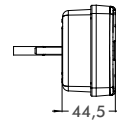
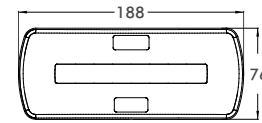
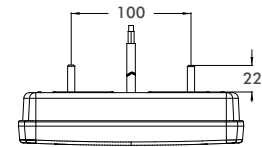

Referencia: Reference-No.	Ud. QTY	Izq. left	Dch. right	Luz Matrícula Numberplate- lamp	Descripción - Referencia O.E. Specification - O.E.-No.	Conector - Accesorios - Recambios Connector - Accessories - Spare Parts
P40.260.012 12V 	1	■	■		Luz de posición Guía de LED 12V Unidad control Intermitente Carcasa: ABS+PC Tulipa: PMMA Conexión: 2,0m puntas abiertas Voltaje: 12 Volt Protección: IP6K9K Montaje: horizontal / vertical Homolog.: ECE EMV Intermitente: 12V-2,2W Posición: 12V-1,8W Freno: 12V-1,5W Antiniebla: 12V-2,2W Marcha atrás: 12V-4,0W	
P40.260.013 12V 	1	■		■ Inferior/ below	LED Tail Lamp in Light guide technology 12V flasher control unit Housing: ABS+PC Lens: PMMA Cable: 2,0m open end Voltage: 12 Volt Protection: IP6K9K Fixation: horizontal / vertical Homologation: ECE approved EMC approved	
P40.260.014 Versión UK 12V 	1		■	■ inferior/ below	Dir. Indicator: 12V-2,2W Tail: 12V-1,8W Stop: 12V-1,5W Fog: 12V-2,2W Reverse: 12V-4,0W	
P40.260.015 12V 	1	■	■	■ lateral/ lateral		

NEW

ASPÖCK
IBERICA

PROPLAST

FAHRZEUGBELEUCHTUNG

www.aspock.com

Catálogo 2022/2023

Piloto trasero LED





LED Rear Combination Lamp

Tipo: PRO-RAIL 5F 12/24V

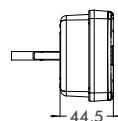
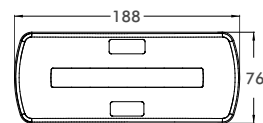
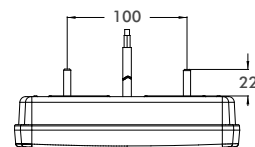
Función: Posición LED - Freno LED - Intermitente LED -
Marcha atrás LED - Antiniebla LED -
Luz de matrícula LED - Reflectante
Montaje horizontal o vertical

Function: LED Tail Lamp - LED Stop Lamp - LED Dir. Indicator Lamp -
LED Reversing Lamp - LED Fog Lamp -
LED Numberplate Lamp - Reflex Reflector
Fixation horizontal or vertical



Referencia: Reference-No.	Ud. QTY	Izq. left	Dch. right	Luz Matrícula Numberplate- lamp	Descripción - Referencia O.E. Specification - O.E.-No.	Conector - Accesorios - Recambios Connector - Accessories - Spare Parts
P40.260.001 12/24V	1	■	■		Luz de posición Guía de LED Carcasa: ABS+PC Tulipa: PMMA Conexión: 2,0m puntas abiertas Voltaje: 12/24 Volt Protección: IP6K9K Montaje: horizontal / vertical Homolog.: ECE EMV Intermitente: 12V-2,2W / 24V-2,2W Posición: 12V-1,8W / 24V-1,8W Freno: 12V-1,5W / 24V-1,5W Antiniebla: 12V-2,2W / 24V-2,2W Marcha atrás: 12V-4,0W / 24V-4,0W	 
P40.260.003 12/24V	1	■		■ Inferior/ below	LED Tail Lamp in Light guide technology Housing: ABS+PC Lens: PMMA Cable: 2,0m open end Voltage: 12/24 Volt Protection: IP6K9K Fixation: horizontal / vertical Homologation: ECE approved EMC approved	 
P40.260.004 Versión UK 12/24V	1		■	■ inferior/ below	Dir. Indicator: 12V-2,2W / 24V-2,2W Tail: 12V-1,8W / 24V-1,8W Stop: 12V-1,5W / 24V-1,5W Fog: 12V-2,2W / 24V-2,2W Reverse: 12V-4,0W / 24V-4,0W	Luz de Matrícula inferior Numberplate Lamp below
P40.260.005 12/24V	1	■	■	■ lateral/ lateral		 Luz de Matrícula lateral Numberplate Lamp lateral

NEW

ASPÖCK
IBERICA

PROPLAST
FAHRZEUGBELEUCHTUNG
www.aspock.com
Catálogo 2022/2023

Página 1.3.5

Piloto trasero LED

LED Rear Combination Lamp

Tipo: MAN

Función: Posición LED - Freno LED - Intermitente LED -
Marcha atrás LED - Antiniebla LED -
Luz de matrícula LED - Reflectante
Unidad Control Intermitente

Function: LED Tail Lamp - LED Stop Lamp - LED Dir. Indicator Lamp -
LED Reversing Lamp - LED Fog Lamp -
LED Numberplate Lamp - Reflex Reflector

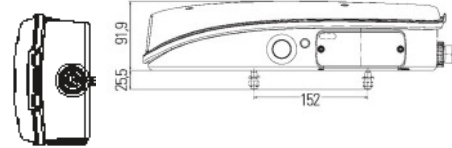
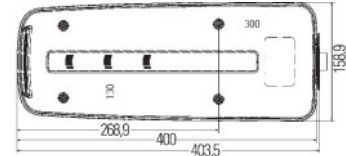

Referencia: Reference-No.	Ud. QTY	Izq. left	Dch. right	Luz Matrícula Numberplate- lamp	Descripción - Referencia O.E. Specification - O.E.-No.	Conector - Accesorios - Recambios Connector - Accessories - Spare Parts
P50.200.053 24V 	1	■		■ Inferior/ below	<p>Carcasa: ABS+PC Tulipa: PMMA Conexión: Conector AMP 7p Voltaje: 24 Volt Protección: IP5K4K, X9K Montaje: horizontal / vertical Homolog.: ECE EMV</p> <p>Intermitente: 24V-4,2W Posición: 24V-2,8W Freno: 24V-2,2W Antiniebla: 24V-2,5W Marcha atrás: 24V-4,7W Luz Matrícula: 24V-1,7W</p>	
P50.200.052 24V 	1		■		<p>Housing: ABS+PC Lens: PMMA Cable: AMP 7p. Connector Voltage: 24 Volt Protection: IP5K4K, X9K Fixation: horizontal Homologation: ECE approved EMC approved</p> <p>Dir. Indicator: 24V-4,2W Tail: 24V-2,8W Stop: 24V-2,2W Fog: 24V-2,5W Reverse: 24V-4,7W Number Plate 24V-1.7W</p>	Derecho con Avisador Acústico
P50.200.252 Tulipa	1	■	■		Tulipa Lens	
P50.071.100	1	■	■		Kit Bayoneta AMP Repairkit	

NEW



Piloto trasero LED

LED Rear Combination Lamp

Tipo: DAF

Función: Posición LED - Freno LED - Intermitente LED -
Marcha atrás LED - Antiniebla LED -
Luz de matrícula LED - Reflectante
Unidad Control Intermitente

Function: LED Tail Lamp - LED Stop Lamp - LED Dir. Indicator Lamp -
LED Reversing Lamp - LED Fog Lamp -
LED Numberplate Lamp - Reflex Reflector

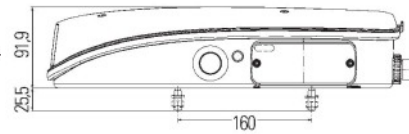
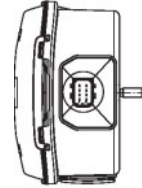
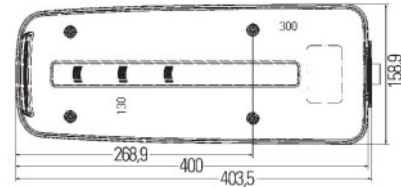

Referencia: Reference-No.	Ud. QTY	Izq. left	Dch. right	Luz Matrícula Numberplate- lamp	Descripción - Referencia O.E. Specification - O.E.-No.	Conector - Accesorios - Recambios Connector - Accessories - Spare Parts
P50.200.055 24V 	1	■		■ Inferior/ below	<p>Carcasa: ABS+PC Tulipa: PMMA Conexión: Conector HCSCS 8p. Voltaje: 24 Volt Protección: IP5K4K, X9K Montaje: horizontal / vertical Homolog.: ECE EMV</p> <p>Intermitente: 24V-4,2W Posición: 24V-2,8W Freno: 24V-2,2W Antiniebla: 24V-2,5W Marcha atrás: 24V-4,7W Luz Matrícula: 24V-1,7W</p>	
P50.200.054 24V 	1		■		<p>Housing: ABS+PC Lens: PMMA Cable: HCSCS 8p. Connector Voltage: 24 Volt Protection: IP5K4K, X9K Fixation: horizontal Homologation: ECE approved EMC approved</p> <p>Dir. Indicator: 24V-4,2W Tail: 24V-2,8W Stop: 24V-2,2W Fog: 24V-2,5W Reverse: 24V-4,7W Number Plate 24V-1.7W</p>	Derecho con Avisador Acústico
P50.200.352 Tulipa	1	■	■		<p>Tulipa Lens</p>	

Piloto trasero LED

LED Rear Combination Lamp

Tipo: VOLVO LC10 24V

Función: Posición LED - Freno LED - Intermitente LED -
Marcha atrás LED - Antiniebla LED - Gálbo LED - Luz
Matrícula LED - Reflectante - Opcional Retro-alarma

Function: LED Tail Lamp - LED Stop Lamp - LED Dir. Indicator
Lamp - LED Reversing Lamp - LED Fog Lamp -
LED End Outline Marker Lamp - LED Numberplate Lamp

- Reflex Reflector - Opt. Back Alarm System

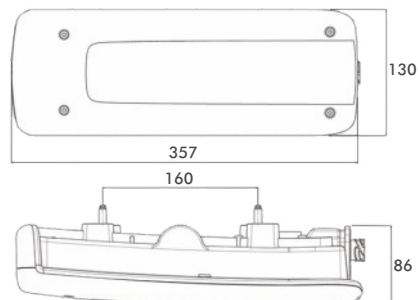

Referencia: Reference-No.	Ud. QTY	Izq. left	Dch. right	Luz Matrícula Numberplate- lamp	Descripción - Referencia O.E. Specification - O.E.-No.	Conector - Accesorios - Recambios Connector - Accessories - Spare Parts
P40.299.211	1	■			VOLVO 21735301	
P40.299.212	1		■		VOLVO 21735299	
P40.299.213	1	■		■	VOLVO 82483074	
P40.299.215	1		■		VOLVO 82483073 Retro-alarma Integrada Back Alarm System	
P40.299.112	1	■	■		VOLVO 84122332 Tulipa Lens	
P50.071.100	1	■	■		Kit Conector AMP Repairkit	
P50.120.000	2	■	■		Kit conector AMP con 4m. de cable Cablekit with AMP connector, 4m	

Piloto trasero LED

LED Rear Combination Lamp





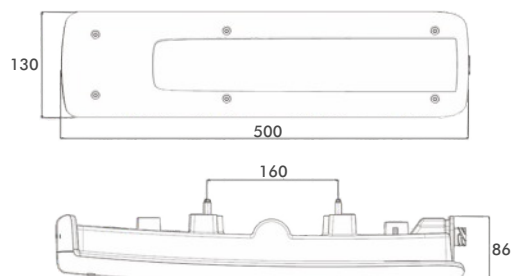

Tipo: LC9 VOLVO 24V

Función: Posición LED - Freno LED - Intermitente LED -
 Marcha atrás LED - Antiniebla LED - Gálbo LED - Luz
 Matrícula LED - Reflectante - Opcional Retro-alarma

Function: LED Tail Lamp - LED Stop Lamp - LED Dir. Indicator
 Lamp - LED Reversing Lamp - LED Fog Lamp -
 LED End Outline Marker Lamp - LED Numberplate Lamp

- Reflex Reflector - Opt. Back Alarm System



Referencia: Reference-No.	Ud. QTY	Izq. left	Dch. right	Luz Matrícula Numberplate- lamp	Descripción - Referencia O.E. Specification - O.E.-No.	Conector - Accesorios - Recambios Connector - Accessories - Spare Parts
P40.298.212	1		■		VOLVO 82849923	
P40.298.213	1	■		■	VOLVO 82849894	
P40.298.215	1		■		VOLVO 82849925 Retro-Alarma Integrada Back Alarm System	
P40.298.112	1	■	■		VOLVO 82849905 Tulipa Lens	
P50.071.100	1	■	■		Kit Conector AMP Repairkit	
P50.120.000	2	■	■		Kit conector AMP con 4m. de cable Cablekit with AMP connector, 4m	

Piloto trasero LED

LED Rear Combination Lamp

Tipo: SCANIA 24V

Función: Posición LED - Freno LED - Intermitente LED -
 Marcha atrás LED - Antiniebla LED - Gálbo LED - Luz
 Matrícula LED - Reflectante - Opcional Retro-alarma

Function: LED Tail Lamp - LED Stop Lamp - LED Dir. Indicator
 Lamp - LED Reversing Lamp - LED Fog Lamp -
 LED End Outline Marker Lamp - LED Numberplate Lamp

- Reflex Reflector - Opt. Back Alarm System



Referencia: Reference-No.	Ud. QTY	Izq. left	Dch. right	Luz Matrícula Numberplate- lamp	Descripción - Referencia O.E. Specification - O.E.-No.	Conector - Accesorios - Recambios Connector - Accessories - Spare Parts
P50.200.047	1	■		■	SCANIA 2241860	
P50.200.048	1		■		SCANIA 2241859 Retro-Alarma Integrada Back Alarm System	
P50.200.147	1	■				
P50.200.148	1		■			
P50.071.100	1	■	■		Kit Conector AMP Repairkit	

NEW

ASPÖCK
IBERICA

www.aspock.com
Catálogo 2022/2023

Piloto trasero LED

LED Rear Combination Lamp

Tipo: 4 FUNCIONES LED 12/24V IP6K9K

Función: Posición LED - Freno LED - Intermitente LED -
Marcha Atrás LED - Antiniebla LED - Reflectante

Function: LED Tail Lamp - LED Stop Lamp - LED Dir. Indicator Lamp -
LED Reversing Lamp - Led Fog lamp - Reflex Reflector

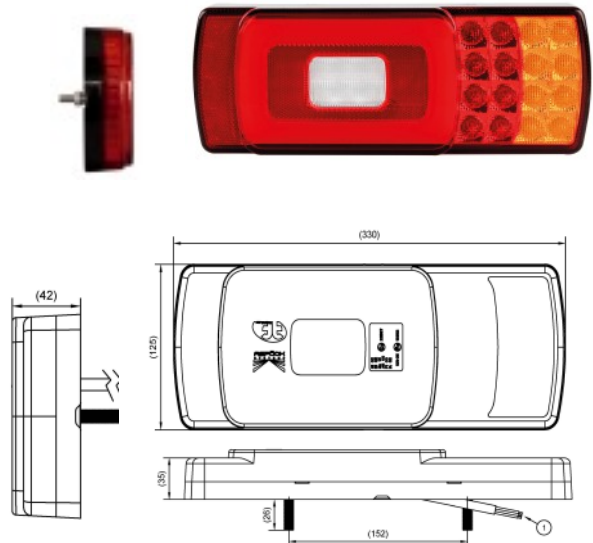



Referencia: Reference-No.	Ud. QTY	Izq. left	Dch. right	Luz Matrícula Numberplate- lamp	Descripción - Referencia O.E. Specification - O.E.-No.	Conector - Accesorios - Recambios Connector - Accessories - Spare Parts
FA41-2010-001 12/24V	1	■	■		Luz de posición con Guía de LED, cable 0,30m <i>LED Tail Lamp in Light guide technology, cable 0,30m</i>	
FA41-2010-011 12/24V	1	■			Luz de posición con Guía de LED, cable 0,3m + conector ASS2 <i>LED Tail Lamp in Light guide technology, cable 0,3m + ASS2 connector</i>	
FA41-2010-021 12/24V	1		■		Luz de posición con Guía de LED, cable 0,3m + conector ASS2 <i>LED Tail Lamp in Light guide technology, cable 0,3m + ASS2 connector</i>	
FA41-2011-001 12/24V	1	■	■		Luz de posición con Guía de LED, cable 0,3m <i>LED Tail Lamp in Light guide technology, cable 0,3m</i>	 SIN ANTINIEBLA
FA41-2011-011 12/24V	1	■	■		Luz de posición con Guía de LED, cable 0,3m + conector ASS2 <i>LED Tail Lamp in Light guide technology, cable 0,3m + ASS2 connector</i>	 SIN ANTINIEBLA
FA41-2011-021 12/24V	1	■	■		Luz de posición con Guía de LED, cable 0,3m + conector ASS2 <i>LED Tail Lamp in Light guide technology, cable 0,3m + ASS2 connector</i>	 SIN ANTINIEBLA

Piloto trasero LED

LED Rear Combination Lamp

Tipo: PRO-STRIPE ECE II

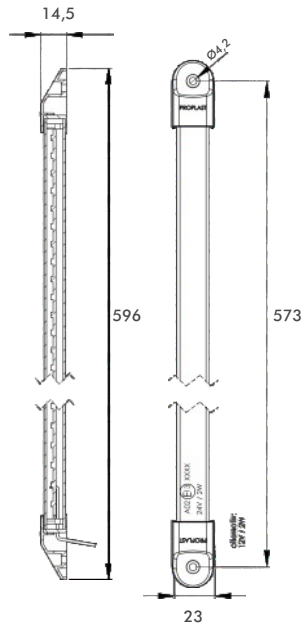

Referencia: Reference-No.	Ud. QTY	Descripción Description	Piloto LED LED Lamps	Tecnología LED LED Technology
P40.052.032 24V	1	Piloto Posición / Freno / Intermitente LED PRO-STRIPE ECE II, Cable 0,5m, luz interior encapsulada en carcasa translúcida, montaje horizontal o vertical, ADR, IP6K9K	 <p>PRO-STRIPE ECE II 596mm</p>	
P40.052.232 12V	1	LED Stop-Tail-Dir. Indicator Lamp PRO-STRIPE ECE II, incl. cable 0,5m, potted version, for horizontal or vertical fixation, ADR-appr. IP6K9K		
P40.052.022 24V	1	Piloto Antiniebla y Marcha Atrás LED PRO-STRIPE ECE II, Cable 0,5m, luz interior encapsulada en carcasa translúcida, montaje horizontal o vertical, ADR, IP6K9K		
P40.052.222 12V	1	LED Fog-/Reversing Lamp PRO-STRIPE ECE II, approved for horizontal and vertical fixation, ADR-appr. IP6K9K, cable 0,5m		
P40.052.042 24V	1	3ª Luz de Freno LED PRO-STRIPE ECE II, Cable 0,5m, 40 Diodos de Alto Rendimiento, luz interior encapsulada en carcasa translúcida, montaje horizontal ADR, IP6K9K		
P40.052.242 12V	1	3rd LED Stop Lamp PRO-STRIPE ECE II, cable 0,5m, 40 LED fitted in a waterproof housing, for horizontal fixation, ADR-appr. IP6K9K		
P40.048.200	1	Kit de Montaje PRO-STRIPE ECE incluye tornillos Mounting Kit PRO-STRIPE ECE incl. screws	 <p>P40.048.200</p>	

NEW

Piloto trasero LED

LED Rear Combination Lamp

Tipo: PRO-THIN-CAN 12/24V IP6K9K

Función: Posición LED - Freno LED - Intermitente LED

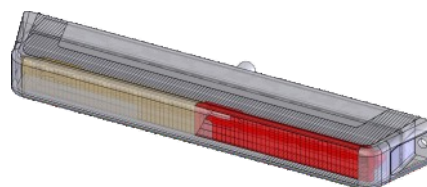

Function: LED Tail Lamp - LED Stop Lamp - LED Dir. Indicator Lamp

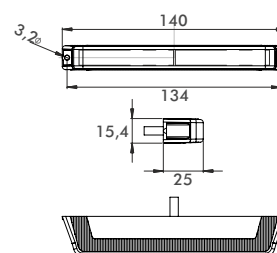

Referencia: Reference-No.	Ud. QTY	Izq. left	Dch. right	Luz Matrícula Numberplate- lamp	Descripción - Referencia O.E. Specification - O.E.-No.	Conector - Accesorios - Recambios Connector - Accessories - Spare Parts
PXX.XXX.XXX	1	■	■		Versión superficie con cable 0,5m <i>version „Black Edition“, cable 0,5m, pendant version</i>	
PXX.XXX.XXY	1	■	■		Versión Antiniebla/ Marcha atrás LED <i>combined LED Fog-/ Reversing Lamp</i>	
P50.140.012 12V	1	■	■		Controlador LED, intermitente - posición- freno - antiniebla- marcha atrás, 2pilotos <i>LED Control Gear monitors the direction indicator lamp and is checking the stop-tail-fog-reversing lamp</i>	 PRO-LCG <i>ver página 9.1.0</i>
P50.140.024 24V	1					
P50.141.012 12V	1	■	■		LED Kontrollgerät Blinklichtfunktion, Blinkerausfallkontrolle <i>LED Control Gear Direction Indicator function</i>	 PRO-CONTROL <i>ver página 9.2.0</i>
P50.141.024 24V	1					
P50.141.500 12/24V	1					
P50.139.012 12V	1	■	■		LED Kontrollgerät kontrolliert die 21W Funktionen, Lastwiderstand <i>LED Control Gear monitors the 21W functions</i>	 PRO-LOAD <i>ver página 9.1.0</i>
P50.139.024 24V	1					
P50.125.512 12V	1	■	■		Control LED Para luces posición <i>LED Control Gear Tail Light function</i>	 <i>ver página 9.2.0</i>
P50.125.524 24V	1					

Piloto trasero LED

LED Rear Combination Lamp

Tipo: PRO-SPACE 3F IP6K9K

Función: Posición LED - Frenos LED - Intermitente LED
Libre posición de montaje sobre el eje

Function: LED Tail Lamp - LED Stop Lamp - LED Dir. Indicator
Lamp mounting free rotated about the reference axis

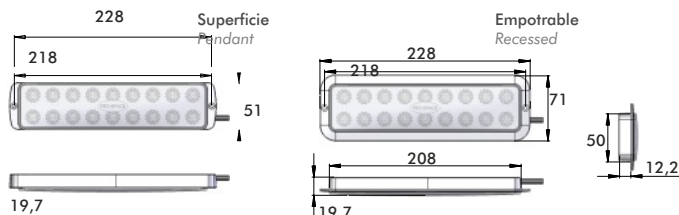

Referencia: Reference-No.	Ud. QTY	Izq. left	Dch. right	Luz Matrícula Numberplate- lamp	Descripción - Referencia O.E. Specification - O.E.-No.	Conector - Accesorios - Recambios Connector - Accessories - Spare Parts
P40.047.412	1	■	■		Versión SUPERFICIE "black edition" Cable 0,8m, 12/24V Montaje horizontal o vertical version PENDANT cable 0,5m, 12/24V	
P40.047.012	1	■	■		Versión SUPERFICIE Cable 0,8m, 12/24V Montaje horizontal o vertical version PENDANT cable 0,5m, 12/24V	
P40.047.512	1	■	■		Versión EMPOTRABLE Cable 0,8m, 12/24V Montaje horizontal o vertical version RECESSED cable 0,5m, 12/24V	
P40.047.711	1	■			Versión SUPERFICIE Cable 0,8m, 12/24V Intermitente SECUENCIAL combined LED Fog-/ Reversing Lamp	
P40.047.712	1		■		Versión SUPERFICIE Cable 0,8m, 12/24V Intermitente SECUENCIAL combined LED Fog-/ Reversing Lamp	
P50.140.012 12V	1	■	■		Controlador LED, intermitente - posición- freno - antiniebla- marcha atrás, 2pilotos	+ info. página 9.0.0 PRO-LCG
P50.140.024 24V	1				LED Control Gear monitors the direction indicator lamp and is checking the stop-tail-fog- reversing lamp	see page 9.0.0
P50.141.012 12V	1	■	■		Controlador LED especial Intermitente	+ info. página 9.0.0 PRO-CONTROL
P50.141.024 24V	1	■	■		LED Control Gear Direction Indicator function	see page 9.3.0

Piloto trasero LED





LED Rear Combination Lamp

Tipo: PRO-CAN XL 3F IP67

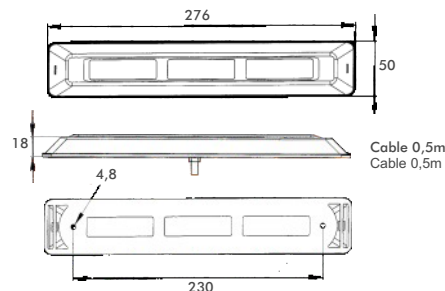
Función: Luz posición LED - Luz freno LED - Intermitente LED -
Con carcasa de fijación
Fijación Horizontal o Vertical

Function: LED Tail Lamp - LED Stop Lamp - LED Dir. Indicator
Lamp -
Fixation housing



Referencia: Reference-No.	Ud. QTY	Izg. left	Dch. right	Luz Matrícula Numberplate- lamp	Descripción - Referencia O.E. Specification - O.E.-No.	Conector - Accesorios - Recambios Connector - Accessories - Spare Parts
P40.026.142 24V	1				Versión con cable 0,5m, 2,2W, incluye carcasa cromada.	
P40.026.942 12V	1	■	■		version cable 0,5m, 2,2W, including chrome housing	
P40.026.542 24V	1				Versión con cable 0,5m, 2,2W, incluye carcasa negra.	
P40.026.642 12V	1	■	■		version cable 0,5m, 2,2W, including black housing	
P40.026.052 24V	1				Versión con cable 0,5m, 2,2W, incluye carcasa cromada, tulipa transparente.	
P40.026.252 12V	1	■	■		version cable 0,5m, 2,2W, including chrome housing, clear lens	
P40.026.742 24V	1				Versión con cable 0,5m, 2,2W, incluye carcasa negra, tulipa transparente.	
P40.026.842 12V	1	■	■		version cable 0,5m, 2,2W, including black housing, clear lens	
P40.026.000 cromo/chrome	1				Carcasas para series PRO-CAN XL	
P40.026.004 negro/black	1	■	■		housing for lighting series PRO-CAN XL	
						cromado/chrome blanco/black
Los colores rojo, gris y blanco, bajo pedido.						
The colours red, grey and white on request only!						
						
						rojo/red gris/grey blanco/white

Piloto trasero LED

LED Rear Combination Lamp

Tipo: PRO-CAN XL 3F IP67

Función: Luz posición LED - Luz freno LED - Intermitente LED -
Fijación Horizontal o Vertical

Function: LED Tail Lamp - LED Stop Lamp - LED Dir. Indicator
Lamp

Fixation horizontal or vertical

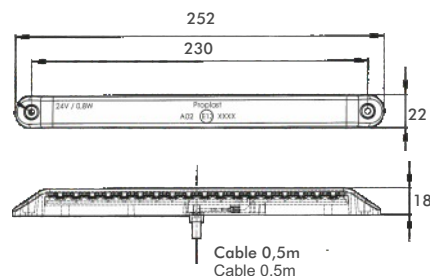
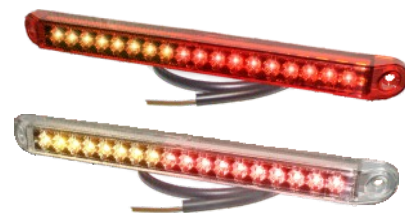

Referencia: Reference-No.	Ud. QTY	Izq. left	Dch. right	Luz Matrícula Numberplate- lamp	Descripción - Referencia O.E. Specification - O.E.-No.	Conector - Accesorios - Recambios Connector - Accessories - Spare Parts
P40.026.042 24V	1	■	■		Versión con cable 0,5m. 24V - 2,2W version cable 0,5m, 24V - 2,2W	
P40.026.242 12V	1	■	■		Versión con cable 0,5m. 12V - 2,2W version cable 0,5m, 12V - 2,2W	
P40.026.442 24V	1	■	■		Versión con cable 0,5m. 24V - 2,2W Tulipa transparente version cable 0,5m, 24V - 2,2W clear housing	
P40.026.342 12V	1	■	■		Versión con cable 0,5m. 12V - 2,2W Tulipa transparente version cable 0,5m, 12V - 2,2W clear housing	
P50.140.012 12V	1	■	■		Controlador LED, intermitente - posición- freno - antiniebla- marcha atrás, 2pilotos	+ info. página 9.0.0 PRO-LCG
P50.140.024 24V	1				LED Control Gear monitors the direction indicator lamp and is checking the stop-tail-fog- reversing lamp	see page 9.0.0
P50.141.012 12V	1	■	■		Controlador LED especial Intermitente	+ info. página 9.0.0 PRO-CONTROL
P50.141.024 24V	1	■	■		LED Control Gear Direction Indicator function	 see page 9.0.0
P50.139.012 12V	1	■	■		Controlador LED funciones 21W	+ info. página 9.3.0 PRO-LOAD
P50.139.024 24V	1	■	■		LED Control Gear monitors the 21W functions	 see page 9.3.0

Piloto trasero LED

LED Rear Combination Lamp

Tipo: PRO-ROAD LG 5F 12/24V IP6K9K

Función: Posición LED - Freno LED - Intermitente LED -
Marcha Atrás LED - Antiniebla LED Reflectante
Montaje horizontal o vertical

Function: LED Tail Lamp - LED Stop Lamp - LED Dir. Indicator
Lamp -
LED Reversing Lamp - LED Fog Lamp - Reflex Reflector
Fixation horizontal or vertical

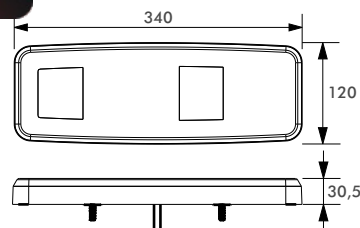

Referencia: Reference-No.	Ud. QTY	Izq. left	Dch. right	Luz Matrícula Numberplate- lamp	Descripción - Referencia O.E. Specification - O.E.-No.	Conector - Accesorios - Recambios Connector - Accessories - Spare Parts
P40.703.012	1	■	■		Posición LED con Tecnología Guía de Led Versión con cable 0,5m LED Tail Lamp in Light guide technology version cable 0,5m	
P40.703.212	1	■	■		Posición LED con Tecnología Guía de Led Versión con conector 7p AMP LED Tail Lamp in Light guide technology version 7-pole AMP connector	
P50.071.100	1	■	■		Kit conector AMP 7P Repair kit	
P50.140.012 12V	1	■	■		Controlador LED, intermitente - posición- freno - antiniebla- marcha atrás, 2pilotos LED Control Gear monitors the direction indicator lamp and is checking the stop-tail-fog- reversing lamp	+ info. página 9.0.0 PRO-LCG
P50.140.024 24V	1					see page 9.0.0
P50.141.012 12V	1	■	■		Controlador LED especial Intermitente LED Control Gear Direction Indicator function	+ info. página 9.0.0 PRO-CONTROL
P50.141.024 24V	1					see page 9.0.0
P50.139.012 12V	1	■	■		Controlador LED funciones 21W LED Control Gear monitors the 21W functions	+ info. página 9.3.0 PRO-LOAD
P50.139.024 24V	1					see page 9.3.0
P50.125.524 24V	1	■	■		Cotrolador LED Para las funciones de posición. LED Control Gear Tail Light function	+ info. página 9.3.0
						see page 9.3.0

Piloto trasero LED

LED Rear Combination Lamp

Tipo: PRO-ROAD LG 12/24V IP6K9K

Función: Luz posición LED - Luz freno LED - Intermitente LED -
Fijación Horizontal o Vertical

Function: LED Tail Lamp - LED Stop Lamp - LED Dir. Indicator
Lamp -

Reflex Reflector
Fixation horizontal or vertical

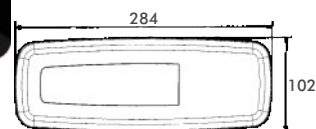

Cable 0,5m
Cable 0,5m



Conector 5-p.
Connector 4-poles



Referencia: Reference-No.	Ud. QTY	Izq. left	Dch. right	Luz Matrícula Numberplate- lamp	Descripción - Referencia O.E. Specification - O.E.-No.	Conector - Accesorios - Recambios Connector - Accessories - Spare Parts
P40.294.012	1	■	■		Luz de posición con Tecnología Guía de LED Versión con cable 0,5m LED Tail Lamp in Light guide technology version cable 0,5m	
P40.294.212	1	■	■		Luz de posición con Tecnología Guía de LED Con conector 5p. LED Tail Lamp in Light guide technology version 5-pole connector	
A13-0546-004	1	■	■		Conector para versión P40.294.212 Connector for version 40 294 212	
P40.057.502	1	■	■	■	Piloto con antiniebla y Luz de marcha atrás LED, Luz de matrícula horizontal combined LED Fog-/ Reversing Lamp with lateral Numberplate Lamp	+ info. página 2.3.0 see page 2.3.0
P50.140.012 12V	1	■	■		Controlador LED, intermitente - posición- freno - antiniebla- marcha atrás, 2pilotos	+ info. página 9.0.0 PRO-LCG see page 9.0.0
P50.140.024 24V	1				LED Control Gear monitors the direction indicator lamp and is checking the stop-tail-fog- reversing lamp	
P50.141.012 12V	1	■	■		Controlador LED especial Intermitente	+ info. página 9.0.0 PRO-CONTROL see page 9.0.0
P50.141.024 24V	1				LED Control Gear Direction Indicator function	
P50.139.012 12V	1	■	■		Controlador LED funciones 21W	+ info. página 9.3.0 PRO-LOAD see page 9.3.0
P50.139.024 24V	1				LED Control Gear monitors the 21W functions	

Piloto trasero LED

LED Rear Combination Lamp

Tipo: PRO-ROAD 12/24V IP6K9K

Función: Posición LED - Frenos LED - Intermitente LED
Reflectante

Function: LED Tail Lamp - LED Stop Lamp - LED Dir. Indicator
Lamp -
Reflex Reflector

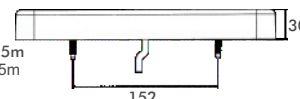
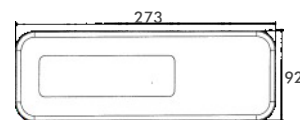

Cable 0,5m
Cable 0,5m

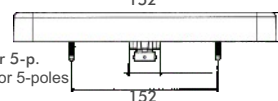

Conector 5-p.
Connector 5-poles



Referencia: Reference-No.	Ud. QTY	Izq. left	Dch. right	Luz Matrícula Numberplate- lamp	Descripción - Referencia O.E. Specification - O.E.-No.	Conector - Accesorios - Recambios Connector - Accessories - Spare Parts
P40.288.012	1	■	■		Versión con Cable 0,5m version cable 0,5m	
P40.288.212	1	■	■		Versión con Conector 5p. Version with connector 5-poles	
A13-0546-004	1	■	■		Conector para el piloto P40.288.212 Connector for version P40.288.212	
P40.288.002	1	■	■		Combinación Antiniebla/ Marcha atrás LED combined LED Fog-/ Reversing Lamp	+ info. página 2.3.0 see page 2.3.0
P50.140.012 12V	1	■	■		Controlador LED, intermitente - posición- freno - antiniebla- marcha atrás, 2pilotos	+ info. página 9.0.0 see page 9.0.0 PRO-LCG
P50.140.024 24V	1	■	■		LED Control Gear monitors the direction indicator lamp and is checking the stop-tail-fog- reversing lamp	
P50.141.012 12V	1	■	■		Controlador LED especial Intermitente	+ info. página 9.0.0 PRO-CONTROL see page 9.0.0
P50.141.024 24V	1	■	■		LED Control Gear Direction Indicator function	
P50.139.012 12V	1	■	■		Controlador LED funciones 21W	+ info. página 9.3.0 see page 9.3.0 PRO-LOAD
P50.139.024 24V	1	■	■		LED Control Gear monitors the 21W functions	

Piloto trasero LED

LED Rear Combination Lamp

Tipo: PRO-M-ROAD 12/24V IP6K9K

Función: Posición LED - Freno LED - Intermitente LED



Function: LED Tail Lamp - LED Stop Lamp - LED Dir. Indicator Lamp

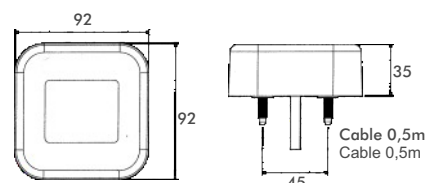

Referencia: Reference-No.	Ud. QTY	Izq. left	Dch. right	Luz Matrícula Numberplate- lamp	Descripción - Referencia O.E. Specification - O.E.-No.	Conector - Accesorios - Recambios Connector - Accessories - Spare Parts
P40.288.001	1	■	■		Versión con cable 0,5m version cable 0,5m	
P40.288.201	1	■	■		Versión con cable 0,2m + Conector 5p. Version with cable 0,2m + connector 5-poles	
A13-0546-004	1	■	■		Conector para Versión P40.288.201 Connector for version 40 288 201	
P40.288.002	1	■	■		Combinación Antiniebla / Marcha atrás LED combined LED Fog-/ Reversing Lamp	+ info. página 2.3.0 see page 2.3.0
P50.140.012 12V	1	■	■		Controlador LED, intermitente - posición- freno - antiniebla- marcha atrás, 2pilotos	+ info. página 9.0.0 PRO-LCG
P50.140.024 24V	1	■	■		LED Control Gear monitors the direction indicator lamp and is checking the stop-tail-fog- reversing lamp	see page 9.0.0
P50.141.012 12V	1	■	■		Controlador LED especial Intermitente	+ info. página 9.0.0 PRO-CONTROL
P50.141.024 24V	1	■	■		LED Control Gear Direction Indicator function	see page 9.0.0
P50.139.012 12V	1	■	■		Controlador LED funciones 21W	+ info. página 9.3.0 PRO-LOAD
P50.139.024 24V	1	■	■		LED Control Gear monitors the 21W functions	see page 9.3.0

Piloto trasero LED

LED Rear Combination Lamp





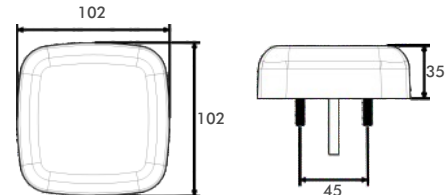

Tipo: PRO-SQUARE LG 12/24V IP6K9K

Función: Posición LED - Freno LED



Function: LED Tail Lamp - LED Stop Lamp



Referencia: Reference-No.	Ud. QTY	Izq. left	Dch. right	Luz Matrícula Numberplate- lamp	Descripción - Referencia O.E. Specification - O.E.-No.	Conector - Accesorios - Recambios Connector - Accessories - Spare Parts
P40.057.032	1	■	■		Luz de posición con Guía de Luz LED Versión con cable 0,5m LED Tail Lamp in Light guide technology version cable 0,5m	
P40.057.001	1	■	■		Intermitente LED LED Dir. Indicator Lamp	
P40.057.002	1	■	■		Antiniebla / Marcha atrás LED combined LED Fog-/ Reversing Lamp	
P40.057.502	1	■	■	■ lateral/ lateral	Antiniebla / Marcha atrás LED, LED Fog-/Reversing Lamp with	
P40.057.602	1	■	■	■ abajo/ below	Antiniebla / Marcha atrás LED, luz de matrícula abajo LED Fog-/Reversing Lamp with Numberplate Lamp	
P40.057.911	1	■	■		Intermitente frontal LED/ luz de posición front LED Dir. Indicator-/ Position Lamp	
P50.140.012 12V	1	■	■		Controlador LED, intermitente - posición- freno - antiniebla- marcha atrás, 2pilotos	+ info. página 9.0.0 PRO-LCG 
P50.140.024 24V	1				LED Control Gear monitors the direction indicator lamp and is checking the stop-tail-fog- reversing lamp	see page 9.0.0

NEW

ASPÖCK
IBERICA

PROPLAST
FAHRZEUGBELEUCHTUNG
www.aspock.com
Catálogo 2022/2023

Página 1.14.1

Piloto trasero LED

LED Rear Combination Lamp

Tipo: PRO-SQUARE 3F 12V

Función: Posición LED - Freno LED - Intermitente LED
Marcha Atrás LED
12V Unidad Control Intermitente
Montaje horizontal o vertical

Function: LED Tail Lamp - LED Stop Lamp - LED Dir. Indicator Lamp
LED Number Plate Lamp
12V Flasher control unit
Fixation horizontal or vertical

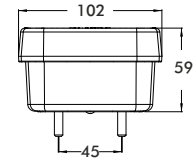
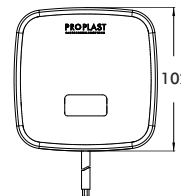

Referencia: Reference-No.	Ud. QTY	Izq. left	Dch. right	Luz Matrícula Numberplate- lamp	Descripción - Referencia O.E. Specification - O.E.-No.	Conector - Accesorios - Recambios Connector - Accessories - Spare Parts
P40.057.012 12V 	1	■	■		Luz de posición Guía de LED 12V Unidad control Intermitente Diseño moderno Carcasa: ABS+PC Tulipa: PMMA Conexión: 1,0m puntas abiertas Voltaje: 12 Volt Montaje: horizontal / vertical Homolog.: ECE EMV Intermitente: 12V-2,0W Posición: 12V-1,0W Freno: 12V-1,0W	
P40.057.013 12V 	1	■	■	■	LED Tail Lamp in Light guide technology 12V flasher control unit Housing: ABS+PC Lens: PMMA Cable: 1,0m open end Voltage: 12 Volt Fixation: horizontal / vertical Homologation: ECE approved EMC approved Dir. Indicator: 12V-21,0W Tail: 12V-1,0W Stop: 12V-1,0W	 Luz de Matrícula/ Numberplate Lamp
P40.057.212 12V 	1	■	■		Luz de posición Guía de LED 12V Unidad control Intermitente Diseño moderno Carcasa: ABS+PC Tulipa: PMMA Conexión: Cable 1m + conector 5p. Voltaje: 12 Volt Montaje: horizontal / vertical Homolog.: ECE EMV Intermitente: 12V-2,0W Posición: 12V-1,0W Freno: 12V-1,0W	
P40.057.213 12V 	1	■	■	■	LED Tail Lamp in Light guide technology 12V flasher control unit Housing: ABS+PC Lens: PMMA Cable: 1,0m + 5-poles bajonet Voltage: 12 Volt Fixation: horizontal / vertical Homologation: ECE approved EMC approved Dir. Indicator: 12V-21,0W Tail: 12V-1,0W Stop: 12V-1,0W	 Luz de Matrícula/ Numberplate Lamp

NEW

ASPÖCK
IBERICA

PROPLAST

FAHRZEUGBELEUCHTUNG

www.aspock.com

Catálogo 2022/2023

Piloto trasero LED

LED Rear Combination Lamp

Tipo: PRO-SQUARE 3F 12/24V

Función: Posición LED - Freno LED - Intermitente LED
Marcha Atrás LED

Montaje horizontal o vertical

Function: LED Tail Lamp - LED Stop Lamp - LED Dir. Indicator Lamp
LED Number Plate Lamp

Fixation horizontal or vertical

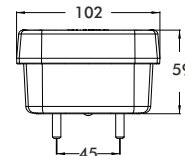
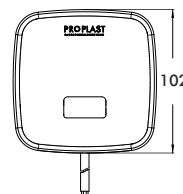

Referencia: Reference-No.	Ud. QTY	Izq. left	Dch. right	Luz Matrícula Numberplate- lamp	Descripción - Referencia O.E. Specification - O.E.-No.	Conector - Accesorios - Recambios Connector - Accessories - Spare Parts
P40.057.512 12/24V	1	■	■		Luz de posición Guía de LED Diseño moderno Carcasa: ABS+PC Tulipa: PMMA Conexión: Cable 1,0m Voltaje: 12/24 Volt Montaje: horizontal / vertical Homolog.: ECE EMV Intermitente: 12V-2,0W / 24V-2,0W Posición: 12V-1,0W / 24V-1,0W Freno: 12V-1,0W / 24V-1,0W	
P40.057.513 12/24V	1	■	■	■	LED Tail Lamp in Light guide technology Housing: ABS+PC Lens: PMMA Cable: 1,0m open end Voltage: 12/24 Volt Fixation: horizontal / vertical Homologation: ECE approved EMC approved Dir. Indicator: 12V-2,0W / 24V-2,0W Tail: 12V-1,0W / 24V-1,0W Stop: 12V-1,0W / 24V-1,0W	 Luz de Matrícula/ Numberplate Lamp

Piloto trasero LED

LED Rear Combination Lamp

Tipo: PRO-BOX 12/24V IP6K9K

Función: Posición LED - Frenos LED - Intermitente LED
Reflectante

Function: LED Tail Lamp - LED Stop Lamp - LED Dir. Indicator
Lamp -
Reflex Reflector

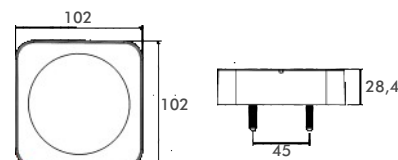

Referencia: Reference-No.	Ud. QTY	Izq. left	Dch. right	Luz Matrícula Numberplate- lamp	Descripción - Referencia O.E. Specification - O.E.-No.	Conector - Accesorios - Recambios Connector - Accessories - Spare Parts
P40.282.012	1	■	■		Versión con cable 0,5m version cable 0,5m	
P40.282.013	1	■	■	■ abajo/ below	Versión con cable 0,5m version cable 0,5m	
P40.282.014	1	■	■	■ lateral/ lateral	Versión con cable 0,5m version cable 0,5m	
P40.282.212	1	■	■		Versión con cable 0,5m + Conector 5p. Version with cable 0,5m + connector 5-poles,	
P50.140.012 12V	1	■	■		Controlador LED, intermitente - posición- freno - antiniebla- marcha atrás, 2pilotos	+ info. página 9.0.0 PRO-LCG
P50.140.024 24V	1				LED Control Gear monitors the direction indicator lamp and is checking the stop-tail-fog- reversing lamp	see page 9.0.0
P50.140.212 12V	1	■	■		Controlador LED pre-montado supervisa el intermitente y comprueba las luces de posición-freno-niebla-luz de marcha atrás LED. Pre-assembled LED Control Kit monitors the direction indicator lamp and is checking the stop- tail-fog-reversing lamp	+ info. página 9.2.0 PRO-LCG
P50.141.212 12V	1	■	■		Control de LED Pre-montado supervisa Intermitente, con cable de 0,3m + conector 5P. Pre-assembled LED Control Gear monitors Dir. Indicator function, cable 0,3m + 5-pole.	+ info. página 9.2.0 PRO-CONTROL

Piloto trasero LED

LED Rear Combination Lamp

Tipo: PRO-AGRILED 10-30V

Función: Posición LED - Freno LED - Intermitente LED
Reflectante

Function: LED Tail Lamp - LED Stop Lamp - LED Dir. Indicator
Lamp -
Reflex Reflector

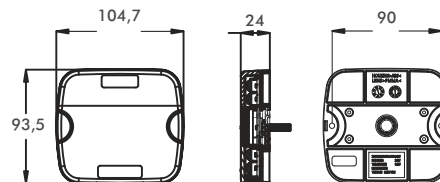

Referencia: Reference-No.	Ud. QTY	Izq. left	Dch. right	Luz Matrícula Numberplate- lamp	Descripción - Referencia O.E. Specification - O.E.-No.	Conector - Accesorios - Recambios Connector - Accessories - Spare Parts
P40.055.001	1	■	■		Versión con Cable 0,5m version cable 0,5m	
P40.055.003	1	■	■	■	Versión con Cable 0,5m version cable 0,5m	
P40.055.201	1	■	■		Versión con Cable 0,5m + conector 5p. version cable 0,5m + 5-pole bayonet connector	
P40.055.203	1	■	■	■	Versión con Cable 0,5m + conector 5p. version cable 0,5m + 5-pole bayonet connector	
P50.140.212 12V	1	■	■		Controlador LED pre-montado supervisa el intermitente y comprueba las luces de posición-freno-niebla-luz de marcha atrás LED. Pre-assembled LED Control Kit monitors the direction indicator lamp and is checking the stop-tail- fog-reversing lamp	+ info. página 9.2.0 see page 9.2.0

Posibilidades de ajuste con la centralita de control LED:
Plug & Play PRO-AGRILED

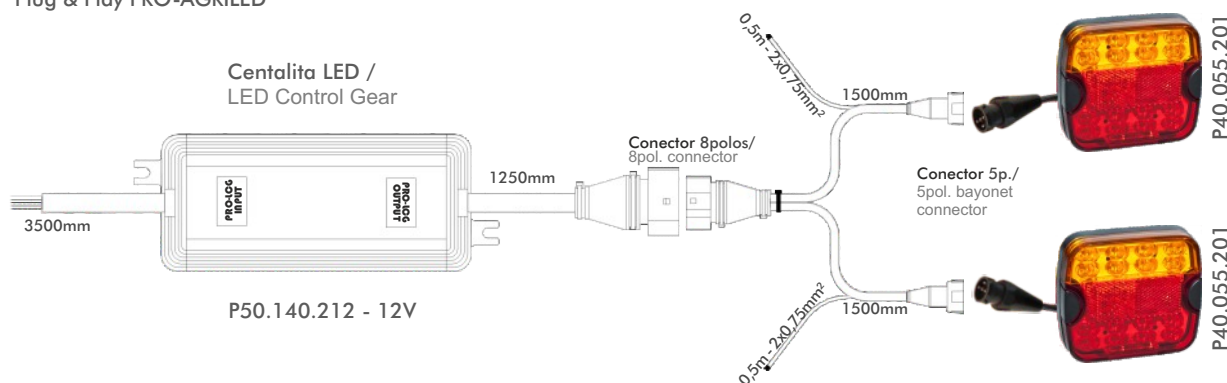

Fitting possibilities with LED Control Gear:
Plug 'n Play PRO-AGRILED

Piloto trasero LED

LED Rear Combination Lamp



Tipo: 3 funciones LED 9-33V

Función: Posición LED - Freno LED - Intermitente LED
Reflectante

Function: LED Tail Lamp - LED Stop Lamp - LED Dir. Indicator
Lamp -
Reflex Reflector

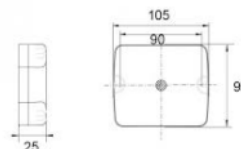

Referencia: Reference-No.	Ud. QTY	Izq. left	Dch. right	Luz Matrícula Numberplate- lamp	Descripción - Referencia O.E. Specification - O.E.-No.	Conector - Accesorios - Recambios Connector - Accessories - Spare Parts
FA41-1331-001	1	■	■	■	Luz de Posición, Freno e Intermitente Led, Cable 0,5m IP67, EMC, 9/33V Tail position lamp, Stop light, Direction indicator, cable 0,5m IP67, EMC, 9/33V	

Tipo: 3 funciones LED 12V

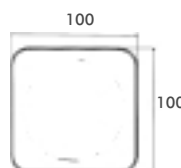

Referencia: Reference-No.	Ud. QTY	Izq. left	Dch. right	Luz Matrícula Numberplate- lamp	Descripción - Referencia O.E. Specification - O.E.-No.	Conector - Accesorios - Recambios Connector - Accessories - Spare Parts
FA41-1384-011	1	■	■		Luz de Posición Led, Freno Led, Intermitencia Led, Reflectante Cable 1m, IP65, 12V Tail position lamp, Stop light, Direction indicator, cable 1m Reflex reflector, IP65, 12V	

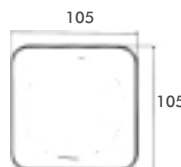

Referencia: Reference-No.	Ud. QTY	Izq. left	Dch. right	Luz Matrícula Numberplate- lamp	Descripción - Referencia O.E. Specification - O.E.-No.	Conector - Accesorios - Recambios Connector - Accessories - Spare Parts
FA41-1384-021	1	■	■	■	Luz de Posición Led, Freno Led, Interm. Led, Cab. 1m, IP65, 12V Tail position lamp, Stop light, Dir.indicator, c.1m, IP65, 12V	
FA41-1384-031	1	■	■		Luz de Posición Led, Freno Led, Interm. Led, Cab. 1m, IP65, 12V Tail position lamp, Stop light, Dir.indicator, c.1m, IP65, 12V	

Piloto trasero LED

LED Rear Combination Lamp

Tipo: PRO-AGRILED II 12V

Función: Posición LED - Freno LED - Intermitente LED
Reflectante
Unidad de control LED integrada

Function: LED Tail Lamp - LED Stop Lamp - LED Dir. Indicator
Lamp -
Reflex Reflector
integrated flasher control unit

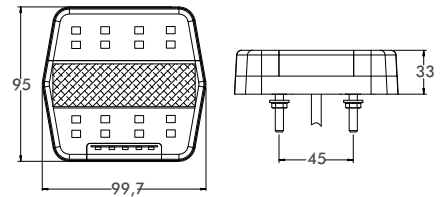

Referencia: Reference-No.	Ud. QTY	Izq. left	Dch. right	Luz Matrícula Numberplate- lamp	Descripción - Referencia O.E. Specification - O.E.-No.	Conector - Accesorios - Recambios Connector - Spare Parts
P40.059.001	1	■	■		Versión con cable 0,5m CONTROLADOR LED INTEGRADO version cable 0,5m	
P40.059.003	1	■	■	■	Versión con cable 0,5m CONTROLADOR LED INTEGRADO version cable 0,5m	
P40.059.201	1	■	■		Versión con cable 0,5m + conector 5-p CONTROLADOR LED INTEGRADO version cable 0,5m + 5-pole bayonet connector	
P40.059.203	1	■	■	■	Versión con cable 0,5m + conector 5-p CONTROLADOR LED INTEGRADO version cable 0,5m + 5-pole bayonet connector	
A13-0546-004	1	■	■		Kit conector Repairkit	

Piloto trasero LED

LED Rear Combination Lamp

Tipo: **PRO-X 10-30V**

Función: Posición LED - Freno LED - Intermitente LED -



Function: LED Tail Lamp - LED Stop Lamp - LED Dir. Indicator Lamp -

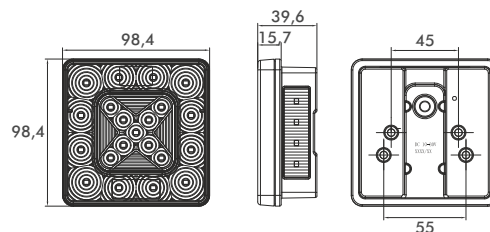

Referencia: Reference-No.	Ud. QTY	Izq. left	Dch. right	Luz Matrícula Numberplate- lamp	Descripción - Referencia O.E. Specification - O.E.-No.	Conector - Accesorios - Recambios Connector - Accessories - Spare Parts
P40.081.012	1	■	■		Versión cable 1,0m version cable 1,0m	
P40.081.013	1	■	■	■	Versión cable 1,0m version cable 1,0m	
P50.140.012 12V	1	■	■		Controlador LED, intermitente - posición- freno - antiniebla- marcha atrás, 2pilotos LED Control Gear monitors the direction indicator lamp and is checking the stop-tail-fog- reversing lamp	PRO-LCG
P50.140.024 24V	1					ver página 9.1
P50.141.012 12V	1				Controlador LED especial Intermitente LED Control Gear Direction Indicator function	PRO-CONTROL
P50.141.024 24V	1	■	■			ver página 9.9
P50.141.500 12/24V	1					
P50.139.012 12V	1	■	■		Controlador LED funciones 21W LED Control Gear monitors the 21W functions	PRO-LOAD
P50.139.024 24V	1					ver página 9.10
P50.125.512 12V	1	■	■		Control LED Para luces posición LED Control Gear Tail Light function	PRO-M-LOAD
P50.125.524 24V	1					ver página 9.1

Piloto trasero LED

LED Rear Combination Lamp

Tipo: PRO-HORIZONTAL 12/24V IP6K9K





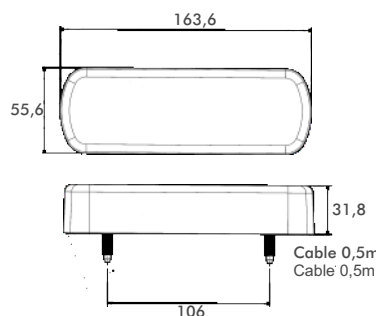

Función: Posición LED - Freno LED - Intermitente LED -
 opcional Marcha atrás
 Fijación horizontal

Function: LED Tail Lamp - LED Stop Lamp - LED Dir. Indicator
 Lamp -
 opt. Reversing Lamp
 Fixation horizontal

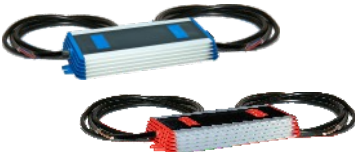

P40.287.001 P40.287.003



Referencia: Reference-No.	Ud. QTY	Izq. left	Dch. right	Marcha Atrás Reversing lamp	Descripción - Referencia O.E. Specification - O.E.-No.	Conector - Accesorios - Recambios Connector - Accessories - Spare Parts
P40.287.001	1	■	■		Versión con cable 0,5m version cable 0,5m	
P40.287.003	1	■	■	■	Versión con cable 0,5m version cable 0,5m	
P50.140.012 12V	1	■	■		Controlador LED, intermitente - posición- freno - antiniebla- marcha atrás, 2pilotos	+ info. página 9.0.0 PRO-LCG 
P50.140.024 24V	1				LED Control Gear monitors the direction indicator lamp and is checking the stop-tail-fog- reversing lamp	see page 9.0.0
P50.141.012 12V	1	■	■		Controlador LED especial Intermitente	+ info. página 9.0.0 PRO-CONTROL 
P50.141.024 24V	1				LED Control Gear Direction Indicator function	see page 9.0.0
P50.139.012 12V	1	■	■		Controlador LED funciones 21W	+ info. página 9.3.0 PRO-LOAD 
P50.139.024 24V	1				LED Control Gear monitors the 21W functions	see page 9.3.0
P50.125.524 24V	1	■	■		Cotrolador LED Para las funciones de posición. LED Control Gear Tail Light function	+ info. página 9.3.0  see page 9.3.0

Piloto trasero LED

LED Rear Combination Lamp

Tipo: PRO-VERTICAL 12/24V IP6K9K

Función: Posición LED - Freno LED - Intermitente LED -
opcional Marcha atrás
Fijación vertical

Function: LED Tail Lamp - LED Stop Lamp - LED Dir. Indicator
Lamp -
opt. Reversing Lamp
Fixation vertical

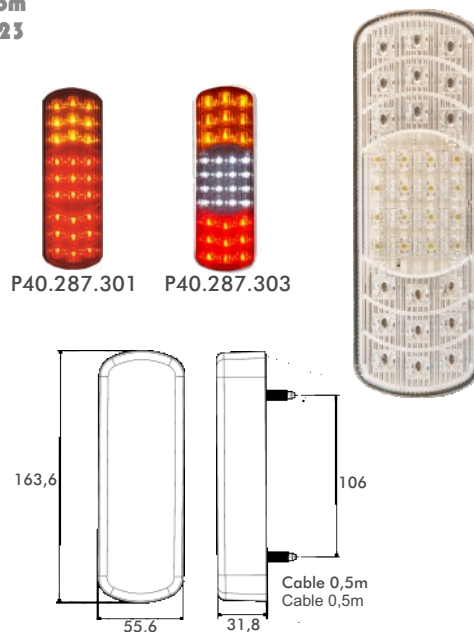

Referencia: Reference-No.	Ud. QTY	Izq. left	Dch. right	Marcha Atrás Reversing lamp	Descripción - Referencia O.E. Specification - O.E.-No.	Conector - Accesorios - Recambios Connector - Accessories - Spare Parts
P40.287.301	1	■	■		Versión con Cable 0,5m version cable 0,5m	
P40.287.303	1	■	■	■	Versión con Cable 0,5m version cable 0,5m	
P50.140.012 12V	1	■	■		Controlador LED, intermitente - posición- freno - antiniebla- marcha atrás, 2pilotos	+ info. página 9.0.0 PRO-LCG
P50.140.024 24V	1				LED Control Gear monitors the direction indicator lamp and is checking the stop-tail-fog- reversing lamp	see page 9.0.0
P50.141.012 12V	1	■	■		Controlador LED especial Intermitente	+ info. página 9.0.0 PRO-CONTROL
P50.141.024 24V	1				LED Control Gear Direction Indicator function	see page 9.0.0
P50.139.012 12V	1	■	■		Controlador LED funciones 21W	+ info. página 9.3.0 PRO-LOAD
P50.139.024 24V	1				LED Control Gear monitors the 21W functions	see page 9.3.0
P50.125.524 24V	1	■	■		Cotrolador LED Para las funciones de posición.	+ info. página 9.3.0
	1				LED Control Gear Tail Light function	see page 9.3.0

Piloto trasero LED

LED Rear Combination Lamp

Tipo: 3-Funciones 12/24V IP6K9K

Función: Posición LED - Freno LED - Intermitente LED -
Reflectante

Function: LED Tail Lamp - LED Stop Lamp - LED Dir. Indicator
Lamp -
Reflex Reflector

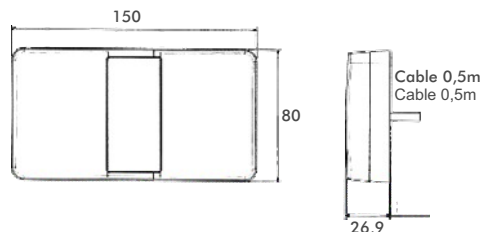

Referencia: Reference-No.	Ud. QTY	Izq. left	Dch. right	Luz Matrícula Numberplate- lamp	Descripción - Referencia O.E. Specification - O.E.-No.	Conector - Accesorios - Recambios Connector - Accessories - Spare Parts
P40.277.012	1	■	■		Versión con Cable 0,5m version cable 0,5m	
P50.140.012 12V	1	■	■		Controlador LED, intermitente - posición- freno - antiniebla- marcha atrás, 2pilotos	+ info. página 9.0.0 PRO-LCG
P50.140.024 24V	1				LED Control Gear monitors the direction indicator lamp and is checking the stop-tail-fog- reversing lamp	see page 9.0.0
P50.141.012 12V	1	■	■		Controlador LED especial Intermitente	+ info. página 9.0.0 PRO-CONTROL
P50.141.024 24V	1				LED Control Gear Direction Indicator function	see page 9.0.0
P50.139.012 12V	1	■	■		Controlador LED funciones 21W	+ info. página 9.3.0 PRO-LOAD
P50.139.024 24V	1				LED Control Gear monitors the 21W functions	see page 9.3.0
P50.125.524 24V	1	■	■		Cotrolador LED Para las funciones de posición. LED Control Gear Tail Light function	+ info. página 9.3.0
						see page 9.3.0

Piloto trasero LED

LED Rear Combination Lamp

Tipo: 3-Funciones 12/24V IP6K9K

Función: Posición LED - Freno LED - Intermitente LED -
Reflectante

Function: LED Tail Lamp - LED Stop Lamp - LED Dir. Indicator
Lamp -
Reflex Reflector

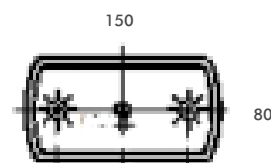

Referencia: Reference-No.	Ud. QTY	Izq. left	Dch. right	Luz Matrícula Numberplate- lamp	Descripción - Referencia O.E. Specification - O.E.-No.	Conector - Accesorios - Recambios Connector - Accessories - Spare Parts
FA41-1394-011	1	■	■		Versión con Cable 0,5m version cable 0,5m	

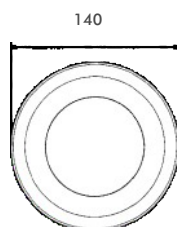

Referencia: Reference-No.	Ud. QTY	Izq. left	Dch. right	Luz Matrícula Numberplate- lamp	Descripción - Referencia O.E. Specification - O.E.-No.	Conector - Accesorios - Recambios Connector - Accessories - Spare Parts
FA41-2000-001	1	■	■		Versión con Cable 0,5m version cable 0,5m	
FA41-2000-011	1	■	■		Versión cable 0.5m y conector Superseal 4p version cable 0,5m 4p connector Superseal	

NEW



PROPLAST

FAHRZEUGBELEUCHTUNG

www.aspock.com

Catálogo 2022/2023

Piloto trasero LED

LED Rear Combination Lamp

Tipo: PRO-LOOP 12/24V

Función: 2 Luz PosiciónLED - 2 Freno LED - Intermitente secuencial LED

Function: 2 x LED Tail Lamp - 2 x LED Stop Lamp - sequential LED Dir. Indicator Lamp



Referencia: Reference-No.	Ud. QTY	Izq. left	Dch. right	Luz Matrícula Numberplate- lamp	Descripción - Referencia O.E. Specification - O.E.-No.	Conector - Accesorios - Recambios Connector - Accessories - Spare Parts
P40.202.991 Anillo exterior Cromado body ring chrome	1	■			Mayor protección debido a su bajo perfil Diseño Moderno Intermitente Secuencial Doble Luz de Posición Doble Luz de Freno Carcasa: ABS Tulipa: PMMA Anillo: ABS Conexión: 0,5m offenes Ende Voltaje: 12/24 Volt Protección: IP6K9K Homolog.: ECE ADR EMV Intermitente: 12V-1,9W / 24V-1,9W Posición: 12V-0,5W / 24V-0,5W Freno: 12V-2,1W / 24V-2,1W	
P40.202.992 Anillo exterior Cromado body ring chrome	1		■			
P40.202.941 Anillo exterior Negro body ring glossy black	1	■			Increased protection thanks to low profile Modern design Sequential Dir. Indicator light Double Tail light Double Stop light Housing: ABS Lens: PMMA Body ring: ABS Cable: 0,5m open end Voltage: 12/24 Volt Protection: IP6K9K Homologation: ECE approved ADR approved EMC approved Dir. Indicator: 12V-1,9W / 24V-1,9W Tail: 12V-0,5W / 24V-0,5W Stop: 12V-2,1W / 24V-2,1W	
P40.202.942 Anillo exterior Negro body ring glossy black	1		■			
P40.202.951 Anillo exterior Blanco body ring glossy white	1	■				
P40.202.952 Anillo exterior Blanco body ring glossy white	1		■			

NEW



PROPLAST

FAHRZEUGBELEUCHTUNG

www.aspock.com

Catálogo 2022/2023

Piloto trasero LED

LED Rear Combination Lamp

Tipo: PRO-LOOP 12/24V

Función: 2 Luz PosiciónLED - 2 Freno LED - Intermitente LED

Function: 2 x LED Tail Lamp - 2 x LED Stop Lamp - LED Dir. Indicator Lamp



Referencia: Reference-No.	Ud. QTY	Izq. left	Dch. right	Luz Matrícula Numberplate- lamp	Descripción - Referencia O.E. Specification - O.E.-No.	Conector - Accesorios - Recambios Connector - Accessories - Spare Parts
P40.202.791 Anillo exterior Cromado body ring chrome	1	■	■		Mayor protección debido a su bajo perfil Diseño Moderno Doble Luz de Posición Doble Luz de Freno Carcasa: ABS Tulipa: PMMA Anillo: ABS Conexión: 0,5m offenes Ende Voltaje: 12/24 Volt Protección: IP6K9K Homolog.: ECE ADR EMV Intermitente: 12V-1,9W / 24V-1,9W Posición: 12V-0,5W / 24V-0,5W Freno: 12V-2,1W / 24V-2,1W	
P40.202.741 Anillo exterior Negro body ring glossy black	1	■	■		Increased protection thanks to low profile Modern design Double Tail light Double Stop light Housing: ABS Lens: PMMA Body ring: ABS Cable: 0,5m open end Voltage: 12/24 Volt Protection: IP6K9K Homologation: ECE approved ADR approved EMC approved Dir. Indicator: 12V-1,9W / 24V-1,9W Tail: 12V-0,5W / 24V-0,5W Stop: 12V-2,1W / 24V-2,1W	
P40.202.751 Anillo exterior Blanco body ring glossy white	1	■	■			

NEW

ASPÖCK
IBERICA

PROPLAST

FAHRZEUGBELEUCHTUNG

www.aspock.com

Catálogo 2022/2023

Piloto trasero LED

LED Rear Combination Lamp

Tipo: PRO-LOOP 24V

Función: Luz PosiciónLED - Freno LED - Intermitente LED

Function: LED Tail Lamp - LED Stop Lamp - LED Dir. Indicator Lamp



Referencia: Reference-No.	Ud. QTY	Izq. left	Dch. right	Luz Matrícula Numberplate- lamp	Descripción - Referencia O.E. Specification - O.E.-No.	Conector - Accesorios - Recambios Connector - Accessories - Spare Parts
P40.202.891 Anillo exterior Cromado body ring chrome	1	■	■		Mayor protección debido a su bajo perfil Diseño Moderno Luz de Posición Luz de Freno Carcasa: ABS Tulipa: PMMA Anillo: ABS Conexión: 0,5m offenes Ende Voltage: 12/24 Volt Protección: IP6K9K Homolog.: ECE ADR EMV Intermitente: 24V-2,65W Posición: 24V-1,12W Freno: 24V-1,55W	
P40.202.841 Anillo exterior Negro body ring glossy black	1	■	■		Increased protection thanks to low profile Modern design Single Tail light Single Stop light Housing: ABS Lens: PMMA Body ring: ABS Cable: 0,5m open end Voltage: 12/24 Volt Protection: IP6K9K Homologation: ECE approved ADR approved EMC approved Dir. Indicator: 24V-2,65W Tail: 24V-1,12W Stop: 24V-1,55W	
P40.202.851 Anillo exterior Blanco body ring glossy white	1	■	■			

Piloto trasero LED

LED Rear Combination Lamp





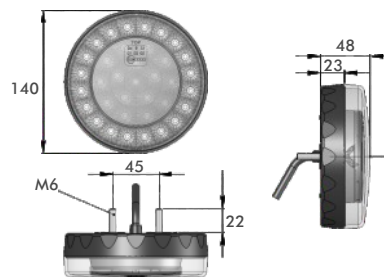

Tipo: PRO-SPOT ECO 12/24V IP6K9K

Función: Posición LED - Freno LED - Intermitente LED



Function: LED Tail Lamp - LED Stop Lamp - LED Dir. Indicator Lamp



Referencia: Reference-No.	Ud. QTY	Izq. left	Dch. right	Luz Matrícula Numberplate- lamp	Descripción - Referencia O.E. Specification - O.E.-No.	Conector - Accesorios - Recambios Connector - Accessories - Spare Parts
P40.019.501	1	■	■		Versión con Cable 0,5m version cable 0,5m	
P40.025.502	1	■	■		Combinación Antiniebla / Marcha atrás LED combined LED Fog-/ Reversing Lamp	+ info. página 2.1.0 see page 2.1.0 
P50.140.012 12V	1	■	■		Controlador LED, intermitente - posición- freno - antiniebla- marcha atrás, 2pilotos LED Control Gear monitors the direction indicator lamp and is checking the stop-tail-fog- reversing lamp	+ info. página 9.0.0 see page 9.0.0  PRO-LCG
P50.141.012 12V	1	■	■		Controlador LED especial Intermitente LED Control Gear Direction Indicator function	+ info. página 9.0.0 see page 9.0.0  PRO-CONTROL
P50.139.012 12V	1	■	■		Controlador LED funciones 21W LED Control Gear monitors the 21W functions	+ info. página 9.3.0 see page 9.3.0  PRO-LOAD
P50.125.524 24V	1	■	■		Controlador LED Para las funciones de posición. LED Control Gear Tail Light function	+ info. página 9.3.0 see page 9.3.0 

Piloto trasero LED

LED Rear Combination Lamp

Tipo: PRO-SPOT ECO 12/24V IP6K9K

Función: Posición LED - Freno LED - Intermitente LED

Function: LED Tail Lamp - LED Stop Lamp - LED Dir. Indicator Lamp

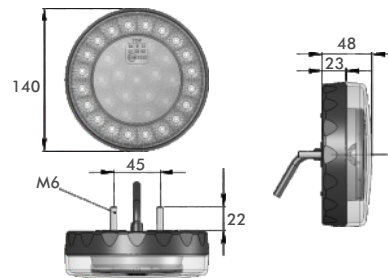
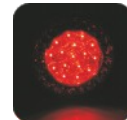

Referencia: Reference-No.	Ud. QTY	Izq. left	Dch. right	Luz Matrícula Numberplate- lamp	Descripción - Referencia O.E. Specification - O.E.-No.	Conector - Accesorios - Recambios Connector - Accessories - Spare Parts
P40.019.521	1	■	■		Versión con Cable 0,5m + conector 7p. AMP version cable 0,5m + 7-pol. AMP connector	
P40.025.522	1	■	■		Combinación Antiniebla / Marcha atrás LED, con cable 0,5m + conector 7p. AMP combined LED Fog-/ Reversing Lamp, cable 0,5m + 7-pol. AMP connector	+ info. página 2.1.0 see page 2.1.0
P50.140.412 12V	1	■	■		Controlador LED pre-montado supervisa el intermitente y comprueba las luces de posición-freno-niebla-luz de marcha atrás LED. Conectores incluidos.	+ info. página 9.1.0 see page 9.1.0
P50.140.424 24V	1				LED Control Gear monitors the direction indicator lamp and is checking the stop-tail-fog-reversing lamp	PRO-LCG

Posibilidades de ajuste con la centralita de control LED:
Plug & Play PRO-SPOT ECO & PRO-SPOT ECO FR

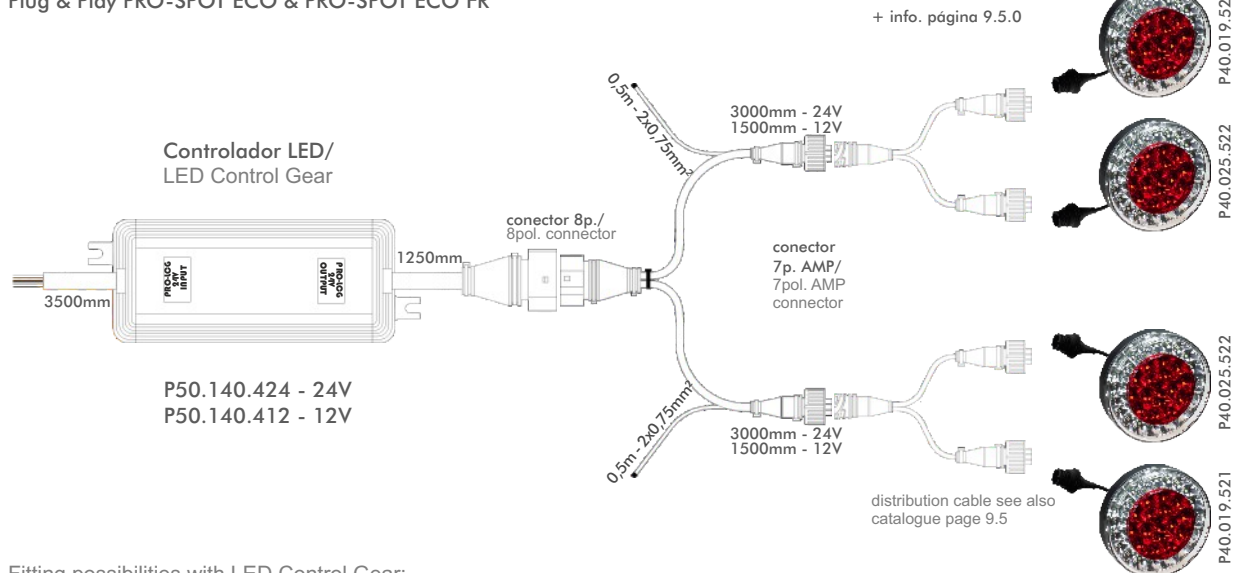

Fitting possibilities with LED Control Gear:
Plug 'n Play PRO-SPOT ECO & PRO-SPOT ECO FR

Piloto trasero LED

LED Rear Combination Lamp

Tipo: PRO-SPOT 10V-30V IP6K9K

Función: Posición LED - Freno LED - Intermitente LED

Function: LED Tail Lamp - LED Stop Lamp - LED Dir. Indicator Lamp

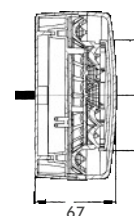
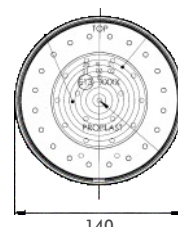

Referencia: Reference-No.	Ud. QTY	Izq. left	Dch. right	Luz Matrícula Numberplate- lamp	Descripción - Referencia O.E. Specification - O.E.-No.	Conector - Accesorios - Recambios Connector - Accessories - Spare Parts
P40.019.001	1	■	■		Versión con racor PG posterior version PG-screw	
P40.019.461	1	■	■		Versión con cable 2,0m version cable 2,0m	
P40.025.002	1	■	■		Combinación Antiniebla-/ Marcha atrás LED, versión con rosca PG-Posterior. Fog-/Reversing Lamp version PG-screw	+ info. página 2.1.0 see page 2.1.0
P40.025.462	1	■	■		Combinación Antiniebla-/ Marcha atrás LED, versión con cable 2m. Fog-/Reversing Lamp version cable 2,0m	+ info. página 2.1.0 see page 2.1.0
P40.019.102	1	■	■		Kit marco cromado Built-In Kit chrome	
P50.140.012 12V	1	■	■		Controlador LED, intermitente - posición- freno - antiniebla- marcha atrás, 2pilotos	+ info. página 9.0.0 PRO-LCG
P50.140.024 24V	1	■	■		LED Control Gear monitors the direction indicator lamp and is checking the stop-tail-fog- reversing lamp	 see page 9.0.0

Piloto trasero LED

LED Rear Combination Lamp

Tipo: 3-Funciones LED 24V IP6K9K

Función: Posición LED - Freno LED - Intermitente LED



Function: LED Tail Lamp - LED Stop Lamp - LED Dir. Indicator Lamp

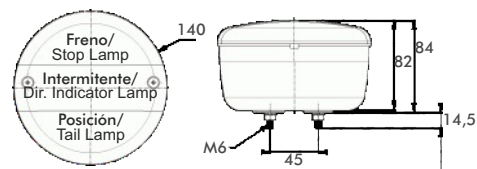

Referencia: Reference-No.	Ud. QTY	Izq. left	Dch. right	Luz Matrícula Numberplate- lamp	Descripción - Referencia O.E. Specification - O.E.-No.	Conector - Accesorios - Recambios Connector - Accessories - Spare Parts
P40.202.801	1	■	■		Versión con cable 0,5m, Homologación D version cable 0,5m, D-Homologation	
P40.202.821	1	■	■		Versión con conector AMP 7-p. Homologación D version 7-pol. AMP con., D-Homologation	
P40.149.202	1	■	■		Combinación Antiniebla-/ Marcha atrás LED combined LED Fog-/ Reversing Lamp	+ info. página 2.5.0 see page 2.5.0
P40.149.402	1	■	■		Antiniebla LED LED Fog Lamp	+ info. página 2.5.0 see page 2.5.0
P40.149.403	1	■	■		Marcha atrás LED LED Reversing Lamp	+ info. página 2.5.0 see page 2.5.0
P50.140.024 24V	1	■	■		Controlador LED, intermitente - posición- freno - antiniebla- marcha atrás, 2pilotos LED Control Gear monitors the direction indicator lamp and is checking the stop-tail-fog- reversing lamp	+ info. página 9.0.0 PRO-LCG see page 9.0.0
P50.141.024 24V	1	■	■		Controlador LED especial Intermitente LED Control Gear Direction Indicator function	+ info. página 9.0.0 PRO-CONTROL see page 9.0.0
P50.139.024 24V	1	■	■		Controlador LED funciones 21W LED Control Gear monitors the 21W functions	+ info. página 9.3.0 PRO-LOAD see page 9.3.0

Piloto trasero LED

LED Rear Combination Lamp

Tipo: 3-Funciones LED 12/24V

Función: Posición LED - Freno LED - Intermitente LED



Function: LED Tail Lamp - LED Stop Lamp - LED Dir. Indicator Lamp

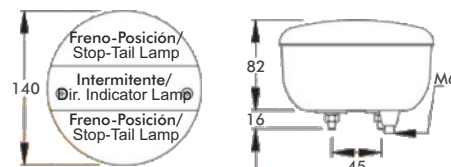

Referencia: Reference-No.	Ud. QTY	Izq. left	Dch. right	Luz Matrícula Numberplate- lamp	Descripción - Referencia O.E. Specification - O.E.-No.	Conector - Accesorios - Recambios Connector - Accessories - Spare Parts
P40.202.601	1	■	■		Versión con pasacables version grommet	
P40.149.402	1	■	■		Antiniebla LED LED Fog Lamp	+ info. página 2.5.0 see page 2.5.0
P40.149.403	1	■	■		Marcha Atrás LED LED Reversing Lamp	+ info. página 2.5.0 see page 2.5.0
P50.140.012 12V	1	■	■		Controlador LED, intermitente - posición- freno - antiniebla- marcha atrás, 2pilotos	+ info. página 9.0.0 PRO-LCG
P50.140.024 24V	1				LED Control Gear monitors the direction indicator lamp and is checking the stop-tail-fog- reversing lamp	see page 9.0.0
P50.141.012 12V	1	■	■		Controlador LED especial Intermitente	+ info. página 9.0.0 PRO-CONTROL
P50.141.024 24V	1	■	■		LED Control Gear Direction Indicator function	see page 9.0.0
P50.139.012 12V	1	■	■		Controlador LED funciones 21W	+ info. página 9.3.0 PRO-LOAD
P50.139.024 24V	1	■	■		LED Control Gear monitors the 21W functions	see page 9.3.0
P50.125.524 24V	1	■	■		Cotrolador LED Para las funciones de posición. LED Control Gear Tail Light function	+ info. página 9.3.0 see page 9.3.0

Piloto trasero LED

LED Rear Combination Lamp

Tipo: 3-Funciones LED 12/24V IP54

Función: Posición LED - Freno LED - Intermitente LED



Function: LED Tail Lamp - LED Stop Lamp - LED Dir. Indicator Lamp

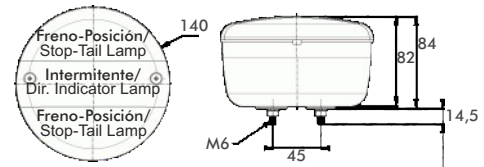

Referencia: Reference-No.	Ud. QTY	Izq. left	Dch. right	Luz Matrícula Numberplate- lamp	Descripción - Referencia O.E. Specification - O.E.-No.	Conector - Accesorios - Recambios Connector - Accessories - Spare Parts
A23-8400-757	1	■	■		Versión Doble Posición LED con pasacables Tail lamp LED x 2, grommet	
A23-8400-807	1	■	■		Versión: 1 Luz de Posición, 1 Luz de Freno version: 1 tail lamp, 1 stop lamp	
A27-8400-707	1	■	■		Antiniebla Versión pasacables Fog Lamp version grommet	+ info. página 2.6.0 see page 2.7.0
A28-8400-707	1	■	■		Marcha Atrás Versión pasacables Reversing Lamp version grommet	+ info. página 2.6.0 see page 2.7.0
P50.140.024 24V	1	■	■		Controlador LED, intermitente - posición- freno - antiniebla- marcha atrás, 2pilotos LED Control Gear monitors the direction indicator lamp and is checking the stop-tail-fog- reversing lamp	+ info. página 9.0.0 PRO-LCG see page 9.0.0

Piloto trasero LED

LED Rear Combination Lamp

Tipo: PRO-CUP

Función: Posición LED - Freno LED - Intermitente LED



Function: LED Tail Lamp - LED Stop Lamp - LED Dir. Indicator Lamp

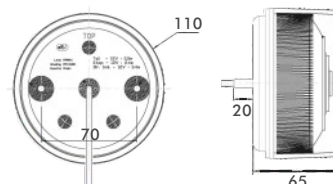

Referencia: Reference-No.	Ud. QTY	Izq. left	Dch. right	Luz Matrícula Numberplate- lamp	Descripción - Referencia O.E. Specification - O.E.-No.	Conector - Accesorios - Recambios Connector - Accessories - Spare Parts
P40.702.201 12V	1	■	■		Versión con Cable 0,5m version cable 0,5m	
P50.140.012 12V	1	■	■		Controlador LED, intermitente - posición- freno - antiniebla- marcha atrás, 2pilotos	+ info. página 9.0.0 PRO-LCG
P50.140.024 24V	1				LED Control Gear monitors the direction indicator lamp and is checking the stop-tail-fog- reversing lamp	see page 9.0.0
P50.141.012 12V	1	■	■		Controlador LED especial Intermitente	+ info. página 9.0.0 PRO-CONTROL
P50.141.024 24V	1				LED Control Gear Direction Indicator function	see page 9.0.0
P50.139.012 12V	1	■	■		Controlador LED funciones 21W	+ info. página 9.3.0 PRO-LOAD
P50.139.024 24V	1				LED Control Gear monitors the 21W functions	see page 9.3.0

Piloto trasero LED



LED Rear Combination Lamp

Tipo: PRO-RING 12/24V

Función: Posición LED - Freno LED - Intermitente LED

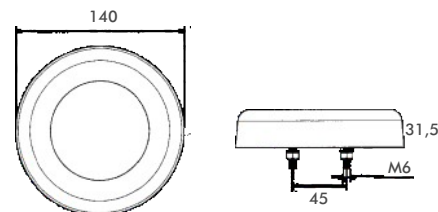
Function: LED Tail Lamp - LED Stop Lamp - LED Dir. Indicator Lamp



Referencia: Reference-No.	Ud. QTY	Izq. left	Dch. right	Luz Matrícula Numberplate- lamp	Descripción - Referencia O.E. Specification - O.E.-No.	Conector - Accesorios - Recambios Connector - Accessories - Spare Parts
P40.051.001	1	■	■		Luz de Posición Guía de LED Versión con Cable 0,5m LED Tail Lamp in Light guide technology version cable 0,5m	
P40.051.201	1	■	■		Luz de Posición Guía de LED Cable 0,5m + conector 7p AMP LED Tail Lamp in Light guide technology version cable 0,5m	
P40.051.002	1	■	■		Combinación Antiniebla/ Marcha Atrás y Luz de Posición Guía de LED, Versión con Cable 0,5m combined LED Fog-/Reversing Lamp, LED Tail Lamp in Light guide techn., version cable 0,5m	
P40.051.201	1	■	■		Combinación Antiniebla/ Marcha Atrás y Luz de Posición Guía de LED, Versión con Cable 0,5m + conector 7p AMP LED Tail Lamp in Light guide technology version cable 0,5m	
P50.140.012 12V	1	■	■		Controlador LED, intermitente - posición- freno - antiniebla- marcha atrás, 2pilotos	 PRO-LCG see page 9.0
P50.140.024 24V	1	■	■		LED Control Gear monitors the direction indicator lamp and is checking the stop-tail-fog- reversing lamp	
P50.141.012 12V	1	■	■		Controlador LED especial Intermitente	 PRO-CONTROL see page 9.3.0
P50.141.024 24V	1	■	■		LED Control Gear Direction Indicator function	
P50.125.524 24V	1	■	■		Cotrolador LED Para las funciones de posición. LED Control Gear Tail Light function	 see page 9.3.0

Piloto trasero LED

LED Rear Combination Lamp

Tipo: PRO-MINI-RING 12/24V IP6K9K

Función: Posición LED - Freno LED
Versión Superficie

Function: LED Tail Lamp - LED Stop Lamp
Pendant version

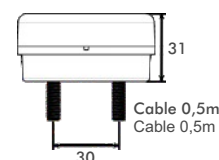
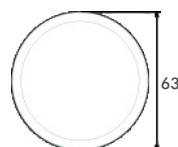

Referencia: Reference-No.	Ud. QTY	Izq. left	Dch. right	Luz Matrícula Numberplate- lamp	Descripción - Referencia O.E. Specification - O.E.-No.	Conector - Accesorios - Recambios Connector - Accessories - Spare Parts
P40.054.032	1	■	■		Luz de Posición Guía de Led versión con Cable 0,5m LED Tail Lamp in Light guide technology version cable 0,5m	
P40.054.001	1	■	■		Intermitente LED LED Dir. Indicator Lamp	+ info. página 2.11.0 see page 2.11.0
P40.054.022	1	■	■		Antiniebla LED LED Fog Lamp	+ info. página 2.5.0 see page 2.5.0
P40.054.003	1	■	■		Marcha Atrás LED LED Reversing Lamp	+ info. página 2.5.0 see page 2.5.0
P50.140.012 12V	1	■	■		Controlador LED, intermitente - posición- freno - antiniebla- marcha atrás, 2pilotos	+ info. página 9.0.0 PRO-LCG
P50.140.024 24V	1				LED Control Gear monitors the direction indicator lamp and is checking the stop-tail-fog- reversing lamp	see page 9.0.0
P50.141.012 12V	1	■	■		Controlador LED especial Intermitente	+ info. página 9.0.0 PRO-CONTROL
P50.141.024 24V	1				LED Control Gear Direction Indicator function	see page 9.0.0
P50.139.012 12V	1	■	■		Controlador LED funciones 21W	+ info. página 9.3.0 PRO-LOAD
P50.139.024 24V	1				LED Control Gear monitors the 21W functions	see page 9.3.0
P50.125.524 24V	1	■	■		Cotrolador LED Para las funciones de posición. LED Control Gear Tail Light function	+ info. página 9.3.0 see page 9.3.0

Piloto trasero LED

LED Rear Combination Lamp

Tipo: PRO-MINI-RING 12/24V IP6K9K

Función: Posición LED - Freno LED
Versión empotrable

Function: LED Tail Lamp - LED Stop Lamp
Recessed version

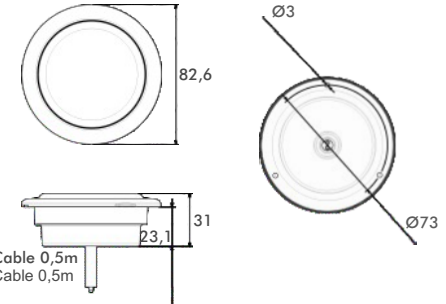

Referencia: Reference-No.	Ud. QTY	Izq. left	Dch. right	Luz Matrícula Numberplate- lamp	Descripción - Referencia O.E. Specification - O.E.-No.	Conector - Accesorios - Recambios Connector - Accessories - Spare Parts
P40.054.532	1	■	■		Luz de Posición con Tecnología Guía de LED , Cable de 0,5m Embellecedor de acero inox. LED Tail Lamp in Light guide technology , version cable 0,5m, stainless steel ring	
P40.054.501	1	■	■		Intermitente LED LED Dir. Indicator Lamp	+ info. página 2.11.0  see page 2.11.0
P40.054.522	1	■	■		Antiniebla LED LED Fog Lamp	+ info. página 2.5.0  see page 2.5.0
P40.054.503	1	■	■		Marcha Atrás LED LED Reversing Lamp	+ info. página 2.5.0  see page 2.5.0
P50.140.012 12V	1	■	■		Controlador LED, intermitente - posición- freno - antiniebla- marcha atrás, 2pilotos	+ info. página 9.0.0 PRO-LCG 
P50.140.024 24V	1				LED Control Gear monitors the direction indicator lamp and is checking the stop-tail-fog-reversing lamp	see page 9.0.0
P50.141.012 12V	1	■	■		Controlador LED especial Intermitente	+ info. página 9.0.0 PRO-CONTROL 
P50.141.024 24V	1				LED Control Gear Direction Indicator function	see page 9.0.0
P50.139.012 12V	1	■	■		Controlador LED funciones 21W	+ info. página 9.3.0 PRO-LOAD 
P50.139.024 24V	1				LED Control Gear monitors the 21W functions	see page 9.3.0 
P50.125.524 24V	1	■	■		Controlador LED Para las funciones de posición. LED Control Gear Tail Light function	+ info. página 9.3.0  see page 9.3.0

Piloto trasero LED

LED Rear Combination Lamp

Tipo: PRO-WAY 12/24V

Función: Posición LED - Freno LED - Intermitente LED



Function: LED Tail Lamp - LED Stop Lamp - LED Dir. Indicator Lamp

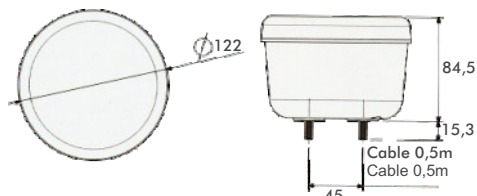

Referencia: Reference-No.	Ud. QTY	Izq. left	Dch. right	Luz Matrícula Numberplate- lamp	Descripción - Referencia O.E. Specification - O.E.-No.	Conector - Accesorios - Recambios Connector - Accessories - Spare Parts
P40.278.012	1	■	■		Versión con Cable 0,5m version cable 0,5m	
P40.278.002	1	■	■		Combinación Antiniebla/ Marcha Atrás LED combined LED Fog-/ Reversing Lamp	+ info. página 2.2.0 see page 2.2.0
P50.140.012 12V	1	■	■		Controlador LED, intermitente - posición- freno - antiniebla- marcha atrás, 2pilotos	+ info. página 9.0.0 PRO-LCG
50 140 024 24V	1				LED Control Gear monitors the direction indicator lamp and is checking the stop-tail-fog- reversing lamp	see page 9.0.0
P50.141.012 12V	1	■	■		Controlador LED especial Intermitente	+ info. página 9.0.0 PRO-CONTROL
P50.141.024 24V	1				LED Control Gear Direction Indicator function	see page 9.0.0
P50.139.012 12V	1	■	■		Controlador LED funciones 21W	+ info. página 9.3.0 PRO-LOAD
P50.139.024 24V	1				LED Control Gear monitors the 21W functions	see page 9.3.0
P50.125.524 24V	1	■	■		Cotrolador LED Para las funciones de posición. LED Control Gear Tail Light function	+ info. página 9.3.0 see page 9.3.0

Piloto trasero LED

LED Rear Combination Lamp

Tipo: PRO-TOP 12/24V IP6K9K

Función: Posición LED - Freno LED - Intermitente LED

Function: LED Tail Lamp - LED Stop Lamp - LED Dir. Indicator Lamp

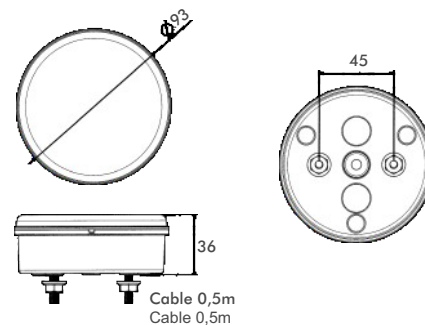

Referencia: Reference-No.	Ud. QTY	Izq. left	Dch. right	Luz Matrícula Numberplate- lamp	Descripción - Referencia O.E. Specification - O.E.-No.	Conector - Accesorios - Recambios Connector - Accessories - Spare Parts
P40.283.001	1	■	■		Versión con Cable 0,5m version cable 0,5m	
P40.283.002	1	■	■		Combinación Antiniebla/ Marcha Atrás LED combined LED Fog-/ Reversing Lamp	+ info. página 2.2.0 see page 2.2.0 
P50.140.012 12V	1	■	■		Controlador LED, intermitente - posición- freno - antiniebla- marcha atrás, 2pilotos	+ info. página 9.0.0 see page 9.0.0 PRO-LCG 
P50.140.024 24V	1				LED Control Gear monitors the direction indicator lamp and is checking the stop-tail-fog- reversing lamp	
P50.141.012 12V	1	■	■		Controlador LED especial Intermitente	+ info. página 9.0.0 see page 9.0.0 PRO-CONTROL 
P50.141.024 24V	1				LED Control Gear Direction Indicator function	
P50.139.012 12V	1	■	■		Controlador LED funciones 21W	+ info. página 9.3.0 see page 9.3.0 PRO-LOAD 
P50.139.024 24V	1				LED Control Gear monitors the 21W functions	
P50.125.524 24V	1	■	■		Cotrolador LED Para las funciones de posición. LED Control Gear Tail Light function	+ info. página 9.3.0 see page 9.3.0 

Piloto trasero LED

LED Rear Combination Lamp

Tipo: PRO-OVAL 12/24V IP6K9K

Función: Posición LED - Freno LED - Intermitente LED



Function: LED Tail Lamp - LED Stop Lamp - LED Dir. Indicator Lamp

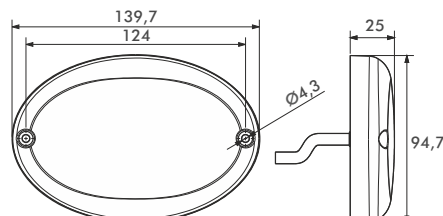

Referencia: Reference-No.	Ud. QTY	Izq. left	Dch. right	Luz Matrícula Numberplate- lamp	Descripción - Referencia O.E. Specification - O.E.-No.	Conector - Accesorios - Recambios Connector - Accessories - Spare Parts
P40.058.012	1	■	■		Luz de Posición con tecnología Guía de LED Versión con Cable 0,5m LED Tail Lamp in Light guide technology version cable 0,5m	
P40.058.002	1	■	■		Combinación Antiniebla/ Marcha Atrás LED combined LED Fog/ Reversing Lamp	+ info. página 2.4.0 see page 2.4.0
P40.058.911	1	■	■		Combinación Intermitente/ Luz de Posición LED combined LED Front Dir. Indicator-/Position Lamp	+ info. página 2.13.0 see page 2.13.0
P50.140.012 12V	1	■	■		Controlador LED, intermitente - posición- freno - antiniebla- marcha atrás, 2pilotos	+ info. página 9.0.0 PRO-LCG
P50.140.024 24V	1				LED Control Gear monitors the direction indicator lamp and is checking the stop-tail-fog- reversing lamp	see page 9.0.0
P50.141.012 12V	1	■	■		Controlador LED especial Intermitente	+ info. página 9.0.0 PRO-CONTROL
P50.141.024 24V	1				LED Control Gear Direction Indicator function	see page 9.0.0
P50.139.012 12V	1	■	■		Controlador LED funciones 21W	+ info. página 9.3.0 PRO-LOAD
P50.139.024 24V	1				LED Control Gear monitors the 21W functions	see page 9.3.0
P50.125.524 24V	1	■	■		Controlador LED Para las funciones de posición.	+ info. página 9.3.0 see page 9.3.0
					LED Control Gear Tail Light function	

Piloto trasero LED

LED Rear Combination Lamp









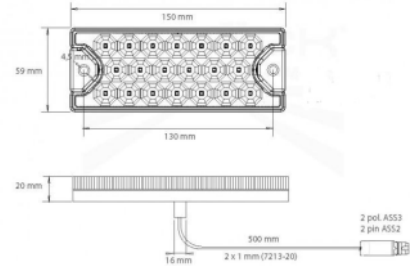

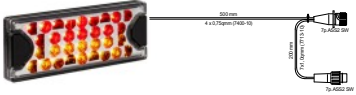
Tipo: MINI-LED II 12/24V IP6K9K

Función: Posición LED - Freno LED - Intermitente LED



Function: LED Tail Lamp - LED Stop Lamp - LED Dir. Indicator Lamp



Referencia: Reference-No.	Ud. QTY	Izq. left	Dch. right	Luz Matrícula Numberplate- lamp	Descripción - Referencia O.E. Specification - O.E.-No.	Conector - Accesorios - Recambios Connector - Accessories - Spare Parts
A33-7207-047	1	■			Cable 0,5m + conec. 7p ASS2 + cable 0.25m + conec. 3p ASS3 cable 0,5m + AMP 7p con. ASS2 + cable 0.25m + 3p con. ASS3	
A33-7207-057	1		■		Cable 0,5m + conec. 7p ASS2 + cable 0.25m + conec. 3p ASS3 cable 0,5m + AMP 7p con. ASS2 + cable 0.25m + 3p con. ASS3	
A33-7200-007	1	■	■		Versión cable 0,5m Version cable 0,5m	
A33-7200-017	1	■	■		Versión cable 5m Version cable 5m	
A32-7200-007	1	■	■		Combinación Antiniebla LED/ Marcha Atrás LED, versión cable 0.5m combined LED Fog / Reversing Lamp, version with 0.5m	
A32-7207-007	1	■	■		Combinación Antiniebla LED/ Marcha Atrás LED, con conector ASS3 3p. y cable 0.5m combined LED Fog / Reversing Lamp, version with 0.5m and	
A38-7200-007	1	■	■		Versión Marcha atrás LED con Cable 0,5m version LED Reversing Lamp cable 0,5m	
A38-7207-007	1	■	■		Versión Marcha atrás LED con Cable 0,5m y conector ASS3 2p. version LED Reversing Lamp cable 0,5m and ASS3 2p.	
A37-7200-007	1	■	■		Versión Antiniebla LED con Cable 0,5m version LED Reversing Lamp cable 0,5m	
A37-7207-007	1	■	■		Versión Antiniebla LED con Cable 0,5m y conector ASS3 2p. version LED Reversing Lamp cable 0,5m and ASS3 2p.	

Piloto trasero LED

LED Rear Combination Lamp

Tipo: BRASPOINT 140 12/24V IP6K9K

Función: Posición LED - Marcha Atrás LED - Antiniebla LED
Reflector rojo

Function: LED Tail Lamp - LED reversing lamp - LED Fog Light
Lamp reflector

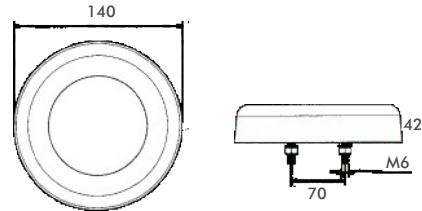

Referencia: Reference-No.	Ud. QTY	Izq. left	Dch. right	Luz Matrícula Numberplate- lamp	Descripción - Referencia O.E. Specification - O.E.-No.	Conector - Accesorios - Recambios Connector - Accessories - Spare Parts
A33-8100-207	1	■	■		Versión con Cable 0,5m version cable 0,5m	
A33-8100-707	1	■	■		Versión con cable 0.5m y bayoneta 8pin Version cable 0.5m + 8 pin bajonet	
A33-8107-037	1	■	■		Versión con cable 0.5m y conector 7pin ASS2 Version cable 0.5m + 7 pin connector ASS2	
P50.140.012 12V	1	■	■		Controlador LED, intermitente - posición- freno - antiniebla- marcha atrás, 2pilotos LED Control Gear monitors the direction indicator lamp and is checking the stop-tail-fog- reversing lamp	+ info. página 9.0.0 PRO-LCG see page 9.0.0
P50.140.024 24V	1					
P50.141.012 12V	1	■	■		Controlador LED especial Intermitente	+ info. página 9.0.0 PRO-CONTROL see page 9.0.0
P50.141.024 24V	1				LED Control Gear Direction Indicator function	
P50.139.012 12V	1	■	■		Controlador LED funciones 21W	+ info. página 9.3.0 PRO-LOAD see page 9.3.0
P50.139.024 24V	1				LED Control Gear monitors the 21W functions	

Piloto trasero LED

LED Rear Combination Lamp

Tipo: BRASPOINT 140 12/24V IP6K9K

Función: Posición LED - Freno LED - Intermitente LED

Function: LED Tail Lamp - LED Stop Lamp - LED Dir. Indicator Lamp

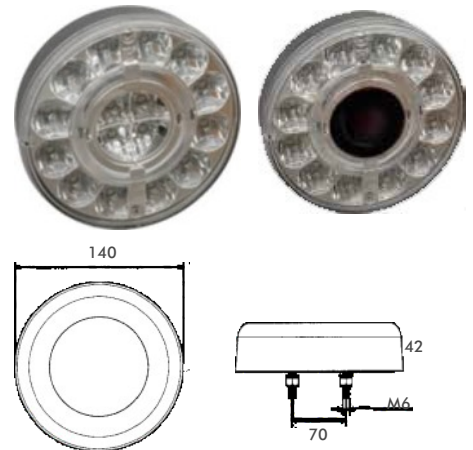

Referencia: Reference-No.	Ud. QTY	Izq. left	Dch. right	Luz Matrícula Numberplate- lamp	Descripción - Referencia O.E. Specification - O.E.-No.	Conector - Accesorios - Recambios Connector - Accessories - Spare Parts
A33-9200-207	1	■	■		Versión con Cable 0,5m version cable 0,5m	
A33-9200-707	1	■	■		Versión con cable 0.5m + bayoneta 5p Version cable 0.5m + 5p bayonet	
A33-9200-717	1	■	■		Versión con cable 0.5 + bayoneta 8p macho + cable 0.25m + bayoneta 8p hembra version cable 0.5m + bajonet 8p male + cable 0.25m + bayonet 8p female	
A33-9207-067	1	■	■		Versión con cable 0.5 + conector 7p macho ASS2 + cable 0.25m + conector 7p hembra ASS2 version cable 0.5m + connector 7p male ASS2 + cable 0.25m + connector 7p female ASS2	
A33-9207-097	1	■	■		Versión con cable 0.5 + conector 7p macho AMP + cable 0.25m + conector 7p hembra ASS2 Version cable 0.5m + connector 7p male AMP + cable 0.25m + connector 7p female ASS2	
A33-9200-307	1	■	■		Versión cable 0.5m posición y freno LED Version cable 0.5m LED tail lamp + stop lamp	 Posición y freno LED
A33-9207-077	1	■	■		Versión con cable 0.5 + conector 7p macho ASS2 + cable 0.25m + conector 7p hembra ASS2 version cable 0.5m + connector 7p male ASS2 + cable 0.25m + connector 7p female ASS2	 Posición y freno LED

Piloto trasero LED

LED Rear Combination Lamp

Tipo: BRASPOINT 98 12/24V IP6K9K

Función: Posición LED - Marcha Atrás LED - Antiniebla LED
Reflectante rojo

Function: LED Tail Lamp - LED reversing lamp - LED Fog Light
Lamp reflector

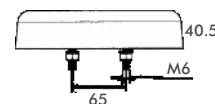
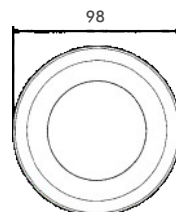

Referencia: Reference-No.	Ud. QTY	Izq. left	Dch. right	Luz Matrícula Numberplate- lamp	Descripción - Referencia O.E. Specification - O.E.-No.	Conector - Accesorios - Recambios Connector - Accessories - Spare Parts
A33-8100-007	1	■	■		Versión con Cable 0,5m fijación vertical version cable 0,5m vertical fixation	
A33-8100-107	1	■	■		Versión con Cable 0,5m fijación horizontal version cable 0,5m horizontal fixation	
A33-8100-507	1	■	■		Versión con Cable 0,5m + bayoneta 8p., fijación vertical version cable 0,5m + 8p bayonet, vertical fixation	
A33-8100-607	1	■	■		Versión con Cable 0,5m + bayoneta 8p., fijación horizontal version cable 0,5m + 8p bayonet, horizontal fixation	
A33-8107-047	1	■	■		Versión con Cable 0,5m + conector 7p. ASS2, fijación vertical version cable 0,5m + 7p ASS2 connector, vertical fixation	
A33-8107-057	1	■	■		Versión con Cable 0,5m + conector 7p. ASS2, fijación horizontal version cable 0,5m + 7p ASS2 connector, horizontal fixation	
A33-8180-007	1	■	■		Versión con Cable 0,5m + conector hembra 4p. AMP, fijación vertical version cable 0,5m + 7p female AMP connector, vertical fixation	

Piloto trasero LED

LED Rear Combination Lamp

Tipo: BRASPOINT 98 12/24V IP6K9K

Función: Posición LED - Freno LED - Intermitente LED



Function: LED Tail Lamp - LED Stop Lamp - LED Dir. Indicator Lamp

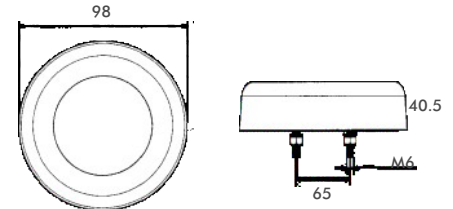

Referencia: Reference-No.	Ud. QTY	Izq. left	Dch. right	Luz Matrícula Numberplate- lamp	Descripción - Referencia O.E. Specification - O.E.-No.	Conector - Accesorios - Recambios Connector - Accessories - Spare Parts
A33-9200-007	1	■	■		Versión con Cable 0,5m version cable 0,5m	
A33-9200-017	1	■	■		Versión con cable 7m Version cable 7m	
A33-9200-027	1	■	■		Versión con cable 2m version cable 2m	
A33-9200-507	1	■	■		Versión con cable 0.5 + bayoneta 5p macho version cable 0.5m + 5p bayonet	
A33-9200-517	1	■	■		Versión con cable 0.5 + bayoneta 8p macho + cable 0.25m + bayoneta 8p hembra version cable 0.5m + bajonet 8p male + cable 0.25m + bayonet 8p female	
A33-9207-057	1	■	■		Versión con cable 0.5 + con. 7p macho ASS2 + cable 0.25m + conector 7p hembra ASS2 version cable 0.5m + connector 7p male ASS2 + cable 0.25m + connector 7p female ASS2	
A33-9207-087	1	■	■		Versión con cable 0.5 + con. 7p macho AMP + cable 0.25m + con. 7p hembra ASS2 Version cable 0.5m + connector 7p male AMP + cable 0.25m + connector 7p female ASS2	
A33-9280-007	1	■	■		Versión con cable 0.5 + conector 4p hembra AMP version cable 0.5m + female 4p AMP connector	

Piloto trasero LED







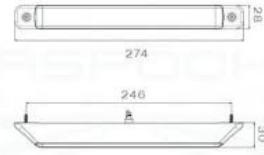

LED Rear Combination Lamp

Tipo: LINEPOINT II 12/24V IP6K9K

Función: Intermitente progresivo LED -
Intermitente LED

Function: LED Progressive Dir. Indicator Lamp -
LED Direction indicator



Referencia: Reference-No.	Ud. QTY	Izq. left	Dch. right	Luz Matrícula Numberplate- lamp	Descripción - Referencia O.E. Specification - O.E.-No.	Conector - Accesorios - Recambios Connector - Accessories - Spare Parts
A31-9207-031	1	■			Intermitente progresivo LED Versión con Cable 0,5m + conector hembra 2p ASS3 LED Progres. direct. indic.,cable 0,5m + 2p female connec. ASS3	 Montaje Horizontal
A31-9207-071	1	■			Intermitente progresivo LED Versión con Cable 0,25m + conector hembra 2p ASS3 LED Progres. direct. indic.,cable 0,25m + 2p fem. connec. ASS3	 Montaje Horizontal
A31-9231-201	1	■			Intermitente progresivo LED Versión con Cable 0,5m LED Progres. direct. indic.,cable 0,5m	 Montaje Horizontal
A31-9207-021	1		■		Intermitente progresivo LED Versión con Cable 0,5m + conector hembra 2p ASS3 LED Progres. direct. indic.,cable 0,5m + 2p female connec. ASS3	 Montaje Horizontal
A31-9207-061	1		■		Intermitente progresivo LED Versión con Cable 0,25m + conector hembra 2p ASS3 LED Progres. direct. indic.,cable 0,25m + 2p fem. connec. ASS3	 Montaje Horizontal
A31-9231-211	1		■		Intermitente progresivo LED Versión con Cable 0,5m LED Progres. direct. indic.,cable 0,5m	 Montaje Horizontal
A31-9207-011	1	■	■		Intermitente LED Versión con Cable 0,5m + conector hembra 3p ASS3 LED Direction indicator,cable 0,5m + 2p female connec. ASS3	 Montaje 360°
A31-9231-001	1	■	■		Intermitente LED Versión con Cable 0,5m LED Direction indicator, cable 0,5m	 Montaje 360°

Piloto trasero LED











LED Rear Combination Lamp

Tipo: LINEPOINT II 12/24V IP6K9K

Función: Posición LED - Freno LED - Antiniebla LED
 Marcha Atrás LED

Function: LED Tail Lamp - LED Stop Lamp -
 LED Reversing Lamp - LED Fog Lamp



Referencia: Reference-No.	Ud. QTY	Izq. left	Dch. right	Luz Matrícula Numberplate- lamp	Descripción - Referencia O.E. Specification - O.E.-No.	Conector - Accesorios - Recambios Connector - Accessories - Spare Parts
A31-9207-001	1	■	■		Versión con Cable 0,5m + conector hembra 3p ASS3 Version cable 0,5m + 3p female connec. ASS3	 Posición + Freno Montaje 360°
A31-9230-001	1	■	■		Versión con Cable 0,5m Version cable 0,5m	 Posición + Freno Montaje 360°
A31-9207-081	1	■	■		Versión con Cable 0,25m + conector hembra 3p ASS3 Version cable 0,25m + 3p female connec. ASS3	 Posición + Freno Montaje 360°
A37-9207-001	1	■	■		Versión con Cable 0,5m + conector hembra 3p ASS3 Version cable 0,5m + 3p female connec. ASS3	 Antiniebla Montaje 360°
A37-9230-001	1	■	■		Versión con Cable 0,5m Version cable 0,5m	 Antiniebla Montaje 360°
A38-9207-001	1	■	■		Versión con Cable 0,5m + conector hembra 3p ASS3 Version cable 0,5m + 3p female connec. ASS3	 Marcha Atrás Montaje horizontal
A38-9230-001	1	■	■		Versión con Cable 0,5m Version cable 0,5m	 Marcha Atrás Montaje vertical
A38-9231-001	1	■	■		Versión con Cable 0,5m Version cable 0,5m	 Marcha Atrás Montaje horizontal
A38-9237-001	1	■	■		Versión con Cable 0,5m + conector hembra 3p ASS3 Version cable 0,5m + 3p female connec. ASS3	 Marcha Atrás Montaje vertical
A38-9207-021	1	■	■		Versión con Cable 0,25m + conector hembra 3p ASS3 Version cable 0,25m + 3p female connec. ASS3	 Marcha Atrás Montaje horizontal

Piloto trasero LED



LED Rear Combination Lamp

Tipo: FT-130 12/36V

Función: Luz posición LED - Luz de freno LED -
 Luz intermitente LED - Luz marcha atrás LED -
 Luz antiniebla LED - Luz matrícula - Reflectante

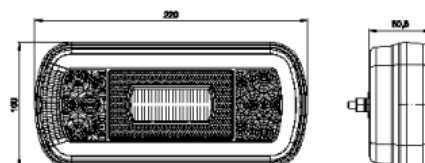
Function: LED Tail Lamp - LED Stop Lamp - LED Dir. Indicator
 Lamp - LED Reversing Lamp - LED Fog Lamp -
 LED Numberplate Lamp - Reflex Reflector



Referencia: Reference-No.	Ud. QTY	Izq. left	Dch. right	Luz Matrícula Numberplate- lamp	Descripción - Referencia O.E. Specification - O.E.-No.	Conector - Accesorios - Recambios Connector - Accessories - Spare Parts
FT-130BAJPM/I	1	■		■	Versión con Conector 5p version 5p. connector	
FT-130BACOF/D	1		■	■	Versión con Conector 5p version 5p. connector	
FT-130CABPM/I	1	■		■	Versión con Cable 1m.	
FT-130CABCOF/D	1		■	■	Versión con Cable 1m.	
A13-0546-004	1	■	■		Kit conector Repairkit	

Piloto trasero LED

LED Rear Combination Lamp

Tipo: PRO-DISC 12/24V IP6K9K

Función: 2 x Luz Posición LED - 2 x Luz Freno LED - Intermitente LED

Function: 2 x LED Tail Lamp - 2 x LED Stop Lamp - LED Dir. Indicator Lamp

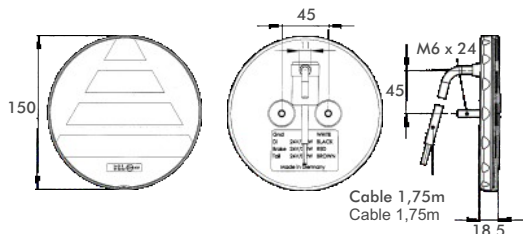
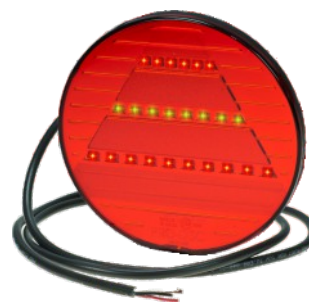

Referencia: Reference-No.	Ud. QTY	Izq. left	Dch. right	Luz Matrícula Numberplate- lamp	Descripción - Referencia O.E. Specification - O.E.-No.	Conector - Accesorios - Recambios Connector - Accessories - Spare Parts
P40.050.501	1	■	■		Versión con Cable 1,8m version cable 1,8m	
P40.053.002	1	■	■		Combinación Antiniebla-/ Marcha Atrás LED combined LED Fog-/ Reversing Lamp	+ info. página 2.2.0 see page 2.2.0
P50.140.012 12V	1	■	■		Controlador LED, intermitente - posición- freno - antiniebla- marcha atrás, 2pilotos	+ info. página 9.0.0 PRO-LCG see page 9.0.0
P50.140.024 24V	1				LED Control Gear monitors the direction indicator lamp and is checking the stop-tail-fog- reversing lamp	
P50.141.012 12V	1	■	■		Controlador LED especial Intermitente	+ info. página 9.0.0 PRO-CONTROL see page 9.0.0
P50.141.024 24V	1				LED Control Gear Direction Indicator function	
P50.139.012 12V	1	■	■		Controlador LED funciones 21W	+ info. página 9.3.0 PRO-LOAD see page 9.3.0
P50.139.024 24V	1				LED Control Gear monitors the 21W functions	
P50.125.524 24V	1	■	■		Cotrolador LED Para las funciones de posición. LED Control Gear Tail Light function	+ info. página 9.3.0 see page 9.3.0

NEW

ASPÖCK
IBERICA

PROPLAST

FAHRZEUGBELEUCHTUNG

www.aspock.com

Catálogo 2022/2023

Página 1.37.1

Piloto trasero LED





LED Rear Combination Lamp

Tipo: PRO-SUPER-DISC 12/24V

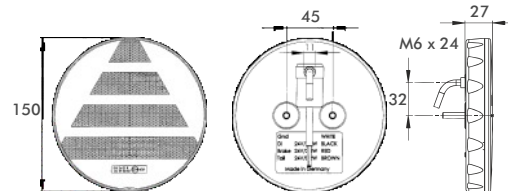
Función: 2 x Posición LED - 2 x Freno LED -
Intermitente LED - Triángulo reflectante
12/24V Unidad de control intermitente (PRO-CONTROL)

Function: 2 x LED Tail Lamp - 2 x LED Stop Lamp -
LED Dir. Indicator Lamp - Triangle Reflex Reflector
12/24V Flasher control unit (PRO-CONTROL)



Referencia: Reference-No.	Ud. QTY	Izq. left	Dch. right	Luz Matrícula Numberplate- lamp	Descripción - Referencia O.E. Specification - O.E.-No.	Conector - Accesorios - Recambios Connector - Accessories - Spare Parts
P40.050.601 	1	■	■		<p>Unidad de control integrada LED -PRO-CONTROL (Control intermitente)</p> <p>Carcasa: ABS Tulipa: PMMA Conexión: 1,8m puntas abiertas Voltaje: 12/24 Volt Protección: IP6K9K Homolog.: ECE ADR EMV</p> <p>Intermitente: 12V-18W / 24V-22W Posición: 12V-0,5W / 24V-1,2W Freno: 12V-4W / 24V-4,6W</p> <p><i>PRO-CONTROL integrated LED Control Gear for Dir. Indicator</i></p> <p>Housing: ABS Lens: PMMA Cable: 1,8m open end Voltage: 12/24 Volt Protection: IP6K9K Homologation: ECE approved ADR approved EMC approved</p> <p>Dir. Indicator: 12V-18,0W / 24V-22,0W Tail: 12V-0,5W / 24V-1,2W Stop: 12V-4,0W / 24V-4,6W</p>	 
P40.053.002	1	■	■		<p>Antiniebla / Marcha Atrás LED</p> <p>Carcasa: ABS Tulipa: PMMA Conexión: 1,8m puntas abiertas Voltaje: 12/24 Volt Protección: IP6K9K Homolog.: ECE geprüft ADR geprüft EMV geprüft</p> <p>Antiniebla: 12V-4,0W / 24V-4,0W M. Atrás: 12V-4,0W / 24V-4,0W</p> <p><i>Combined LED Fog-/Reversing Lamp</i></p> <p>Housing: ABS Lens: PMMA Cable: 1,8m open end Voltage: 12/24 Volt Protection: IP6K9K Homologation: ECE approved ADR approved EMC approved</p> <p>Fog: 12V-4,0W / 24V-4,0W Reverse: 12V-4,0W / 24V-4,0W</p>	

Piloto trasero LED

LED Rear Combination Lamp

Tipo: PRO-DISC 12/24V IP6K9K

Función: 2 x Luz Posición LED - 2 x Luz Freno LED -
Intermitente LED - Triángulo Reflectante

Function: 2 x LED Tail Lamp - 2 x LED Stop Lamp -
LED Dir. Indicator Lamp - Triangle Reflex Reflector

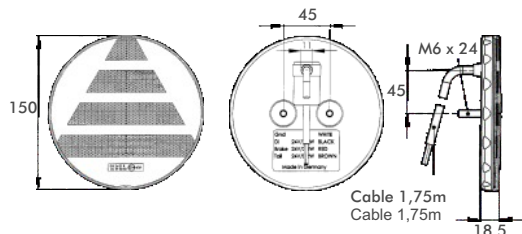

Referencia: Reference-No.	Ud. QTY	Izq. left	Dch. right	Luz Matrícula Numberplate- lamp	Descripción - Referencia O.E. Specification - O.E.-No.	Conector - Accesorios - Recambios Connector - Accessories - Spare Parts
P40.050.001	1	■	■		Versión con Cable 1,8m version cable 1,8m	
P40.050.212	1	■	■		Versión con Cable 0,2m + Conector 5-p. Version with cable 0,2m + connector 5-poles	
P40.050.301	1	■	■		Versión con Cable 0,3m version cable 0,3m	
P40.053.002	1	■	■		Combinación Antiniebla/ Marcha Atrás LED combined LED Fog-/ Reversing Lamp	+ info. página 2.2.0 see page 2.2.0
P50.140.012 12V	1	■	■		Controlador LED, intermitente - posición- freno - antiniebla- marcha atrás, 2pilotos	+ info. página 9.0.0 PRO-LCG
P50.140.024 24V	1				LED Control Gear monitors the direction indicator lamp and is checking the stop-tail-fog- reversing lamp	see page 9.0.0
P50.141.012 12V	1	■	■		Controlador LED especial Intermitente	+ info. página 9.0.0 PRO-CONTROL
P50.141.024 24V	1				LED Control Gear Direction Indicator function	see page 9.0.0
P50.139.012 12V	1	■	■		Controlador LED funciones 21W	+ info. página 9.3.0 PRO-LOAD
P50.139.024 24V	1				LED Control Gear monitors the 21W functions	see page 9.3.0

NEW

ASPÖCK
IBERICA

PROPLAST

FAHRZEUGBELEUCHTUNG

www.aspock.com

Catálogo 2022/2023

Piloto trasero LED

LED Rear Combination Lamp

Tipo: PRO-MULTI-DISC 12/24V

Función: 2 x Posición LED - 2 x Freno LED -
Intermitente LED - Triángulo reflectante
12/24V Unidad de control intermitente (PRO-CONTROL)
integr. PRO-BLINK (Módulo-Interm. para SML)

Function: 2 x LED Tail Lamp - 2 x LED Stop Lamp -
LED Dir. Indicator Lamp - Triangle Reflex Reflector
12/24V Flasher control unit (PRO-CONTROL)
integr. PRO-BLINK (Blink-Unit for Sidemarker lamps)

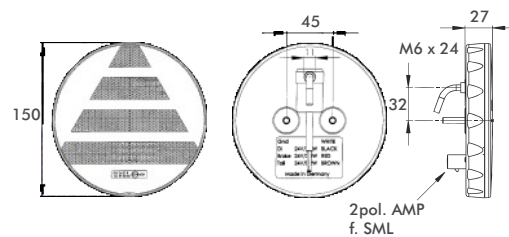
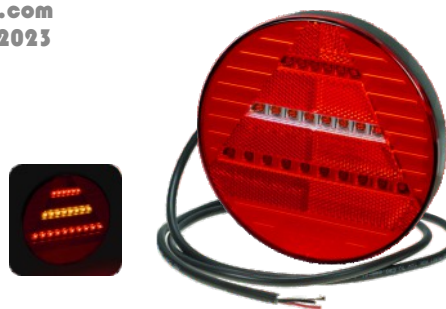

Referencia: Reference-No.	Ud. QTY	Izq. left	Dch. right	Luz Matrícula Numberplate- lamp	Descripción - Referencia O.E. Specification - O.E.-No.	Conector - Accesorios - Recambios Connector - Accessories - Spare Parts
P40.050.701 	1	■	■		<p>Conector 2-pol. AMP salida módulo intermitente para activar las luces laterales max. 1A Carcasa: ABS Tulipa: PMMA Conexión: 1,8m offenes Ende voltaje: 12/24 Volt Protección: IP6K9K Homolog.: ECE geprüft ADR geprüft EMV geprüft</p> <p>Intermitente: 12V-18W / 24V-22W Posición: 12V-0,5W / 24V-1,2W Freno: 12V-4W / 24V-4,6W</p> <p>2-poles AMP output Blink-Unit for triggering the sidemarker lamps max. 1A Housing: ABS Lens: PMMA Cable: 1,8m open end Voltage: 12/24 Volt Protection: IP6K9K Homologation: ECE approved ADR approved EMC approved</p> <p>Dir. Indicator: 12V-18,0W / 24V-22,0W Tail: 12V-0,5W / 24V-1,2W Stop: 12V-4,0W / 24V-4,6W</p>	

Posibilidad de instalación con luces laterales LED
Fitting possibilities with LED Sidemarker Lamps

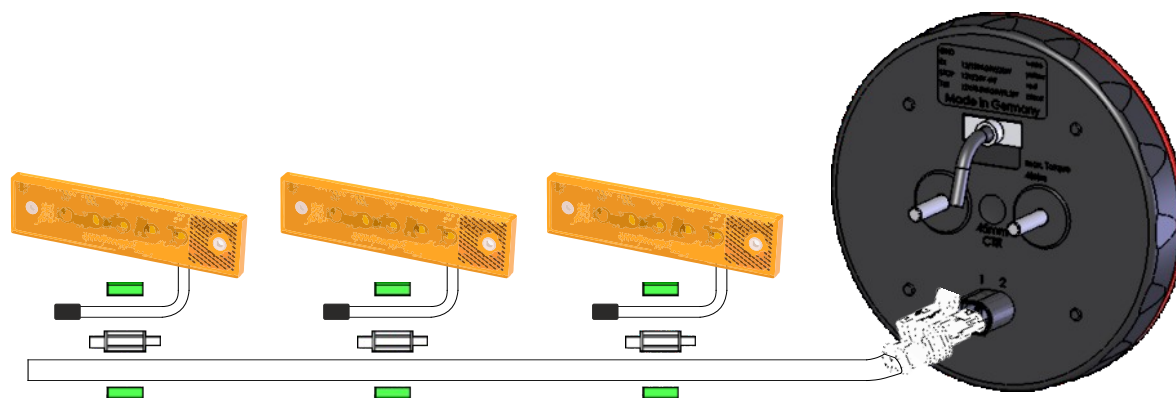

Piloto trasero LED

LED Rear Combination Lamp

Tipo: PRO-DISC 12/24V IP6K9K

Función: 2 x Luz Posición LED - 2 x Luz Freno LED -
Intermitente LED - Triángulo Reflectante

Function: 2 x LED Tail Lamp - 2 x LED Stop Lamp -
LED Dir. Indicator Lamp - Triangle Reflex Reflector

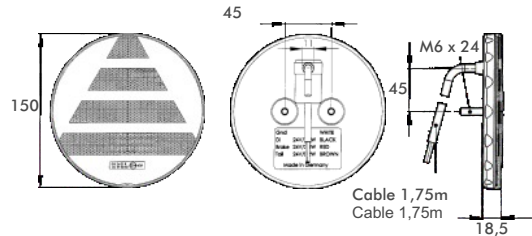
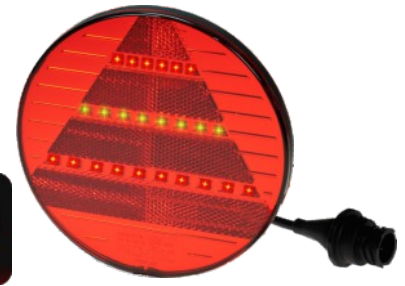

Referencia: Reference-No.	Ud. QTY	Izq. left	Dch. right	Luz Matrícula Numberplate- lamp	Descripción - Referencia O.E. Specification - O.E.-No.	Conector - Accesorios - Recambios Connector - Accessories - Spare Parts
P40.050.201	1	■	■		Versión con Cable 0,5m + Conector AMP 7-p. version cable 0,5m + 7-pol. AMP connector	
P40.053.202	1	■	■		Combinación Antiniebla/ Marcha Atrás LED + conector AMP 7p. combined LED Fog-/ Reversing Lamp, cable 0,5m + 7-pol. AMP connector	+ info. página 2.2.0 see page 2.2
P50.140.412 12V	1	■	■		Controlador LED pre-montado supervisa el intermitente y comprueba las luces de posición-freno-niebla-luz de marcha atrás LED. Conectores incluidos.	+ info. página 9.1.0 PRO-LCG
P50.140.424 24V	1				LED Control Gear monitors the direction indicator lamp and is checking the stop-tail-fog- reversing lamp	see page 9.1

Posibilidades de ajuste con la centralita de control LED:
Plug & Play PRO-DISC & PRO-DISC FR

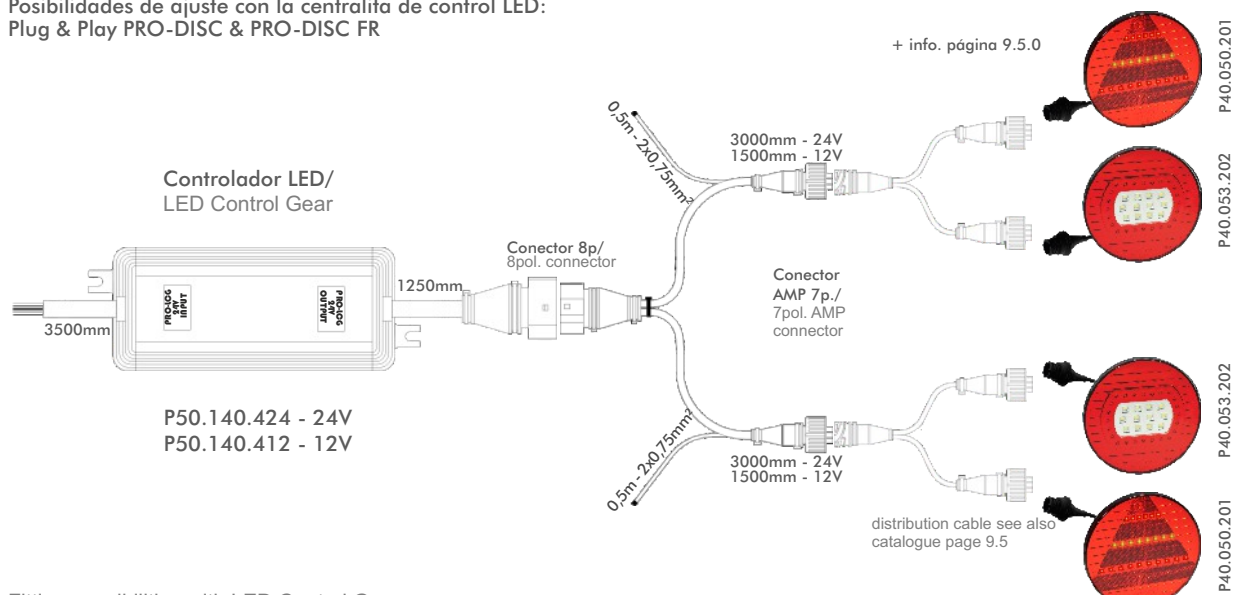

Fitting possibilities with LED Control Gear:
Plug 'n Play PRO-DISC & PRO-DISC FR

Piloto trasero LED

LED Rear Combination Lamp

Tipo: PRO-CARGO II "Trailer" 12/24V

Función: Posición LED - Freno LED -
intermitente secuencial LED -
Marcha Atrás LED - Antiniebla LED - Triángulo
Reflectante

Function: LED Tail Lamp - LED Stop Lamp -
sequential LED Dir. Indicator Lamp -
LED Reversing Lamp - LED Fog Lamp -
Triangle Reflex Reflector

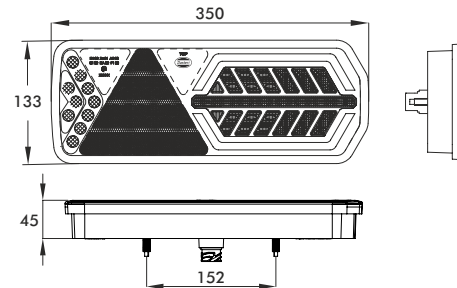

Referencia: Reference-No.	Ud. QTY	Izq. left	Dch. right	Luz Matrícula Numberplate- lamp	Descripción - Referencia O.E. Specification - O.E.-No.	Conector - Accesorios - Recambios Connector - Accessories - Spare Parts
P40.708.011	1	■			<p>Luz de Posición Guía de Led Carcasa: ABS+PC Tulipa: PMMA+PC Conexión: 2,0m puntas abiertas Voltaje: 12/24 Volt Protección: IP6K9K Homolog.: ECE EMV Intermitente: 12V-3,5W / 24V-3,5W Posición: 12V-3,2W / 24V-3,2W Freno: 12V-2,0W / 24V-2,0W Niebla: 12V-4,0W / 24V-4,0W M. atrás: 12V-2,5W / 24V-2,5W</p>	
P40.708.012	1		■		<p>LED Tail Lamp in Light guide technology Housing: ABS+PC Lens: PMMA+PC Cable: 2,0m open end Voltage: 12/24 Volt Protection: IP6K9K Homologation: ECE approved EMC approved Dir. Indicator: 12V-3,5W / 24V-3,5W Tail: 12V-3,2W / 24V-3,2W Stop: 12V-2,0W / 24V-2,0W Fog: 12V-4,0W / 24V-4,0W Reverse: 12V-2,5W / 24V-2,5W</p>	
P40.708.211	1	■			<p>Luz de Posición Guía de Led Carcasa: ABS+PC Tulipa: PMMA+PC Conexión: Conector 7p. AMP Voltaje: 12/24 Volt Protección: IP6K9K Homolog.: ECE EMV Intermitente: 12V-3,5W / 24V-3,5W Posición: 12V-3,2W / 24V-3,2W Freno: 12V-2,0W / 24V-2,0W Niebla: 12V-4,0W / 24V-4,0W M. atrás: 12V-2,5W / 24V-2,5W</p>	
P40.708.212	1		■		<p>LED Tail Lamp in Light guide technology Housing: ABS+PC Lens: PMMA+PC Cable: 7-pin AMP connector Voltage: 12/24 Volt Protection: IP6K9K Homologation: ECE approved EMC approved Dir. Indicator: 12V-3,5W / 24V-3,5W Tail: 12V-3,2W / 24V-3,2W Stop: 12V-2,0W / 24V-2,0W Fog: 12V-4,0W / 24V-4,0W Reverse: 12V-2,5W / 24V-2,5W</p>	

Piloto trasero LED

LED Rear Combination Lamp

Tipo: PRO-5/5F 24V IP67

Función: Luz Pasición LED x 2 - Freno LED - Intermitente secuencial LED - Marcha Atrás LED - Antiniebla LED - Triángulo Reflectante - Módulos LED y Reflectante reemplazables individualmente

Function: 2x LED Tail Lamp - LED Stop Lamp - sequential LED Dir. Indicator Lamp - LED Reversing

Lamp -

LED Fog Lamp - Triangle Reflex Reflector

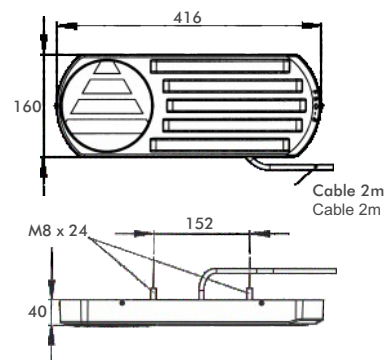

Referencia: Reference-No.	Ud. QTY	Izq. left	Dch. right	Luz Matrícula Numberplate- lamp	Descripción - Referencia O.E. Specification - O.E.-No.	Conector - Accesorios - Recambios Connector - Accessories - Spare Parts
P40.280.011	1	■			Versión con Cable 2m version with cable 2,0m	
P40.280.012	1		■		Versión con Cable 2m version with cable 2,0m	
P40.280.411	1	■			Versión con Cable 1m + conector ASS2, Intermitente Secuencial NEW	
P40.280.412			■		Versión con Cable 1m + conector ASS2, Intermitente Secuencial NEW	
P40.026.032 24V	1	■	■		Módulo LED Freno-Posición LED Unit Stop-Tail Lamp	PRO-CAN XL
P40.026.051 24V	1	■	■		Módulo LED Intermitente Secuencial LED Unit sequential Dir. Indicator Lamp	PRO-CAN XL
P40.026.002 24V	1	■	■		Módulo LED Luz Posición LED Unit Tail Lamp	PRO-CAN XL
P40.026.503 24V	1	■	■		Módulo LED Marcha Atrás LED Unit Reversing Lamp	PRO-CAN XL
P40.026.022 24V	1	■	■		Módulo LED Antiniebla LED Unit Fog Lamp	PRO-CAN XL
P20.105.004	1	■	■		Triángulo Reflectante de vidrio óptico brillante transparente Reflex Reflector in brilliant clear glass optic	PRO-REFLEX
P40.280.112	1	■	■		Cubierta para base piloto color antracita Cover for housing in anthracite	

Piloto trasero LED

LED Rear Combination Lamp

Tipo: PRO-5/5F 24V IP67

Función: Luz Pasición LED x 2 - Freno LED - Intermitente LED - Marcha Atrás LED - Antiniebla LED Triángulo Reflectante - Módulos LED y Reflectante reemplazables individualmente

Function: 2x LED Tail Lamp - LED Stop Lamp - sequential LED Dir. Indicator Lamp - LED Reversing

Lamp - LED Fog Lamp - Triangle Reflex Reflector

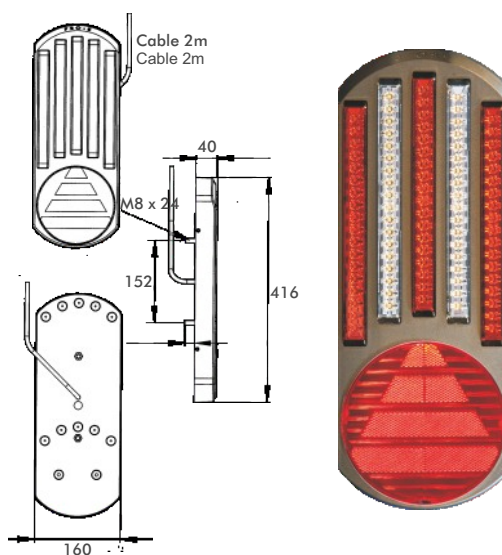

Referencia: Reference-No.	Ud. QTY	Izq. left	Dch. right	Luz Matrícula Numberplate- lamp	Descripción - Referencia O.E. Specification - O.E.-No.	Conector - Accesorios - Recambios Connector - Accessories - Spare Parts
P40.280.013	1	■			Versión con Cable 2m version with cable 2,0m	
P40.280.014	1		■		Versión con Cable 2m version with cable 2,0m	
P50.140.024 24V	1	■	■		Controlador LED, intermitente - posición- freno - antiniebla- marcha atrás, 2pilotos LED Control Gear monitors the direction indicator lamp and is checking the stop-tail-fog- reversing lamp	+ info página 9.0.0 PRO-LCG see page 9.0.0
P40.026.032 24V	1	■	■		Módulo LED Freno-Posición LED Unit Stop-Tail Lamp	PRO-CAN XL
P40.026.601 24V	1	■	■		Módulo LED Intermitente LED Unit sequential Dir. Indicator Lamp	PRO-CAN XL
P40.026.002 24V	1	■	■		Módulo LED Luz Posición LED Unit Tail Lamp	PRO-CAN XL
P40.026.503 24V	1	■	■		Módulo LED Marcha Atrás LED Unit Reversing Lamp	PRO-CAN XL
P40.026.022 24V	1	■	■		Módulo LED Antiniebla LED Unit Fog Lamp	PRO-CAN XL
P20.105.004	1	■	■		Triángulo Reflectante de vidrio óptico brillante transparente Reflex Reflector in brilliant clear glass optic	PRO-REFLEX
P40.280.112	1	■	■		Cubierta para base piloto color antracita Cover for housing in anthracite	

Piloto trasero LED

LED Rear Combination Lamp

Tipo: **PRO-MINI-CURVE 12/24V Híbrido**

Función: Luz Pasióón LED - Freno LED - Intermitente
Marcha Atrás - Antiniebla - Triángulo
Reflectante, sin bombillas

Function: LED Tail Lamp - LED Stop Lamp - Dir. Indicator Lamp -
Reversing Lamp - Fog Lamp - Triangle Reflex Reflector
without bulbs

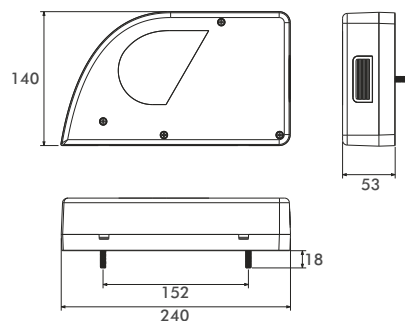

Referencia: Reference-No.	Ud. QTY	Izq. left	Dch. right	Luz Matrícula Numberplate- lamp	Descripción - Referencia O.E. Specification - O.E.-No.	Conector - Accesorios - Recambios Connector - Accessories - Spare Parts
P40.295.001	1	■		■ lateral/ lateral	Luz de Posición con Guía de LED Versión Pasa-cables LED Tail Lamp in <i>Light guide technology</i> version grommet	
P40.295.002	1		■	■ lateral/ lateral	Luz de Posición con Guía de LED Versión Pasa-cables LED Tail Lamp in <i>Light guide technology</i> version grommet	
P40.295.011	1	■		■ lateral/ lateral	Luz de Posición con Guía de LED Versión Cable 2m LED Tail Lamp in <i>Light guide technology</i> version cable 2,0m	
P40.295.012	1		■	■ lateral/ lateral	Luz de Posición con Guía de LED Versión Cable 2m LED Tail Lamp in <i>Light guide technology</i> version cable 2,0m	
P40.295.111	1	■			Tulipa Lens	
P40.295.112	1		■		Tulipa Lens	
P50.139.012 12V	1	■	■		Controlador LED funciones 21W	+ info página 9.3.0 PRO-LOAD
P50.139.024 24V	1	■	■		LED Control Gear monitors the 21W functions	 see page 9.3.0

Piloto trasero LED

LED Rear Combination Lamp

Tipo: PRO-MINI-CURVE 12/24V Híbrido

Función: Luz Pasición LED - Freno LED - Intermitente
Marcha Atrás - Antiniebla - Triángulo
Reflectante, sin bombillas

Function: LED Tail Lamp - LED Stop Lamp - Dir. Indicator Lamp -
Reversing Lamp - Fog Lamp - Triangle Reflex Reflector
with bulbs fitted

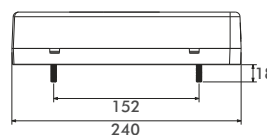
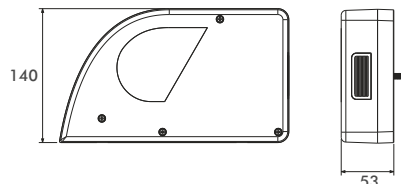

Referencia: Reference-No.	Ud. QTY	Izq. left	Dch. right	Luz Matrícula Numberplate- lamp	Anti- Niebla Fog- lamp	Marcha- Atrás Reversing lamp	Descripción - Referencia O.E. Specification - O.E.-No.	Conector. - Recambio Connector - Spare Parts
P40.295.211 24V	1	■		■ lateral/ lateral	■	■	Luz de Posición con Guía de LED Versión con Cable0.5m + conector AMP 7p. LED Tail Lamp in Light guide technology version cable 0,5m + 7-pol. AMP con.	
P40.295.212 24V	1		■	■ lateral/ lateral	■	■	Luz de Posición con Guía de LED Versión con Cable0.5m + conector AMP 7p. LED Tail Lamp in Light guide technology version cable 0,5m + 7-pol. AMP con.	
P40.295.511 12V	1	■		■ lateral/ lateral	■		Luz de Posición con Guía de LED Versión con Cable0.5m + conector AMP 5p. LED Tail Lamp in Light guide technology version cable 0,5m + connector 5-pol.	
P40.295.512 12V	1		■	■ lateral/ lateral			Luz de Posición con Guía de LED Versión con Cable0.5m + conector AMP 5p. LED Tail Lamp in Light guide technology version cable 0,5m + connector 5-pol.	
P40.295.513 12V	1		■	■ lateral/ lateral		■	Luz de Posición con Guía de LED Versión con Cable0.5m + conector AMP 5p. LED Tail Lamp in Light guide technology version cable 0,5m + connector 5-pol.	
P50.071.100	1	■	■				Kit bayoneta 7p. Repairkit 7-poles	
P50.047.000	1	■	■				Kit bayoneta 5p. Repairkit 5-poles	

Piloto trasero LED

LED Rear Combination Lamp

Tipo: PRO-CURVE 12/24V IP6K9K

Función: Luz Pasi3n LED - Freno LED - Intermitente
 LED - Marcha Atrás LED - Antiniebla LED - Triángulo
 Reflectante

Function: LED Tail Lamp - LED Stop Lamp - LED Dir. Indicator
 Lamp -
 LED Reversing Lamp - LED Fog Lamp -

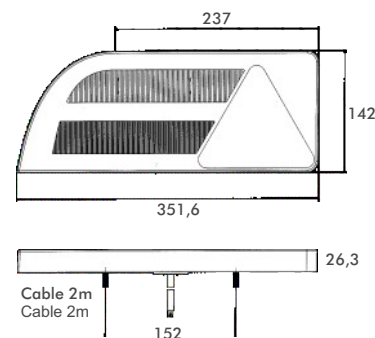

Referencia: Reference-No.	Ud. QTY	Izq. left	Dch. right	Luz Matrícula Numberplate- lamp	Descripción - Referencia O.E. Specification - O.E.-No.	Conector - Accesorios - Recambios Connector - Accessories - Spare Parts
P40.292.011	1	■			Versión con Cable 2m version with cable 2,0m	
P40.292.012	1		■		Versión con Cable 2m version with cable 2,0m	
P40.292.211	1	■			Versión con Conector AMP 7p version with AMP connector 7p	
P40.292.212	1		■		Versión con Conector AMP 7p version with AMP connector 7p	
P40.292.311	1	■			Versión con Cable 0,5m + Conector 7p. tipo ASS2 version with cable 2,0m + ASS2 connector 7-poles	
P40.292.312	1		■		Versión con Cable 0,5m + Conector 7p. tipo ASS2 version with cable 2,0m + ASS2 connector 7-poles	

Piloto trasero LED

LED Rear Combination Lamp

Tipo: PRO-CURVE 12/24V IP6K9K

Función: Luz Pación LED - Freno LED - **Intermitente Secuencial** LED - Marcha Atrás LED - Antiniebla LED - Triángulo Reflectante

Function: LED Tail Lamp - LED Stop Lamp - LED Dir. Indicator Secuencial Lamp - LED Reversing Lamp - LED Fog Lamp - Triangle Reflex Reflector

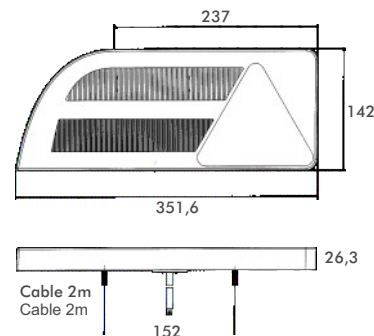

Referencia: Reference-No.	Ud. QTY	Izq. left	Dch. right	Luz Matrícula Numberplate- lamp	Descripción - Referencia O.E. Specification - O.E.-No.	Conector - Accesorios - Recambios Connector - Accessories - Spare Parts
P40.292.511	1	■			Versión con Cable 2m version with cable 2,0m	
P40.292.512	1		■		Versión con Cable 2m version with cable 2,0m	
P40.292.611	1	■			Versión con Conector AMP 7p version with AMP connector 7p	
P40.292.612	1		■		Versión con Conector AMP 7p version with AMP connector 7p	
P40.292.711	1	■			Versión con Cable 0,5m + Conector 7p. tipo ASS2 version with cable 2,0m + ASS2 connector 7-poles	
P40.292.712	1		■		Versión con Cable 0,5m + Conector 7p. tipo ASS2 version with cable 2,0m + ASS2 connector 7-poles	

Piloto trasero LED

LED Rear Combination Lamp

Tipo: ECOLED II 12/24V IP6K9K

Función: Luz Pasición LED - Freno LED - Intermitente Secuencial LED - Marcha Atrás LED - Antiniebla LED - Triángulo Reflectante

Function: LED Tail Lamp - LED Stop Lamp - Secuencial LED Dir. Indicator Lamp - LED Reversing Lamp - LED Fog Lamp - Triangle Reflex Reflector

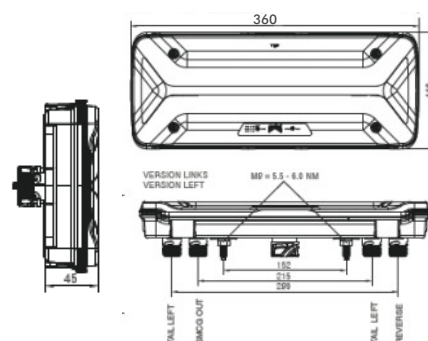

Referencia: Reference-No.	Ud. QTY	Izq. left	Dch. right	Luz Matrícula Numberplate- lamp	Descripción - Referencia O.E. Specification - O.E.-No.	Conector - Accesorios - Recambios Connector - Accessories - Spare Parts
A25-4121-007	1	■			Versión con Conector 7p ASS2 Incluye controlador intermitente acorde ECE R48 version with 7-poles connector, Sidemarker Control Gear according to ECE 48	
A25-4120-007	1		■		Versión con Conector 7p ASS2 Incluye controlador intermitente acorde ECE R48 version with 7-poles connector, Sidemarker Control Gear according to ECE 48	
A25-4121-017	1	■			Versión con Conector 7p ASS2 + 4 x 2p ASS2, Incluye controlador intermitente acorde ECE R48 version with 7-poles connector, + 4 x 2p ASS2, Sidemarker Control Gear according ECE 48	
A25-4120-017	1		■		Versión con Conector 7p ASS2 + 4 x 2p ASS2, Incluye controlador intermitente acorde ECE R48 version with 7-poles connector, + 4 x 2p ASS2, Sidemarker Control Gear according ECE 48	
A18-8536-001	1	■	■		Tulipa + tornillos Lens + screws	
A13-5626-941	1	■			Conector amarillo, para las versiones Aspöck ASS1 & ASS2 Connector yellow, for Aspöck ASS1 & ASS2 connector system	
A13-5626-951	1		■		Conector verde, para las versiones Aspöck ASS1 & ASS2 Connector green, for Aspöck ASS1 & ASS2 connector system	
A13-5626-295	1	■	■		Conector Aspöck 2P Connector 2p.	

Piloto trasero LED

LED Rear Combination Lamp

Tipo: SMARTBOX ECOLED II 12/24V

Función: Luz Pasición LED - Freno LED - Intermitente Secuencial LED - Marcha Atrás LED - Antiniebla LED - Triángulo Reflectante

Function: LED Tail Lamp - LED Stop Lamp - Secuencial LED Dir. Indicator Lamp - LED Reversing Lamp - LED Fog Lamp - Triangle Reflex Reflector

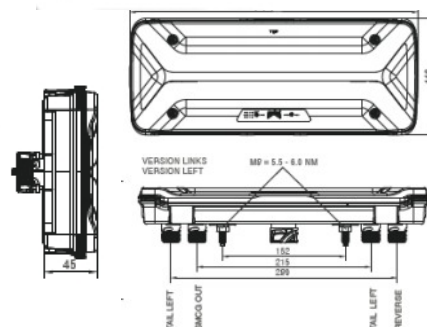

Referencia: Reference-No.	Ud. QTY	Izq. left	Dch. right	Luz Matrícula Numberplate- lamp	Descripción - Referencia O.E. Specification - O.E.-No.	Conector - Accesorios - Recambios Connector - Accessories - Spare Parts
A25-4126-001	1	■	■		Versión Ecoled II Smartbox con conector 7p ASS2 version Ecoled II Smartbox with 7-poles connector ASS2,	
A25-4126-011	1	■	■		Versión Ecoled II Smartbox con conector 7p + 4 x 2p ASS2 version Ecoled II Smartbox with 7-p + 4 2p ASS2 connector,	
A25-4126-031	1	■	■		Versión Ecoled II Smartbox con conector 7p AMP version Ecoled II Smartbox with 7-poles connector AMP,	
A25-4126-041	1	■	■		Versión Ecoled II Smartbox con conector 7p AMP,+ 4 x 2p Superseal version Ecoled II Smartbox with 7-poles connector AMP, + 4 x 2p Superseal	
A25-7537-157	1	■	■		Tapa posterior para las versiones Ecoled II y Europoint III Back cover for versions Ecoled II and Europoint III	

Piloto trasero LED

LED Rear Combination Lamp

Tipo: ECOLED II 12/24V IP6K9K

Función: Luz Pasición LED - Freno LED - Intermitente Secuencial LED - Marcha Atrás LED - Antiniebla LED - Triángulo Reflectante

Function: LED Tail Lamp - LED Stop Lamp - Secuencial LED Dir. Indicator Lamp - LED Reversing Lamp - LED Fog Lamp - Triangle Reflex Reflector

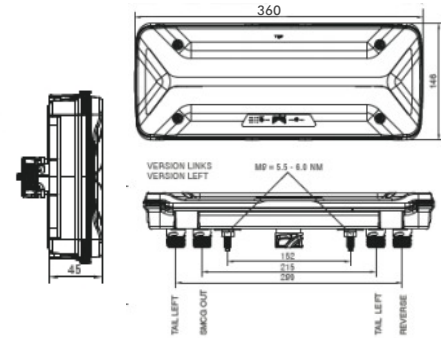
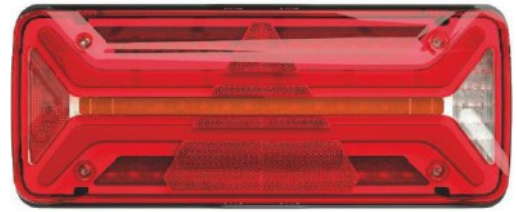

Referencia: Reference-No.	Ud. QTY	Izq. left	Dch. right	Luz Matrícula Numberplate- lamp	Descripción - Referencia O.E. Specification - O.E.-No.	Conector - Accesorios - Recambios Connector - Accessories - Spare Parts
A25-4121-037	1	■			Versión con Conector 7p AMP Incluye controlador intermitente acorde ECE R48 <i>version with 7-poles connector, Sidemarker Control Gear according to ECE 48</i>	
A25-4120-037	1		■		Versión con Conector 7p AMP Incluye controlador intermitente acorde ECE R48 <i>version with 7-poles connector, Sidemarker Control Gear according to ECE 48</i>	
A25-4121-047	1	■			Versión con Conector 7p AMP + 4 x 2p Superseal, Incluye controlador intermitente acorde ECE R48 <i>version with 7-poles connector, + 4 x 2p ASS2, Sidemarker Control Gear according ECE 48</i>	
A25-4120-047	1		■		Versión con Conector 7p AMP + 4 x 2p Superseal, Incluye controlador intermitente acorde ECE R48 <i>version with 7-poles connector, + 4 x 2p ASS2, Sidemarker Control Gear according ECE 48</i>	
A18-8536-001	1	■	■		Tulipa + tornillos <i>Lens + screws</i>	
A15-7002-024	1	■	■		Conector 7p AMP <i>Connector 7p AMP</i>	
A15-7002-044	1	■	■		Conector 2p Superseal <i>Connector 2p Superseal</i>	

Piloto trasero LED

LED Rear Combination Lamp

Tipo: ECOLED II 12/24V IP6K9K

Función: Luz Pausa LED - Freno LED - Intermitente Secuencial LED - Marcha Atrás LED - Antiniebla LED - Triángulo Reflectante

Function: LED Tail Lamp - LED Stop Lamp - Secuencial LED Dir. Indicator Lamp - LED Reversing Lamp - LED Fog Lamp - Triangle Reflex Reflector

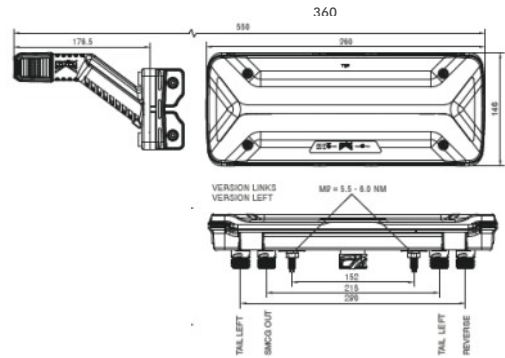

Referencia: Reference-No.	Ud. QTY	Izq. left	Dch. right	Luz Matrícula Numberplate- lamp	Descripción - Referencia O.E. Specification - O.E.-No.	Conector - Accesorios - Recambios Connector - Accessories - Spare Parts
A25-4121-027	1	■			Versión con Conector 7p ASS2 + 4 x 2p ASS2, Incluye controlador intermitente acorde ECE R48 <i>Version with 7-poles connector, Sidemarker Control Gear according to ECE 48</i>	
A25-4120-027	1		■		Versión con Conector 7p ASS2 + 4 x 2p ASS2, Incluye controlador intermitente acorde ECE R48 <i>Version with 7-poles connector, Sidemarker Control Gear according to ECE 48</i>	
A31-3103-204	1	■			Cuerno Superpoint IV + soporte Conector 2p ASS2	
A31-3102-204	1		■		End outline marker Superopoint IV withc bracket, connector 2p ASS2	
A15-5300-294	1	■	■		Soporte cuerno Superpoint IV <i>Bracket end out line market</i>	
A18-8536-001	1	■	■		Tulipa + tornillos <i>Lens + screws</i>	
A13-5626-941	1	■			Conector amarillo, para las versiones Aspöck ASS1 & ASS2 <i>Connector yellow, for Aspöck ASS1 & ASS2 connector system</i>	
A13-5626-951	1		■		Conector verde, para las versiones Aspöck ASS1 & ASS2 <i>Connector green, for Aspöck ASS1 & ASS2 connector system</i>	
A13-5626-295	1	■	■		Conector Aspöck 2P <i>Connector 2p.</i>	

Piloto trasero LED

LED Rear Combination Lamp

Tipo: ECOLED II 12/24V IP6K9K

Función: Luz Pasición LED - Freno LED - Intermitente Secuencial LED - Marcha Atrás LED - Antiniebla LED - Triángulo Reflectante

Function: LED Tail Lamp - LED Stop Lamp - Secuencial LED Dir. Indicator Lamp - LED Reversing Lamp - LED Fog Lamp - Triangle Reflex Reflector

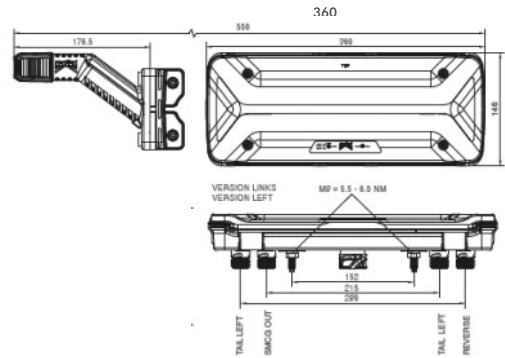

Referencia: Reference-No.	Ud. QTY	Izq. left	Dch. right	Luz Matrícula Numberplate- lamp	Descripción - Referencia O.E. Specification - O.E.-No.	Conector - Accesorios - Recambios Connector - Accessories - Spare Parts
A25-4121-057	1	■			Versión con Conector 7p AMP + 4 x 2p Superseal, Incluye controlador intermitente acorde ECE R48 <i>Version with 7-poles connector, Sidemarker Control Gear according to ECE 48</i>	
A25-4120-057	1		■		Versión con Conector 7p AMP + 4 x 2p Superseal, Incluye controlador intermitente acorde ECE R48 <i>Version with 7-poles connector, Sidemarker Control Gear according to ECE 48</i>	
A31-3103-214	1	■			Cuerno Superpoint IV + soporte Conector 2p Superseal	
A31-3102-214	1		■		End outline marker Superpoint IV with bracket, connector 2p ASS2	
A15-5300-294	1	■	■		Soporte cuerno Superpoint IV <i>Bracket end out line market</i>	
A18-8536-001	1	■	■		Tulipa + tornillos <i>Lens + screws</i>	
A15-7002-024	1	■	■		Conector 7p AMP <i>Connector 7p AMP</i>	
A15-7002-044	1	■	■		Conector 2p Superseal <i>Connector 2p Superseal</i>	

Piloto trasero LED

LED Rear Combination Lamp

Tipo: PRO-EDGE 12/24V

Función: Luz Posición LED - Freno LED - Intermitente LED - Marcha Atrás LED - Antiniebla LED - Triángulo Reflectante

Function: LED Tail Lamp - LED Stop Lamp - LED Dir. Indicator Lamp - LED Reversing Lamp - LED Fog Lamp - Triangle Reflex Reflector

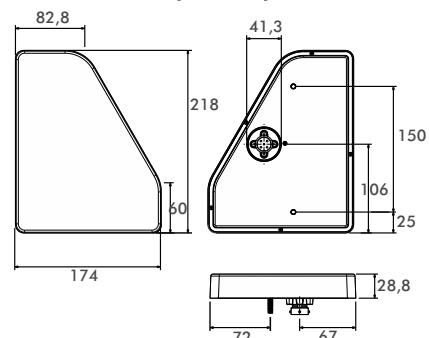

Referencia: Reference-No.	Ud. QTY	Izq. left	Dch. right	Luz Matrícula Numberplate- lamp	Descripción - Referencia O.E. Specification - O.E.-No.	Conector - Accesorios - Recambios Connector - Accessories - Spare Parts
P40.238.211	1	■			Versión con conector 5p y con Antiniebla <i>version connector 5-poles with Fog Lamp</i>	
P40.238.212	1		■		Versión con conector 5p y con Marcha Atrás <i>version connector 5-poles with Reversing Lamp</i>	
A13-0546-004	1	■	■		Kit Bayoneta 5p. <i>Repairkit 5-poles, female</i>	
P50.141.212 12V	1	■	■		Pre-montado Control de LED supervisa Intermitente, con cable de 0,3m + conector 5P. <i>Pre-assembled LED Control Gear monitors Dir. Indicator function, cable 0,3m + 5-pole con.</i>	+ info. página 9.2.0 PRO-CONTROL <i>see page 9.2.0</i>
P50.140.212 12V	1	■	■		Controlador LED pre-montado supervisa el intermitente y comprueba las luces de posición-freno-niebla-luz de marcha atrás LED. <i>Pre-assembled LED Control Kit monitors the direction indicator lamp and is checking the stop-tail-fog-reversing lamp</i>	+ info. página 9.2.0 PRO-LCG <i>see page 9.2.0</i>

Possibilidades de ajuste con la centralita de control LED:
Plug & Play PRO-EDGE

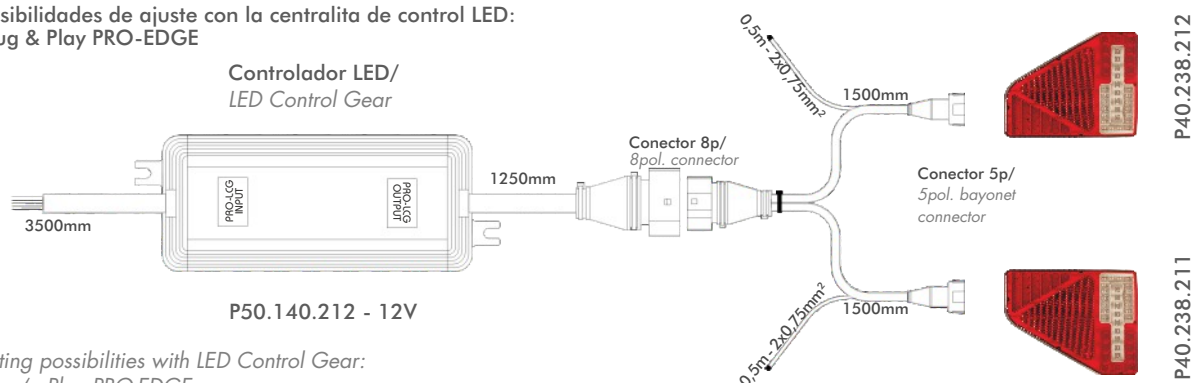

Fitting possibilities with LED Control Gear:
Plug 'n Play PRO-EDGE

NEW

ASPÖCK
IBERICA

PROPLAST

FAHRZEUGBELEUCHTUNG

www.aspock.com

Catálogo 2022/2023

Página 1.47.1

Piloto trasero LED





LED Rear Combination Lamp

Tipo: PRO-LANE III

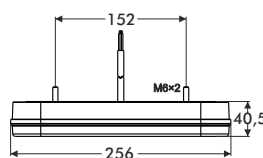
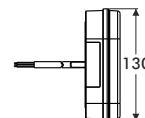
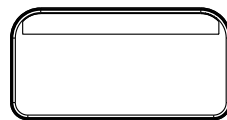
Función: Posición LED - Frenos LED - Intermitente LED -
Marcha atrás LED - Antiniebla LED - Catadióptico
Opción con Controlador intermitente 12/24V (LCG)

Function: LED Tail Lamp - LED Stop Lamp - LED Dir. Indicator Lamp -
LED Reversing Lamp - LED Fog Lamp -
Triangle Reflex Reflector
Opt. 12/24V Flasher control unit (LCG)



Referencia: Reference-No.	Ud. QTY	Izq. left	Dch. right	Luz Matrícula Numberplate- lamp	Descripción - Referencia O.E. Specification - O.E.-No.	Conector - Accesorios - Recambios Connector - Accessories - Spare Parts
P40.706.011	1	■			Luz de Posición Guía de Led Carcasa: ABS+PC Tulipa: PMMA+PC Conexión: 2,0m puntas abiertas Voltaje: 12/24 Volt Protección: IP6K9K Homolog.: ECE EMV Intermitente: 12V-2,2W / 24V-2,2W Posición: 12V-1,8W / 24V-1,8W Freno: 12V-1,5W / 24V-1,5W Niebla: 12V-2,2W / 24V-2,2W M. atrás: 12V-4,0W / 24V-4,0W	
P40.706.012	1		■		LED Tail Lamp in Light guide technology Housing: ABS+PC Lens: PMMA Cable: 2,0m open end Voltage: 12/24 Volt Protection: IP6K9K Homologation: ECE approved EMC approved Dir. Indicator: 12V-2,2W / 24V-2,2W Tail: 12V-1,8W / 24V-1,8W Stop: 12V-1,5W / 24V-1,5W Fog: 12V-2,2W / 24V-2,2W Reverse: 12V-4,0W / 24V-4,0W	
P40.706.911	1	■			Luz de Posición Guía de Led Controlador LED integrado Carcasa: ABS+PC Tulipa: PMMA+PC Conexión: 2,0m puntas abiertas Voltaje: 12/24 Volt Protección: IP6K9K Homolog.: ECE EMV Intermitente: 12V-3,5W / 24V-3,5W Posición: 12V-3,2W / 24V-3,2W Freno: 12V-2,0W / 24V-2,0W Niebla: 12V-4,0W / 24V-4,0W M. atrás: 12V-2,5W / 24V-2,5W	 
P40.706.912	1		■		LED Tail Lamp in Light guide technology integr. LED Control Gear 12/24V Housing: ABS+PC Lens: PMMA Cable: 2,0m open end Voltage: 12/24 Volt Protection: IP6K9K Homologation: ECE approved EMC approved Dir. Indicator: 12V-21,0W / 24V-21,0W Tail: 12V-1,8W / 24V-1,8W Stop: 12V-1,5W / 24V-1,5W Fog: 12V-2,2W / 24V-2,2W Reverse: 12V-4,0W / 24V-4,0W	 

Piloto trasero LED

LED Rear Combination Lamp

Tipo: **PRO-LANE 12/24V IP6K9K**

Función: Luz Pasi3n LED - Freno LED - Intermitente
LED - Marcha Atrás LED - Antiniebla LED - Triángulo
Reflectante

Function: LED Tail Lamp - LED Stop Lamp - LED Dir. Indicator Lamp -
LED Reversing Lamp - LED Fog Lamp -
Triangle Reflex Reflector

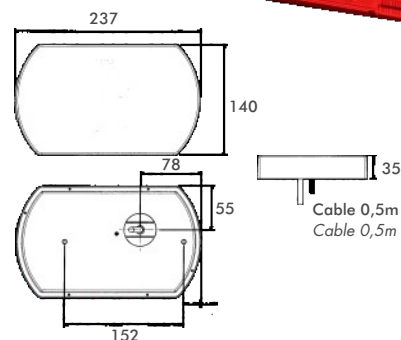

Referencia: Reference-No.	Ud. QTY	Izq. left	Dch. right	Luz Matrícula Numberplate- lamp	Descripci3n - Referencia O.E. Specification - O.E.-No.	Conector - Accesorios - Recambios Connector - Accessories - Spare Parts
P40.291.011	1	■		■ lateral/ lateral	Versi3n con Cable 2m con Antiniebla <i>version cable 2,0m with Fog Lamp</i>	
P40.291.013	1		■	■ lateral/ lateral	Versi3n con Cable 2m con Marcha Atrás <i>version cable 2,0m with Reversing Lamp</i>	
P40.291.311	1	■			Versi3n con Cable 2m con Antiniebla <i>version cable 2,0m with Fog Lamp</i>	
P40.291.313	1		■		Versi3n con Cable 2m con Marcha Atrás <i>version cable 2,0m with Reversing Lamp</i>	
P50.140.012 12V	1	■	■		Controlador LED, intermitente - posici3n- freno - antiniebla- marcha atrás, 2pilotos <i>LED Control Gear monitors the direction indicator lamp and is checking the stop-tail-fog- reversing lamp</i>	+ info. página 9.0.0 PRO-LCG
P50.140.024 24V	1					see page 9.0.0
P50.141.012 12V	1	■	■		Controlador LED especial Intermitente <i>LED Control Gear Direction Indicator function</i>	+ info. página 9.0.0 PRO-CONTROL
P50.141.024 24V	1					see page 9.0.0
P50.139.012 12V	1	■	■		Controlador LED funciones 21W <i>LED Control Gear monitors the 21W functions</i>	+ info. página 9.3.0 PRO-LOAD
P50.139.024 24V	1					see page 9.3.0
P50.125.524 24V	1	■	■		Cotrolador LED Para las funciones de posici3n. <i>LED Control Gear Tail Light function</i>	+ info. página 9.3.0 see page 9.3.0

Piloto trasero LED

LED Rear Combination Lamp

Tipo: PRO-LANE II 12V

Función: Luz Posición LED - Freno LED - Intermitente LED - Marcha Atrás LED - Antiniebla LED - Triángulo Reflectante

Function: LED Tail Lamp - LED Stop Lamp - LED Dir. Indicator Lamp - LED Reversing Lamp - LED Fog Lamp - Triangle Reflex Reflector

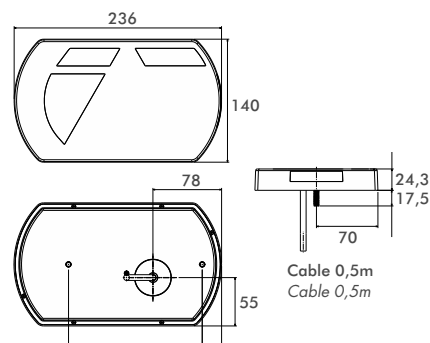

Referencia: Reference-No.	Ud. QTY	Izq. left	Dch. right	Luz Matrícula Numberplate- lamp	Descripción - Referencia O.E. Specification - O.E.-No.	Conector - Accesorios - Recambios Connector - Accessories - Spare Parts
P40.297.011	1	■		■ lateral/ lateral	Versión con Cable 2m con Antiniebla version cable 2,0m with Fog Lamp	
P40.297.013	1		■	■ lateral/ lateral	Versión con Cable 2m con Marcha Atrás version cable 2,0m with Reversing Lamp	
P40.297.211	1	■		■ lateral/ lateral	Versión con Conector 5p con Antiniebla version connector 5-poles with Fog Lamp	
P40.297.213	1		■	■ lateral/ lateral	Versión con Conector 5p con Marcha Atrás version connector 5-poles with Reversing Lamp	
P40.297.311	1	■			Versión con Cable 2m con Antiniebla version cable 2,0m with Fog Lamp	
P40.297.313	1		■		Versión con Cable 2m con Marcha Atrás version cable 2,0m with Reversing Lamp	
P50.140.012 12V	1	■	■		Controlador LED, intermitente - posición- freno - antiniebla- marcha atrás, 2pilotos LED Control Gear monitors the direction indicator lamp and is checking the stop-tail-fog- reversing lamp	+ info. página 9.0.0 PRO-LCG see page 9.0.0
P50.141.012 12V	1	■	■		Controlador LED especial Intermitente LED Control Gear Direction Indicator function	+ info. página 9.0.0 PRO-CONTROL see page 9.0.0

Piloto trasero LED

LED Rear Combination Lamp

Tipo: LC-12 12/24V

Función: Luz Posición LED - Freno LED - Intermitente Secuencial LED - Marcha Atrás LED - Antiniebla LED - Triángulo Reflectante



Function: LED Tail Lamp - LED Stop Lamp - LED Sequential Indicator Lamp - LED Reversing Lamp - LED Fog Lamp - Triangle Reflex Reflector

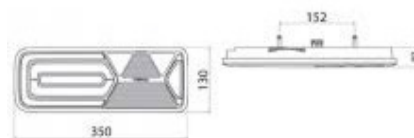

Referencia: Reference-No.	Ud. QTY	Izq. left	Dch. right	Luz Matrícula Numberplate- lamp	Descripción - Referencia O.E. Specification - O.E.-No.	Conector - Accesorios - Recambios Connector - Accessories - Spare Parts
P50.200.050 24V	1	■			Versión con conector 7p AMP, Intermitente secuencial y con controlador LED integrado version 7p AMP connector, Sequential direction indicator integrated flasher control unit, LED control gear	
P50.200.051 24V	1		■		Versión con conector 7p AMP, Intermitente secuencial y con controlador LED integrado version 7p AMP connector, Sequential direction indicator integrated flasher control unit, LED control gear	

Piloto trasero LED

LED Rear Combination Lamp

Tipo: ECOLED 24V IP69K

Función: Luz Pasiación LED - Freno LED - Intermitente LED - Marcha Atrás LED - Antiniebla LED - Balizamiento lateral LED - Triángulo Reflectante

Function: LED Tail Lamp - LED Stop Lamp - LED Dir. Indicator Lamp - LED Reversing Lamp - LED Fog Lamp - LED Side Marker Lamp - Triangle Reflex Reflector

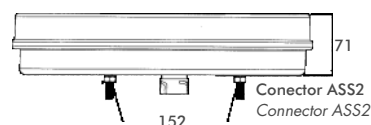
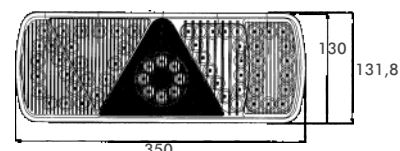

Referencia: Reference-No.	Ud. QTY	Izq. left	Dch. right	Luz Matrícula Numberplate- lamp	Descripción - Referencia O.E. Specification - O.E.-No.	Conector - Accesorios - Recambios Connector - Accessories - Spare Parts
A25-3800-501	1	■			Aspöck O.E. 25-3800-507 Versión con conector Aspöck ASS2 version with Aspöck ASS2 connector	
A25-3900-501	1		■		Aspöck O.E. 25-3900-507 Versión con conector Aspöck ASS2 version with Aspöck ASS2 connector	
A25-3800-511	1	■			Aspöck O.E. 25-3800-517 Versión con conector 7p ASS2.1 + 2x2p ASS2 version with 7p ASS2.1 + 2x2p connector ASS" connector	
A25-3900-511	1		■		Aspöck O.E. 25-3900-517 Versión con conector 7p ASS2.1 + 2x2p ASS2 version with 7p ASS2.1 + 2x2p connector ASS" connector	
A75-0300-001	1	■	■		Controlador LED 24V con conector Aspöck ASS2, para las funciones de Freno - Posición - Intermitente LED Control Gear, Aspöck ASS2 for Stop-Tail-Dir.Indicator function	
A13-5626-941	1	■			Conector amarillo, para las versiones Aspöck ASS1 & ASS2 Connector yellow, for Aspöck ASS1 & ASS2 connector system	
A13-5626-951	1		■		Conector verde, para las versiones Aspöck ASS1 & ASS2 Connector green, for Aspöck ASS1 & ASS2 connector system	

Piloto trasero LED

LED Rear Combination Lamp

Tipo: ECOLED 24V IP69K

Función: Luz Pación LED - Freno LED - Intermitente LED - Marcha Atrás LED - Antiniebla LED - Triángulo Cuerno lateral LED - Reflectante

Function: LED Tail Lamp - LED Stop Lamp - LED Dir. Indicator Lamp - LED Reversing Lamp - LED Fog Lamp - LED End Outline Marker Lamp - Triangle Reflex Reflector

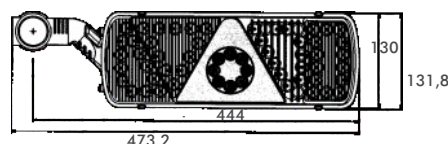

Conector 2p ASS2 Conector 7p ASS2 Conector 2-pol. ASS2
Connector 2-pol. ASS2 Connector 7-pol. ASS2 Connector 2-pol. ASS2
Connector 7-pol. ASS2

Referencia: Reference-No.	Ud. QTY	Izq. left	Dch. right	Luz Matrícula Numberplate- lamp	Descripción - Referencia O.E. Specification - O.E.-No.	Conector - Accesorios - Recambios Connector - Accessories - Spare Parts
A25-3820-511	1	■			Aspöck O.E. 25-3820-517 Versión con conector 7p ASS2.1 + 2x2p ASS2 Aspöck connector system ASS2, 1 x 7-poles, 2 x 2-poles	
A25-3920-511	1		■		Aspöck O.E. 25-3920-517 Versión con conector 7p ASS2.1 + 2x2p ASS2 Aspöck connector system ASS2, 1 x 7-poles, 2 x 2-poles	
A31-3305-231		■			Aspöck O.E. 31-3305-237 Gálibo LED Superpoint III CORTO	
A31-3306-231			■		Aspöck O.E. 31-3306-237 Gálibo LED Superpoint III CORTO	
A31-3305-244		■			Aspöck O.E. 31-3305-247 Gálibo LED Superpoint III LARGO	
A31-3306-244			■		Aspöck O.E. 31-3306-247 Gálibo LED Superpoint III LARGO	
A75-0300-001	1	■	■		Controlador LED 24V con conector Aspöck ASS2, para las funciones de Freno - Posición - Intermitente LED Control Gear, Aspöck ASS2 for Stop-Tail-Dir.Indicator function	
A13-5626-941	1	■			Conector amarillo, para las versiones Aspöck ASS1 & ASS2 Connector yellow, for Aspöck ASS1 & ASS2 connector system	
A13-5626-951	1		■		Conector verde, para las versiones Aspöck ASS1 & ASS2 Connector green, for Aspöck ASS1 & ASS2 connector system	

Piloto Trasero Híbrido

Hybrid Rear Combination Lamp

Tipo: EUROPOINT III 24V IP56K

Función: Luz Posición LED - Freno - Intermitente -
Marcha Atrás - Antiniebla - Luz Balizamiento
lateral - Triángulo Reflectante

Function: LED Tail Lamp - Stop Lamp - Dir. Indicator Lamp -
Reversing Lamp - Fog Lamp - Side Marker Lamp -
Triangle Reflex Reflector

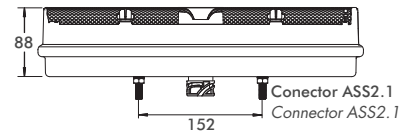
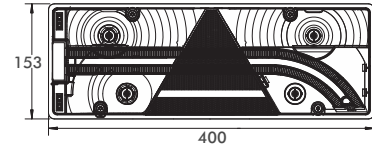

Referencia: Reference-No.	Ud. QTY	Izq. left	Dch. right	Luz Matrícula Numberplate- lamp	Descripción - Referencia O.E. Specification - O.E.-No.	Conector - Accesorios - Recambios Connector - Accessories - Spare Parts
A25-7000-501	1	■			Aspöck O.E.: A25-7000-507 Versión con conector ASS2.1 <i>version with ASS2 connector</i>	
A25-7400-501	1		■		Aspöck O.E.:A25-7400-507 Versión con conector ASS2.1 <i>version with ASS2 connector</i>	
A25-7000-511	1	■			Aspöck O.E.: A25-7000-517 Versión conector 7p ASS2.1 +4x2p ASS2 <i>version with ASS2 7p + 4x2p ASS2 connector</i>	
A25-7400-511	1		■		Aspöck O.E.: A25-7400-517 Versión conector 7p ASS2.1 +4x2p ASS2 <i>version with ASS2 7p + 4x2p ASS2 connector</i>	
A18-8570-001	1	■			Tulipa sin Luz de Matrícula <i>Lens</i>	
A18-8570-101	1		■		Tulipa sin Luz de Matrícula <i>Lens</i>	
A12-1570-001	1	■			Recambio Guía de LED <i>LED insert</i>	
A12-1570-101	1		■		Recambio Guía de LED <i>LED insert</i>	
A13-5626-941	1	■			Conector amarillo, para las versiones Aspöck ASS1 & ASS2 <i>Connector yellow, for Aspöck ASS1 & ASS2 connector system</i>	
A13-5626-951	1		■		Conector verde, para las versiones Aspöck ASS1 & ASS2 <i>Connector green, for Aspöck ASS1 & ASS2 connector system</i>	

Piloto Trasero Híbrido









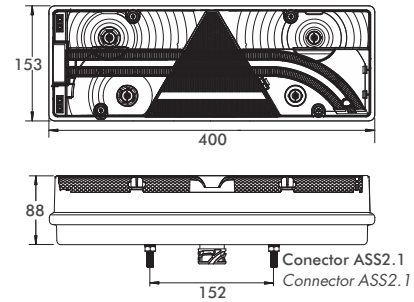

Hybrid Rear Combination Lamp

Tipo: EUROPOINT III 24V IP56K

Función: Luz Posición LED - Freno - Intermitente -
Marcha Atrás - Antiniebla - Luz Balizamiento
lateral - Triángulo Reflectante

Function: LED Tail Lamp - Stop Lamp - Dir. Indicator Lamp -
Reversing Lamp - Fog Lamp - Side Marker Lamp -
Triangle Reflex Reflector



Referencia: Reference-No.	Ud. QTY	Izq. left	Dch. right	Luz Matrícula Numberplate- lamp	Descripción - Referencia O.E. Specification - O.E.-No.	Conector - Accesorios - Recambios Connector - Accessories - Spare Parts
A25-7001-501	1	■		■	Aspöck O.E.: A25-7001-507 Versión con conector ASS2.1 <i>version with ASS2.1 connector</i>	Fabricantes: SEM. ROJO INDETRUCK 
A25-7401-531	1		■	■	Aspöck O.E. 25-7401-537 Versión con conector ASS2.1 + Avisador acústico <i>version with ASS2.1 connector + reverse alarm</i>	Fabricantes: SEM. ROJO INDETRUCK 
A25-7001-601	1	■		■	Aspöck O.E.: A25-7001-607 Versión conector 7p ASS2.1 + 4x2p ASS2 <i>version with ASS2 7p + 4x2p ASS2 connector</i>	 Fabricante: LECITRAILER
A25-7401-601	1		■	■	Aspöck O.E.: A25-7401-607 Versión conector 7p ASS2.1 + 4x2p ASS2 + Avis. Acústico <i>version with ASS2 7p + 4x2p ASS2 connector</i>	 Fabricante: LECITRAILER
A25-7001-617	1	■		■	Versión FULL LED excepto luz de matrícula, conector 7p ASS2.1 + 4x2p ASS2	
A25-7401-617	1		■	■	Versión FULL LED excepto luz de matrícula, conector 7p ASS2.1 + 4x2p ASS2 + Avis. Acústico	
A18-8570-011	1	■			Recambio Guía de LED <i>LED insert</i>	
A18-8570-111	1		■		Recambio Guía de LED <i>LED insert</i>	
A13-5626-941	1	■			Conector amarillo, para las versiones Aspöck ASS1 & ASS2 <i>Connector yellow, for Aspöck ASS1 & ASS2 connector system</i>	
A13-5626-951	1		■		Conector verde, para las versiones Aspöck ASS1 & ASS2 <i>Connector green, for Aspöck ASS1 & ASS2 connector system</i>	
A13-5626-951	1	■	■		Conector 2P ASS2 <i>Connector ASS2 2p.</i>	

Piloto Trasero LED

LED Rear Combination Lamp

Tipo: EUROPOINT III 24V IP56K

Función: Luz Posición LED - Módulo Freno LED -
Módulo Intermitente LED - Módulo Marcha Atrás LED -
Módulo Antiniebla LED - Módulo Luz Balizamiento
lateral LED - Triángulo Reflectante

Function: LED Tail Lamp - LED Stop Lamp - LED Dir. Indicator Lamp -
LED Reversing Lamp - LED Fog Lamp - LED Side Marker
Lamp - Triangle Reflex Reflector

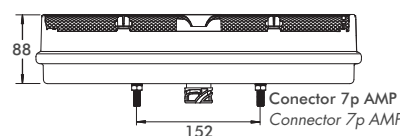
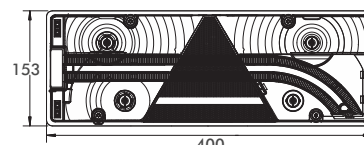

Referencia: Reference-No.	Ud. QTY	Izq. left	Dch. right	Luz Matrícula Numberplate- lamp	Descripción - Referencia O.E. Specification - O.E.-No.	Conector - Accesorios - Recambios Connector - Accessories - Spare Parts
A25-7030-711	1	■			Aspöck O.E.: A25-7030-717 Versión conector 7p AMP + 4x2p SUPERSEAL version with 7p AMP + 4x2p supersesal connector	Fabricante: SCHMITZ
A25-7430-711	1		■		Aspöck O.E.: A25-7430-717 Versión conector 7p AMP + 4x2p SUPERSEAL version with 7p AMP + 4x2p supersesal connector	
A25-7030-721	1	■			Aspöck O.E.: A25-7030-727 Versión conector 7p AMP + 4x2p SUPERSEAL version with 7p AMP + 4x2p supersesal connector	 Controlador LED Intermitente incluido
A25-7430-721	1		■		Aspöck O.E.: A25-7430-727 Versión conector 7p AMP + 4x2p SUPERSEAL version with 7p AMP + 4x2p supersesal connector	 Controlador LED Intermitente incluido
A18-8570-001	1	■			Tulipa sin Luz de Matrícula Lens	
A18-8570-101	1		■		Tulipa sin Luz de Matrícula Lens	
A12-1570-001	1	■			Recambio Guía de LED LED insert	
A12-1570-101	1		■		Recambio Guía de LED LED insert	
P50.071.100	1	■			Conector 7p AMP Connector yellow, for Aspöck ASS1 & ASS2 connector system	
P50.079.200	1		■		Conector 2p AMP Connector green, for Aspöck ASS1 & ASS2 connector system	

Módulos LED Europoint III

LED Moduls for Europoint III

Tipo: EUROPOINT III 24V IP56K

Función: Luz Posición LED - Módulo Freno LED -
 Módulo Intermitente LED - Módulo Marcha Atrás LED -
 Módulo Antiniebla LED - Módulo Luz Balizamiento
 lateral LED - Triángulo Reflectante

Function: LED Tail Lamp - LED Stop Lamp - LED Dir. Indicator Lamp -
 LED Reversing Lamp - LED Fog Lamp - LED Side Marker
 Lam - Triangle Reflex Reflector

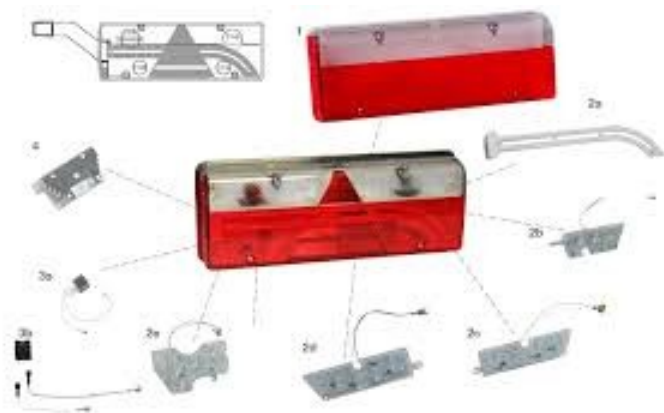

Referencia: Reference-No.	Ud. QTY	Izq. left	Dch. right	Luz Matrícula Numberplate- lamp	Descripción - Referencia O.E. Specification - O.E.-No.	Conector - Accesorios - Recambios Connector - Accessories - Spare Parts
A12-1570-204	1	■			Aspöck O.E. 12-1570-207 Módulo Freno LED <i>Stop LED</i>	
A12-1574-204	1		■		Aspöck O.E. 12-1574-207 Módulo Freno LED <i>Stop LED</i>	
A12-1570-214	1	■			Aspöck O.E. 12-1570-217 Módulo Antiniebla LED <i>Lens</i>	
A12-1574-214	1		■		Aspöck O.E. 12-1574-217 Módulo Antiniebla LED <i>Lens</i>	
A12-1570-224	1	■			Aspöck O.E. 12-1570-227 Módulo Intermitente LED <i>LED insert</i>	
A12-1574-224	1		■		Aspöck O.E. 12-1574-227 Módulo Intermitente LED <i>LED insert</i>	
A12-1570-234	1	■			Aspöck O.E. 12-1570-237 Módulo Marcha Atrás LED <i>Connector yellow, for Aspöck ASS1 & ASS2 connector system</i>	
A12-1574-234	1		■		Aspöck O.E. 12-1574-237 Módulo Marcha Atrás LED <i>Connector green, for Aspöck ASS1 & ASS2 connector system</i>	
A15-5270-007	1					
A25-7537-157		■	■			
A15-5276-007						
					O.E.: A15-5270-007	O.E.: A25-7537-157
					O.E.: A15-5276-007	

Piloto Trasero LED

LED Rear Combination Lamp

Tipo: EUROPOINT III 24V IP56K

Función: Luz Posición LED - Módulo Freno LED -
Módulo Intermitente LED - Módulo Marcha Atrás LED -
Módulo Antiniebla LED - Módulo Luz Balizamiento
lateral LED - Triángulo Reflectante

Function: LED Tail Lamp - LED Stop Lamp - LED Dir. Indicator Lamp -
LED Reversing Lamp - LED Fog Lamp - LED Side Marker
Lam - Triangle Reflex Reflector

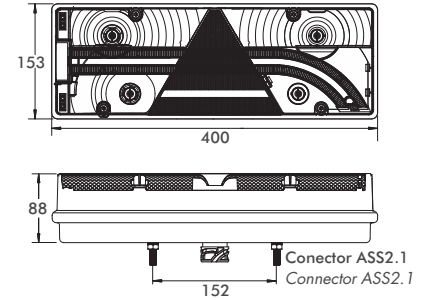

Referencia: Reference-No.	Ud. QTY	Izq. left	Dch. right	Luz Matrícula Numberplate- lamp	Descripción - Referencia O.E. Specification - O.E.-No.	Conector - Accesorios - Recambios Connector - Accessories - Spare Parts
A25-7000-701	1	■			Aspöck O.E.: A25-7000-707 Versión con conector ASS2.1 <i>version with ASS2.1 connector</i>	
A25-7400-701	1		■		Aspöck O.E. 25-7400-707 Versión con conector ASS2.1 <i>version with ASS2.1 connector + reverse alarm</i>	
A25-7000-711	1	■			Aspöck O.E.: A25-7000-717 Versión conector 7p ASS2.1 + 4x2p ASS2 <i>version with ASS2 7p + 4x2p ASS2 connector</i>	
A25-7400-711	1		■		Aspöck O.E.: A25-7400-717 Versión conector 7p ASS2.1 + 4x2p ASS2 <i>version with ASS2 7p + 4x2p ASS2 connector</i>	
A25-7000-741	1	■			Aspöck O.E.: A25-7000-747 Versión con conector ASS2.1 <i>version with ASS2.1 connector</i>	Controlador LED Intermitente incluido
A25-7400-741	1		■		Aspöck O.E. 25-7400-747 Versión con conector ASS2.1 <i>version with ASS2.1 connector + reverse alarm</i>	Controlador LED Intermitente incluido
A18-8570-001	1	■			Tulipa sin Luz de Matrícula <i>Lens</i>	
A18-8570-101	1		■		Tulipa sin Luz de Matrícula <i>Lens</i>	
A13-5626-941	1	■			Conector amarillo, para las versiones Aspöck ASS1 & ASS2 <i>Connector yellow, for Aspöck ASS1 & ASS2 connector system</i>	
A13-5626-951	1		■		Conector verde, para las versiones Aspöck ASS1 & ASS2 <i>Connector green, for Aspöck ASS1 & ASS2 connector system</i>	
A13-5626-951	1	■	■		Conector 2P ASS2 <i>Connector ASS2 2p.</i>	

Piloto Trasero Híbrido

Hybrid Rear Combination Lamp

Tipo: EUROPOINT III 24V IP56K

Función: Luz Posición LED - Freno - Intermitente -
Marcha Atrás - Antiniebla - Luz Balizamiento
lateral - Triángulo Reflectante

Function: LED Tail Lamp - LED Stop Lamp - LED Dir. Indicator Lamp -
LED Reversing Lamp - LED Fog Lamp - LED Side Marker
Lam - Triangle Reflex Reflector

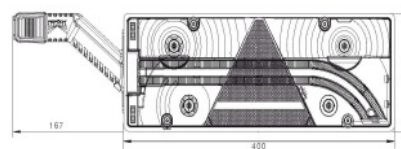

Conector Aspöck ASS2
Connector ASS2

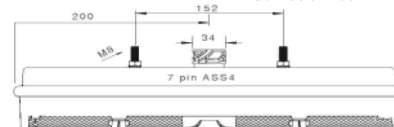

Referencia: Reference-No.	Ud. QTY	Izq. left	Dch. right	Luz Matrícula Numberplate- lamp	Descripción - Referencia O.E. Specification - O.E.-No.	Conector - Accesorios - Recambios Connector - Accessories - Spare Parts
A25-7020-501	1	■			Aspöck O.E.: A25-7020-507 Versión con 1 conector 7p ASS2 version with 7p ASS2 connector	
A25-7420-501	1		■		Aspöck O.E.: A25-7420-507 Versión con 1 conector 7p ASS2 version with 7p ASS2 connector	
A25-7020-541	1	■		■	Aspöck O.E.: A25-7020-547 Versión con 1 conector 7p ASS2 version with 7p ASS2 connector	Fabricantes: Parcisa / Farcinox
A25-7420-541	1		■	■	Aspöck O.E.: A25-7420-547 Versión con 1 conector 7p ASS2 version with 7p ASS2 connector	
A18-8570-011	1	■		■	Tulipa con Luz de Matrícula Lens	
A18-8570-111	1		■	■	Tulipa con Luz de Matrícula Lens	
A12-1570-001	1	■			Recambio Guía de LED Led Insert	
A12-1570-101	1		■		Recambio Guía de LED Led Insert	
A31-3105-004	1	■			Aspöck O.E. 31-3105-007	
A31-3106-004	1		■		Aspöck O.E. 31-3106-007	
A13-5626-941	1	■			Conector amarillo, para las versiones Aspöck ASS1 & ASS2 Connector yellow, for Aspöck ASS1 & ASS2 connector system	
A13-5626-951	1		■		Conector verde, para las versiones Aspöck ASS1 & ASS2 Connector green, for Aspöck ASS1 & ASS2 connector system	

Piloto Trasero Híbrido

Hybrid Rear Combination Lamp

Tipo: EUROPOINT III 24V IP56K

Función: Luz Posición LED - Freno - Intermitente -
Marcha Atrás - Antiniebla - Luz Balizamiento
lateral - Triángulo Reflectante

Function: LED Tail Lamp - LED Stop Lamp - LED Dir. Indicator Lamp -
LED Reversing Lamp - LED Fog Lamp - LED Side Marker
Lam - Triangle Reflex Reflector

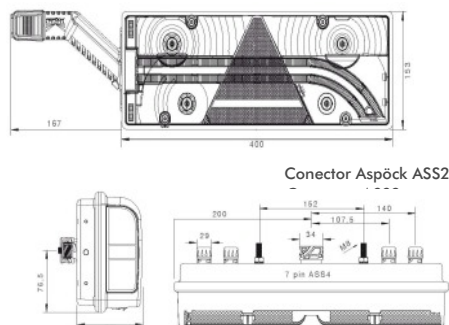

Referencia: Reference-No.	Ud. QTY	Izq. left	Dch. right	Luz Matrícula Numberplate- lamp	Descripción - Referencia O.E. Specification - O.E.-No.	Conector - Accesorios - Recambios Connector - Accessories - Spare Parts
A25-7020-511	1	■			Aspöck O.E.: A25-7020-517 Versión conector 7p ASS2.1 + 4 conectores 2p ASS2 ver. 7p ASS2 + 4x2p connector	
A25-7420-511	1		■		Aspöck O.E.: A25-7420-517 Versión conector 7p ASS2.1 + 4 conectores 2p ASS2 ver. 7p ASS2 + 4x2p connector	
A25-7021-511	1	■		■	Aspöck O.E.:A25-7021-517 Versión con 1 conector 7p ASS2 ver. 7p ASS2 + 4x2p connector	Fabricantes: LECITRAILER PRIMBALL / SICAL
A25-7421-521	1		■	■	Aspöck O.E.: A25-7421-527 Versión con 1 conector 7p ASS2 ver. 7p ASS2 + 4x2p connector	Fabricantes: LECITRAILER PRIMBALL / SICAL
A18-8570-011	1	■		■	Tulipa con Luz de Matrícula Lens	
A18-8570-111	1		■	■	Tulipa con Luz de Matrícula Lens	
A18-8570-001	1	■			Tulipa sin Luz de Matrícula Led Insert	
A18-8570-101	1		■		Tulipa sin Luz de Matrícula Led Insert	
A31-3105-004	1	■			Aspöck O.E. 31-3105-007	
A31-3106-004	1		■		Aspöck O.E. 31-3106-007	
A13-5626-941	1	■			Conector amarillo, para las versiones Aspöck ASS1 & ASS2 Connector yellow, for Aspöck ASS1 & ASS2 connector system	
A13-5626-951	1		■		Conector verde, para las versiones Aspöck ASS1 & ASS2 Connector green, for Aspöck ASS1 & ASS2 connector system	
A13-5626-951	1	■	■		Conector 2p ASS2 2p ASS2 connector	

Piloto Trasero LED

Hybrid Rear Combination Lamp

Tipo: EUROPOINT III 24V IP56K

Función: Luz Posición LED - Módulo Freno LED -
Módulo Intermitente LED - Módulo Marcha Atrás LED -
Módulo Antiniebla LED - Módulo Luz Balizamiento
lateral LED - Triángulo Reflectante

Function: LED Tail Lamp - LED Stop Lamp - LED Dir. Indicator Lamp -
LED Reversing Lamp - LED Fog Lamp - LED Side Marker
Lam - Triangle Reflex Reflector

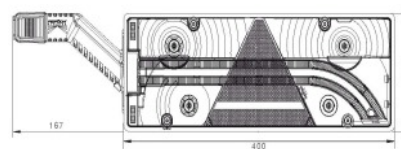

Conector Aspöck ASS2
Connector ASS2

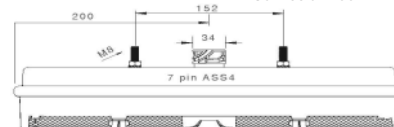

Referencia: Reference-No.	Ud. QTY	Izq. left	Dch. right	Luz Matrícula Numberplate- lamp	Descripción - Referencia O.E. Specification - O.E.-No.	Conector - Accesorios - Recambios Connector - Accessories - Spare Parts
A25-7020-701	1	■			Aspöck O.E.: A25-7020-707 Versión con 1 conector 7p ASS2 version with 7p ASS2 connector	
A25-7420-701	1		■		Aspöck O.E.: A25-7420-707 Versión con 1 conector 7p ASS2 version with 7p ASS2 connector	
A25-7020-711	1	■			Aspöck O.E.: A25-7020-717 Versión conector 7p ASS2.1 + 4 conectores 2p ASS2 version with 7p ASS2 connector + 4 connector 2 poles	
A25-7420-711	1		■		Aspöck O.E.: A25-7420-717 Versión conector 7p ASS2.1 + 4 conectores 2p ASS2 version with 7p ASS2 connector + 4 connector 2 poles	
A25-7020-731	1	■			Aspöck O.E.: A25-7020-737 Versión con 1 conector 7p ASS2 version with 7p ASS2 connector	Controlador LED Intermitente incluido
A25-7420-761	1	■			Aspöck O.E.: A25-7420-767 Versión con 1 conector 7p ASS2 version with 7p ASS2 connector	Controlador LED Intermitente incluido
A18-8570-001	1	■			Tulipa sin Luz de Matrícula Lens	
A18-8570-101	1		■		Tulipa sin Luz de Matrícula Lens	
A31-3105-004	1	■			Aspöck O.E. 31-3105-007	
A31-3106-004	1		■		Aspöck O.E. 31-3106-007	
A13-5626-941	1	■			Conector amarillo, para las versiones Aspöck ASS1 & ASS2 Connector yellow, for Aspöck ASS1 & ASS2 connector system	
A13-5626-951	1		■		Conector verde, para las versiones Aspöck ASS1 & ASS2 Connector green, for Aspöck ASS1 & ASS2 connector system	

Piloto Trasero LED

LED Rear Combination Lamp

Tipo: 5 FUNCIONES LED 12/24V IP67

Función: Luz Posición LED - Freno LED - Intermitente LED -
Marcha Atrás LED - Antiniebla LED - Triángulo
Reflectante

Function: LED Tail Lamp - LED Stop Lamp - LED Dir. Indicator Lamp -
LED Reversing Lamp - LED Fog Lamp - Triangle Reflex

Reflector

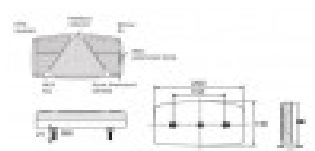

Referencia: Reference-No.	Ud. QTY	Izq. left	Dch. right	Luz Matrícula Numberplate- lamp	Descripción - Referencia O.E. Specification - O.E.-No.	Conector - Accesorios - Recambios Connector - Accessories - Spare Parts
FA41-1300-011	1	■			Versión con cable 0.4m version with 0.4m cable	
FA41-1300-121	1		■		Versión con cable 0.4m version with 0.4m cable	

Piloto Trasero LED

LED Rear Combination Lamp

Tipo: 6 FUNCIONES LED 12/24V IP67

Función: Luz Posición LED - Freno LED - Intermitente LED -
Marcha Atrás LED - Antiniebla LED - Balizamiento
Lateral LED - Triángulo Reflectante

Function: LED Tail Lamp - LED Stop Lamp - LED Dir. Indicator Lamp -
LED Reversing Lamp - LED Fog Lamp - LED Side market -
Reflex Reflector

Triangle Reflex Reflector

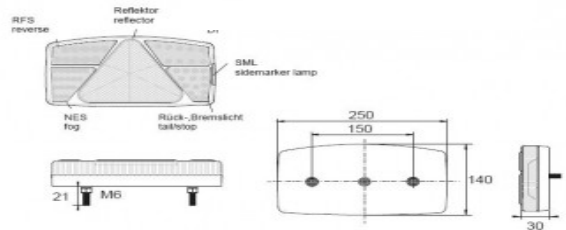

Referencia: Reference-No.	Ud. QTY	Izq. left	Dch. right	Luz Matrícula Numberplate- lamp	Descripción - Referencia O.E. Specification - O.E.-No.	Conector - Accesorios - Recambios Connector - Accessories - Spare Parts
A41-1310-011	1	■			Versión con cable 0.5m BALIZAMIENTO LATERAL LED version with 0.5m cable	
A41-1310-121	1		■		Versión con cable 0.5m BALIZAMIENTO LATERAL LED version with 0.5m cable	
FA41-1310-041	1	■			Versión con cable 0.5m version with 0.5m cable	
FA41-1310-151	1		■		Versión con cable 0.5m version with 0.5m cable	

Piloto Trasero LED





LED Rear Combination Lamp

Tipo: AGRIPPOINT LED 12/24V IP54

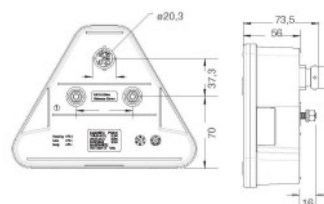
Función: Luz Posición LED - Freno LED - Intermitente LED -
Triángulo - Reflectante

Function: LED Tail Lamp - LED Stop Lamp - LED Dir. Indicator Lamp -
Triangle Reflex Reflector



Referencia: Reference-No.	Ud. QTY	Izq. left	Dch. right	Luz Matrícula Numberplate- lamp	Descripción - Referencia O.E. Specification - O.E.-No.	Conector - Accesorios - Recambios Connector - Accessories - Spare Parts
A23-4000-501	1	■	■		A23-4000-507 Versión con conector 5p version with connector 5 poles	
A23-4000-511	1		■	■ lateral/ lateral	A23-4000-517 Versión con conector 5p version with connector 5 poles	
A23-4000-521	1	■		■ lateral/ lateral	A23-4000-517 Versión con conector 5p version with connector 5 poles	
A23-4000-531	1	■	■	■ abajo/ below	A23-4000-537 Versión con conector 5p version with connector 5 poles	
A23-4000-001	1	■	■		A23-4000-007 Versión con cable 0.5m version with connector 5 poles	
A23-4000-011	1		■	■ lateral/ lateral	A23-4000-017 Versión con cable 0.5m version with connector 5 poles	
A23-4000-021	1	■		■ lateral/ lateral	A23-4000-027 Versión con cable 0.5m version with connector 5 poles	
A23-4000-031	1	■	■	■ abajo/ below	A23-4000-037 Versión con cable 0.5m version with connector 5 poles	

Piloto Trasero LED







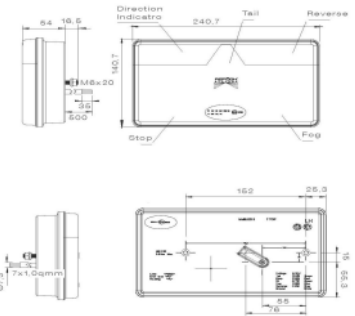
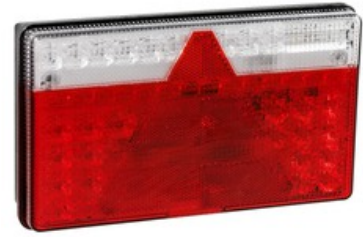

LED Rear Combination Lamp

Tipo: MULTILED II High 12/24V IP6K9K

Función: Luz Posición LED - Freno LED - Intermitente LED -
Marcha Atrás LED - Antiniebla LED - Triángulo
Reflectante

Function: LED Tail Lamp - LED Stop Lamp - LED Dir. Indicator Lamp -
LED Reversing Lamp - LED Fog Lamp - Triangle Reflex
Reflector



Referencia: Reference-No.	Ud. QTY	Izq. left	Dch. right	Luz Matrícula Numberplate- lamp	Descripción - Referencia O.E. Specification - O.E.-No.	Conector - Accesorios - Recambios Connector - Accessories - Spare Parts
A35-0203-051	1	■		■ lateral/ lateral	O.E.: A35-0203-057 Versión con cable 0.5m ver.cable 0.5m with open end	
A35-0204-051	1		■	■ lateral/ lateral	O.E.: A35-0204-057 Versión con cable 0.5m ver. cable 0.5m with open end	
A35-0203-061	1	■		■ lateral/ lateral	O.E.: A35-0203-067 Vers.cable 0.5m + baj. 5p. version cable 0.5m +5p bajonet, without reverse lamp	SIN MARCHA ATRÁS without reverse lamp 
A35-0204-061	1		■	■ lateral/ lateral	O.E.: A35-0204-067 Vers.cable 0.5m + baj. 5p. version cable 0.5m +5p bajonet, without reverse lamp	SIN MARCHA ATRÁS without reverse lamp 
A35-0203-071	1	■		■ lateral/ lateral	O.E.: A35-0203-077 Vers. cable 0.5m + baj. 8p. ver. cable 0.5m + 8p baj.,	
A35-0204-071	1		■	■ lateral/ lateral	A35-0204-077 Vers. cable 0.5m + baj. 8p. ver. cable 0.5m + 8p baj.	
A35-0203-121	1	■		■ abajo/ below	A35-0203-127 Vers. cable 0.5m + baj. 8p. ver. cable 0.5m + 8p baj.	
A35-0204-121	1	■		■ abajo/ below	A35-0204-127 Vers. cable 0.5m + baj. 8p. ver. cable 0.5m + 8p baj.	
A13-0546-004	1	■	■		Kit bayoneta 5p Repairkit 5p	
A15-0821-524	1	■	■		Kit bayoneta 8p Repairkit 5p	

Piloto Trasero LED

LED Rear Combination Lamp

Tipo: MULTILED II Flat 12/24V IP6K9K

Función: Luz Posición LED - Freno LED - Intermitente LED -
Marcha Atrás LED - Antiniebla LED - Triángulo
Reflectante

Function: LED Tail Lamp - LED Stop Lamp - LED Dir. Indicator Lamp -
LED Reversing Lamp - LED Fog Lamp - Triangle Reflex
Reflector

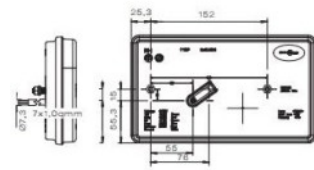
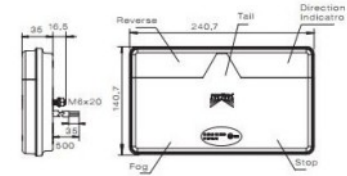
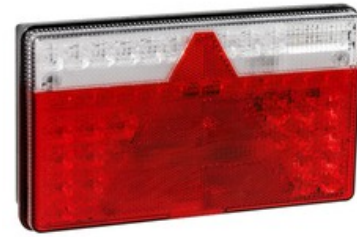

Referencia: Reference-No.	Ud. QTY	Izq. left	Dch. right	Luz Matrícula Numberplate- lamp	Descripción - Referencia O.E. Specification - O.E.-No.	Conector - Accesorios - Recambios Connector - Accessories - Spare Parts
A35-0203-031	1	■			O.E.: A35-0203-037 Versión con cable 0.5m + conector 7p ASS2 <i>version with cable 0.5m + 7poles ASS2 connector</i>	
A35-0202-031	1		■		A35-0202-037 Versión con cable 0.5m + conector 7p ASS2 <i>version with cable 0.5m + 7poles ASS2 connector</i>	
A35-0201-041	1	■			A35-0201-047 Versión con cable 0.5m + conector 7p AMP <i>version with connector 8poles</i>	
A35-0202-041	1		■		A35-0204-127 Versión con cable 0.5m + conector 7p AMP <i>version with connector 8poles</i>	
A13-5626-941	1	■			Conector amarillo, para las versiones Aspöck ASS1 & ASS2 <i>Connector yellow, for Aspöck ASS1 & ASS2 connector system</i>	
A13-5626-951	1		■		Conector verde, para las versiones Aspöck ASS1 & ASS2 <i>Connector green, for Aspöck ASS1 & ASS2 connector system</i>	
P50.071.100	1	■	■		Kit Conector AMP <i>Repairkit</i>	

Piloto Trasero LED

LED Rear Combination Lamp

Tipo: MULTILED 12/24V IP69K

Función: Luz Posición LED - Freno LED - Intermitente LED -
Marcha Atrás LED - Antiniebla LED - Triángulo
Reflectante

Function: LED Tail Lamp - LED Stop Lamp - LED Dir. Indicator Lamp -
LED Reversing Lamp - LED Fog Lamp - Triangle Reflex
Reflector

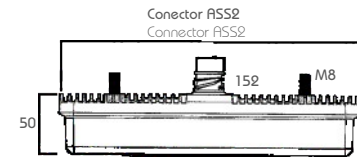
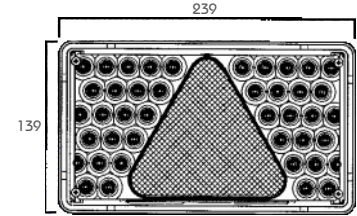

Referencia: Reference-No.	Ud. QTY	Izq. left	Dch. right	Luz Matrícula Numberplate- lamp	Descripción - Referencia O.E. Specification - O.E.-No.	Conector - Accesorios - Recambios Connector - Accessories - Spare Parts
A24-7400-701	1	■			O.E.: A24-7400-707 Versión conector ASS2.1 ver.7p ASS2.1 connector	Controlador LED LCG incluido
A24-7500-701	1		■		O.E.: A24-7500-707 Versión conector ASS2.1 ver.7p ASS2.1 connector	Controlador LED LCG incluido
A24-7430-701	1	■			O.E.: A24-7430-707 Versión 7p AMP + 2p ASS2 version 7p AMP + 2p ASS2 connector	Controlador LED LCG incluido
A24-7530-701	1		■		O.E.: A24-7530-707 Versión 7p AMP + 2p ASS2 version 7p AMP + 2p ASS2 connector	Controlador LED LCG incluido
A24-7470-701	1	■			O.E.: A24-7470-707 Versión 7p AMP + 2p ASS2 version 7p AMP + 2p ASS2 connector	SIN TRIANGULO Controlador LED LCG incluido
A24-7570-701	1		■		A24-7570-707 Versión 7p AMP + 2p ASS2 version 7p AMP + 2p ASS2 connector	SIN TRIANGULO Controlador LED LCG incluido
A24-7630-701	1	■			A24-7630-707 Versión 7p AMP + 2p ASS2 version 7p AMP + 2p ASS2 connector	Carcasa Plástico Controlador LED LCG incluido
A24-7730-701	1		■		A24-7730-707 Versión 7p AMP + 2p ASS2 version 7p AMP + 2p ASS2 connector	Carcasa Plástico Controlador LED LCG incluido
P50.071.100	1	■	■			
A13-5626-941	1	■				
A13-5626-951	1		■			

Piloto Trasero LED



LED Rear Combination Lamp

Tipo: EARPOINT LED 12/24V IP6K9K

Función: Luz Posición LED - Freno LED - Intermitente LED -
Marcha Atrás LED - Antiniebla LED - Triángulo
Reflectante

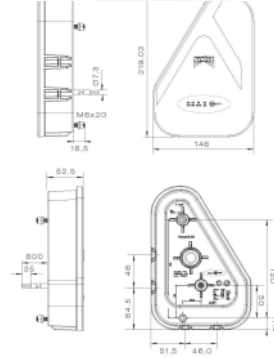
Function: LED Tail Lamp - LED Stop Lamp - LED Dir. Indicator Lamp -
LED Reversing Lamp - LED Fog Lamp - Triangle Reflex
Reflector



Referencia: Reference-No.	Ud. QTY	Izq. left	Dch. right	Luz Matrícula Numberplate- lamp	Descripción - Referencia O.E. Specification - O.E.-No.	Conector - Accesorios - Recambios Connector - Accessories - Spare Parts
A35-0301-001	1	■		■ lateral/ lateral	A35-0301-007 Versión con cable 0.8m Antiniebla version with cable 0.8m fog	
A35-0302-001	1		■	■ lateral/ lateral	A35-0302-007 Versión con cable 0.8m Marcha atrás version with cable 0.8m reverse	
A35-0301-011	1	■		■ abajo/ below	A35-0301-017 Versión con cable 0.8m y conector 5p. Antiniebla version with connector 5poles with fog	
A35-0302-011	1		■	■ abajo/ below	A35-0302-017 Versión con cable 0.8m y conector 5p. Marcha Atrás version with connector 5poles with reverse lamp	
A13-0546-004	1	■	■		Kit conector Repairkit	

NEW

Piloto trasero Híbrido

Hybrid Rear Combination Lamp

Tipo: 7 FUNCIONES

Función: Posición LED - Freno LED - Intermitente -
Marcha atrás - Antiniebla - Balizamiento LED
Luz de matrícula - Reflectante

Function: LED Tail Lamp - LED Stop Lamp - Dir. Indicator Lamp -
Reversing Lamp - Fog Lamp - LED end outline Marker
Numberplate Lamp - Reflex Reflector

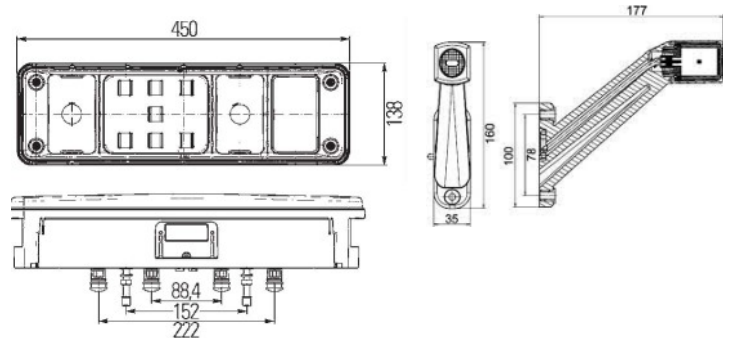

Referencia: Reference-No.	Ud. QTY	Izq. left	Dch. right	Luz Matrícula Numberplate- lamp	Descripción - Referencia O.E. Specification - O.E.-No.	Conector - Accesorios - Recambios Connector - Accessories - Spare Parts
P50.200.153 24V	1	■			<p>Carcasa: ABS+PC Tulipa: PMMA Conexión: Conector HCSCS 8p. Voltaje: 24 Volt Protección: IP5K4K, X9K Montaje: horizontal / vertical Homolog.: ECE EMV</p> <p>Intermitente: 24V-3W Posición: 24V-0,2W Freno: 24V-20W Antiniebla: 24V-2,5W Marcha atrás: 24V-2,5W Luz Matrícula: 24V-1,7W</p>	
P50.200.154 24V	1		■		<p>Housing: ABS+PC Lens: PMMA Cable: HCSCS 8p. Connector Voltage: 24 Volt Protection: IP5K4K, X9K Fixation: horizontal Homologation: ECE approved EMC approved</p> <p>Dir. Indicator: 24V-3W Tail: 24V-0,2W Stop: 24V-20W Fog: 24V-2,5W Reverse: 24V-2,5W Number Plate 24V-1.7W</p>	
P50.200.452 Tulipa	1	■	■		<p>Tulipa Lens</p>	

NEW

Piloto trasero Híbrido

Hybrid Rear Combination Lamp

Tipo: KRONE

Función: Posición LED - Freno LED - Intermitente -
Marcha atrás - Antiniebla - Balizamiento LED
Luz de matrícula - Reflectante

Function: LED Tail Lamp - LED Stop Lamp - Dir. Indicator Lamp -
Reversing Lamp - Fog Lamp - LED end outline Marker
Numberplate Lamp - Reflex Reflector

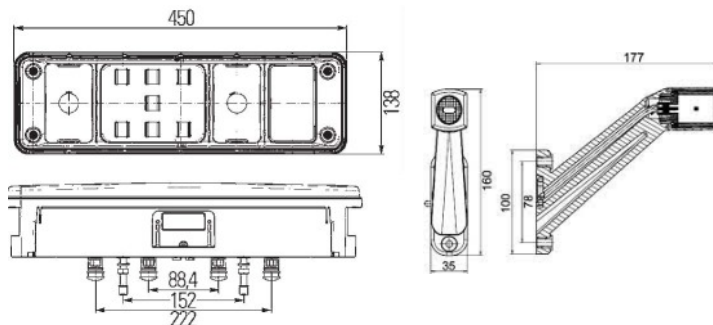

Referencia: Reference-No.	Ud. QTY	Izq. left	Dch. right	Luz Matrícula Numberplate- lamp	Descripción - Referencia O.E. Specification - O.E.-No.	Conector - Accesorios - Recambios Connector - Accessories - Spare Parts
P50.200.155 24V	1	■			<p>Carcasa: ABS+PC Tulipa: PMMA Conexión: Conector HCSCS 8p. Voltaje: 24 Volt Protección: IP5K4K, X9K Montaje: horizontal / vertical Homolog.: ECE EMV</p> <p>Intermitente: 24V-3W Posición: 24V-0,2W Freno: 24V-20W Antiniebla: 24V-2,5W Marcha atrás: 24V-2.5W Luz Matrícula: 24V-1,7W</p>	
P50.200.156 24V	1		■		<p>Housing: ABS+PC Lens: PMMA Cable: HCSCS 8p. Connector Voltage: 24 Volt Protection: IP5K4K, X9K Fixation: horizontal Homologation: ECE approved EMC approved</p> <p>Dir. Indicator: 24V-3W Tail: 24V-0,2W Stop: 24V-20W Fog: 24V-2,5W Reverse: 24V-2,5W Number Plate 24V-1.7W</p>	
P50.200.552 Tulipa	1	■			Tulipa Lens	
P50.200.553 Tulipa	1		■		Tulipa Lens	

Piloto Trasero

Rear Combination Lamp

Tipo: LC8 M.A.N.

Función: Luz Posición - Freno - Intermitente -
Marcha Atrás - Antiniebla - Luz Balizamiento
lateral - Reflectante

Function: Dir.Indicator-, Stop-, Rear-, Fog-, Reverse-, End Outline
Marker-, Numberplate-, Sidemarker Lamp red,
Reflex Reflector, Opt. Back Alarm System

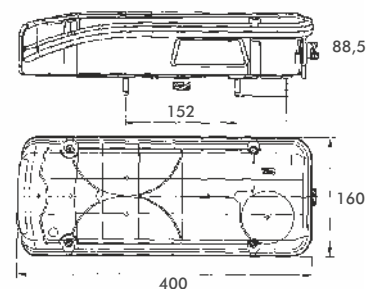

Referencia: Reference-No.	Ud. QTY	Izq. left	Dch. right	Luz Matrícula Numberplate- lamp	Descripción - Referencia O.E. Specification - O.E.-No.	Conector - Accesorios - Recambios Connector - Accessories - Spare Parts
S40.253.012	1		■		M.A.N. TG-A 81.25225.6545	
S40.253.013	1	■		■	M.A.N. TG-A 81.25225.6544	
P40.253.015	1		■		M.A.N. TG-A 81.25225.6547 Avisador acústico integrado Back Alarm System	
S40.253.111	1	■			M.A.N. TG-A 81.25229.6059 Tulipa Lens	
S40.253.112	1		■		M.A.N. TG-A 81.25229.6060 Tulipa Lens	
P50.071.100	1	■	■		Kit Bayoneta AMP Repairkit	
P50.120.000	2	■	■		Kit cableado 4m con conector AMP Cablekit with AMP connector, 4m	

Piloto Trasero

Rear Combination Lamp

Tipo: M.A.N. / RENAULT / DAF

Función: Luz Posición - Freno - Intermitente -
Marcha Atrás - Antiniebla - Luz Balizamiento
lateral - Reflectante - Opcional Módulo LED

*Function: Dir.Indicator-, Stop-, Rear-, Fog-, Reverse-, End Outline
Marker-, Numberplate-, Sidemarker Lamp,
Reflex Reflector, Opt. LED Module*

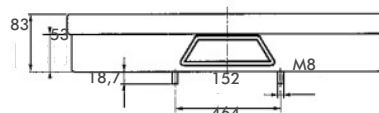
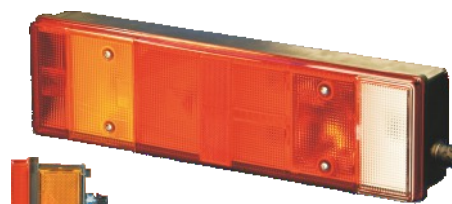

Referencia: Reference-No.	Ud. QTY	Izq. left	Dch. right	Luz Matrícula Numberplate- lamp	Descripción - Referencia O.E. Specification - O.E.-No.	Conector - Accesorios - Recambios Connector - Accessories - Spare Parts
P40.207.322/1	1		■		M.A.N. TG-A 81.25225.6523 RENAULT 5001847585	DAF 1625986 
P40.207.323/1	1	■		■	M.A.N. TG-A 81.25225.6524 RENAULT 5001847584	DAF 1625985 
P40.207.324/1	1		■	■		
P40.207.112/1	2	■	■		M.A.N. TG-A 81.25225.6524 RENAULT 5001847584 Tulipa Lens	
P50.062.001	1	■	■		Luz posición lateral <i>Insert Sidemarker Lamp</i>	
P40.199.002	10	■	■		Módulo LED Función: Posición/Gálibo <i>LED Unit Function Rear light/End Outline Marker</i>	glowpoint BA 15s 
P50.071.100	1	■	■		Kit Bayoneta AMP <i>Repairkit</i>	

Piloto Trasero

Rear Combination Lamp

Tipo: **M.A.N. / STEYR**

Función: Luz Posición - Freno - Intermitente -
Marcha Atrás - Antiniebla - Luz Balizamiento
lateral - Reflectante - Opcional Módulo LED

Function: Dir.Indicator, Stop, Rear, Fog, Reverse, End Outline
Marker, Numberplate, Sidemarker Lamp,
Reflex Reflector, Opt. LED Module

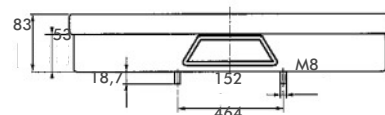

Referencia: Reference-No.	Ud. QTY	Izq. left	Dch. right	Luz Matrícula Numberplate- lamp	Descripción - Referencia O.E. Specification - O.E.-No.	Conector - Accesorios - Recambios Connector - Accessories - Spare Parts
P40.207.312/1	1		■		M.A.N. STEYR Piloto: 81.25228.6030 Piloto: 81.25225.6464 Tulipa: 81.25229.6051	
P40.207.313/1	1	■		■	M.A.N. STEYR Piloto: 81.25228.6029 Piloto: 81.25225.6465 Tulipa: 81.25229.6051	
P40.207.314/1	1		■	■		
P40.207.112/1	2	■	■		M.A.N.: 81.25229.6051 STEYR: 892.00.81.006 Tulipa Lens	
P50.062.001	1	■	■		Luz posición lateral Insert Sidemarker Lamp	
P40.199.002	10	■	■		Módulo LED Función: Posición/Gálibo LED Unit Function Rear light/End Outline Marker	glowpoint BA 15s
P50.071.000	1	■	■		Kit Bayoneta AMP Repairkit	

Piloto Trasero

Rear Combination Lamp

Tipo: M.A.N. / UNIVERSAL

Función: Luz Posición - Freno - Intermitente -
Marcha Atrás - Antiniebla - Luz Balizamiento
lateral - Reflectante - Opcional Módulo LED

Function: Dir.Indicator-, Stop-, Rear-, Fog-, Reverse-, End Outline
Marker-, Numberplate-, Sidemarker Lamp,
Reflex Reflector, Opt. LED Module

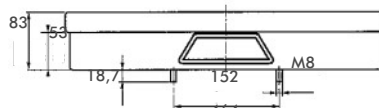
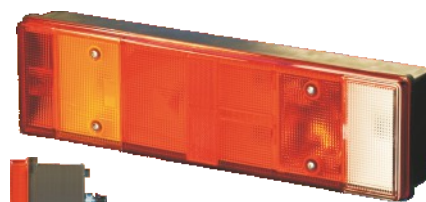

Referencia: Reference-No.	Ud. QTY	Izq. left	Dch. right	Luz Matrícula Numberplate- lamp	Descripción - Referencia O.E. Specification - O.E.-No.	Conector - Accesorios - Recambios Connector - Accessories - Spare Parts
P40.207.012/1	1	■	■			
P40.207.013/1	1	■		■		
P40.207.212/1	1	■	■		MAN 81.25288.6024	
P40.207.213/1	1	■		■	MAN 81.25228.6025	
P40.207.112/1	2	■	■		MAN 81.25229.6051 Tulipa Lens	
P40.199.002	10	■	■		Modulo LED Función: Posición/Gálbo LED Unit Function Rear light/End Outline Marker	glowpoint BA 15s
P50.125.000	1	■	■		Controlador LED LED Control Gear	
P50.071.000	1	■	■		Kit Bayoneta AMP Repairkit	

Piloto Trasero

Rear Combination Lamp

Tipo: LC8 DAF

Función: Luz Posición - Freno - Intermitente -
Marcha Atrás - Antiniebla - Luz Balizamiento
lateral - Reflectante - Opcional Retro-alarma

Function: Dir.Indicator-, Stop-, Rear-, Fog-, Reverse-, End Outline
Marker-, Numberplate-, Sidemarker Lamp red,
Reflex Reflector, Opt. Back Alarm System

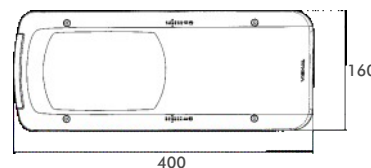
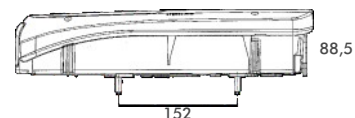

Referencia: Reference-No.	Ud. QTY	Izq. left	Dch. right	Luz Matrícula Numberplate- lamp	Descripción - Referencia O.E. Specification - O.E.-No.	Conector - Accesorios - Recambios Connector - Accessories - Spare Parts
P40.253.312	1		■		DAF 1875576	
P40.253.313	1	■		■	DAF 1875577	
P40.253.315	1		■		DAF 1875578 Retro-Alarma Integrada Back Alarm System	
P40.253.412	1		■		DAF 1875579	
P40.253.413	1	■		■	DAF 1875580	
P40.253.415	1		■		DAF 1875581 Retro-Alarma Integrada Back Alarm System	
P40.253.131	1	■			DAF 1914690 Tulipa Lens	
P40.253.132	1		■		DAF 1914691 Tulipa Lens	
P50.068.000	1	■	■		Kit Conector HDSCS Repairkit HDSCS	

Piloto Trasero





Rear Combination Lamp

Tipo: DAF

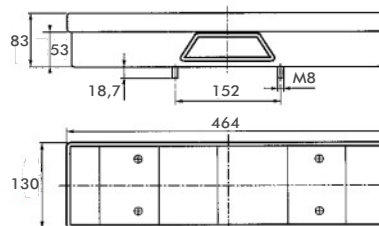
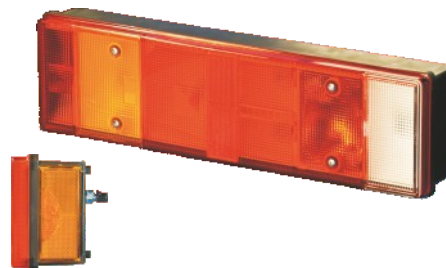
Función: Luz Posición - Freno - Intermitente -
 Marcha Atrás - Antiniebla - Luz Balizamiento
 lateral - Reflectante - Opcional Módulo LED

Function: Dir.Indicator-, Stop-, Rear-, Fog-, Reverse-, End Outline
 Marker-, Numberplate-, Sidemarkers Lamp,
 Reflex Reflector, Opt. LED Module



Referencia: Reference-No.	Ud. QTY	Izq. left	Dch. right	Luz Matrícula Numberplate- lamp	Descripción - Referencia O.E. Specification - O.E.-No.	Conector - Accesorios - Recambios Connector - Accessories - Spare Parts
P40.207.512/1	1	■	■		DAF 1284211	
P40.207.513/1	1	■		■	DAF 1284212	
P40.207.514/1	1		■	■		
P40.207.112/1	2	■	■		DAF 1272653 Tulipa Lens	
P50.062.001	1	■	■		Luz posición lateral Insert Sidemarkers Lamp	
P40.199.002	10	■	■		Módulo LED Función: Posición/Gálibo LED Unit Function Rear light/End Outline Marker	glowpoint  BA 15s

Piloto Trasero

Rear Combination Lamp

Tipo: LC8 IVECO

Función: Luz Posición - Freno - Intermitente -
 Marcha Atrás - Antiniebla - Luz Balizamiento
 lateral - Reflectante - Opcional Retro-alarma

Function: Dir.Indicator-, Stop-, Rear-, Fog-, Reverse-, End Outline
 Marker-, Numberplate-, Sidemarker Lamp red,
 Reflex Reflector, Opt. Back Alarm System

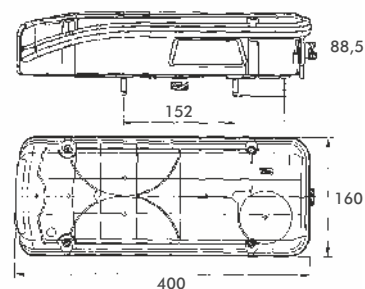

Referencia: Reference-No.	Ud. QTY	Izq. left	Dch. right	Luz Matrícula Numberplate- lamp	Descripción - Referencia O.E. Specification - O.E.-No.	Conector - Accesorios - Recambios Connector - Accessories - Spare Parts
P40.253.612	1		■		IVECO 5801637201	
P40.253.613	1	■		■	IVECO 5801637199	
P40.253.615	1		■		IVECO 5801637202 Retro-Alarma Integrada Back Alarm System	
P40.253.811	1	■			IVECO 5801637182	
P40.253.812	1		■		IVECO 5801757328	
P40.253.813	1	■		■	IVECO 5802055272 Retro-Alarma Integrada Back Alarm System	
P40.253.815	1		■		IVECO 5801757326	
P40.253.141	1	■			Tulipa Lens	
P40.253.142	1		■		Tulipa Lens	
P50.068.000	1	■	■		Kit Conector HDSCS Repairkit HDSCS	

Piloto Trasero

Rear Combination Lamp

Tipo: IVECO

Función: Luz Posición - Freno - Intermitente -
 Marcha Atrás - Antiniebla - Luz Balizamiento
 lateral - Reflectante - Opcional Módulo LED

Function: Dir.Indicator-, Stop-, Rear-, Fog-, Reverse-, End Outline
 Marker-, Numberplate-, Sidemarker Lamp,
 Reflex Reflector, Opt. LED Module

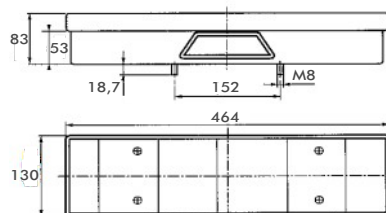
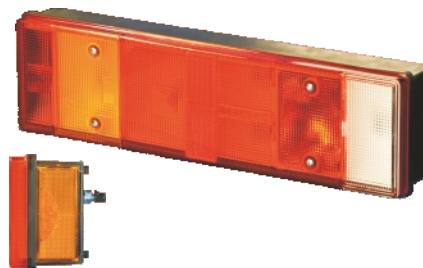

Referencia: Reference-No.	Ud. QTY	Izq. left	Dch. right	Luz Matrícula Numberplate- lamp	Descripción - Referencia O.E. Specification - O.E.-No.	Conector - Accesorios - Recambios Connector - Accessories - Spare Parts
P40.207.811/1	1	■			IVECO 99 46 32 43	
P40.207.812/1	1		■		IVECO 99 46 32 42	
P40.207.813/1	1	■		■	IVECO 99 46 32 44	
P40.207.814/1	1		■	■		
P40.207.112/1	2	■	■		IVECO:99 46 18 44 Tulipa Lens	
P50.062.001	1	■	■		Luz posición lateral Insert Sidemarker Lamp	
P40.199.002	10	■	■		Módulo LED, Función: Posición/Gálbo LED Unit, Function Rear light/End Outline Marker	glowpoint  BA 15s

Piloto Trasero





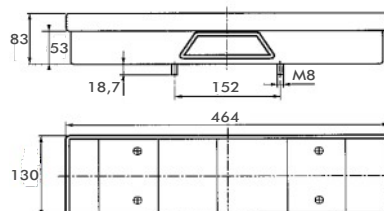
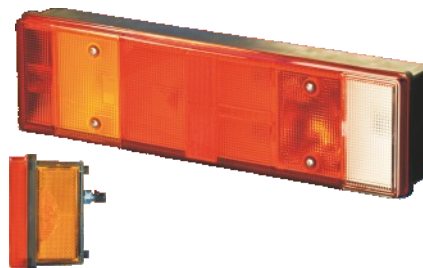

Rear Combination Lamp

Tipo: IVECO

Función: Luz Posición - Freno - Intermitente -
Marcha Atrás - Antiniebla - Luz Balizamiento
lateral - Reflectante - Opcional Módulo LED

Function: Dir.Indicator-, Stop-, Rear-, Fog-, Reverse-, End Outline
Marker-, Numberplate-, Sidemarker Lamp,
Reflex Reflector, Opt. LED Module



Referencia: Reference-No.	Ud. QTY	Izq. left	Dch. right	Luz Matrícula Numberplate- lamp	Descripción - Referencia O.E. Specification - O.E.-No.	Conector - Accesorios - Recambios Connector - Accessories - Spare Parts
P40.207.811/2	1	■				
P40.207.812/2	1		■			
P40.207.813/2	1	■		■		
P40.207.814/2	1		■	■		
P40.207.112/1	2	■	■		IVECO:99 46 18 44 Tulipa Lens	
P50.062.001	1	■	■		Luz posición lateral Insert Sidemarker Lamp	
P40.199.002	10	■	■		Módulo LED, Función: Posición/Gálibo LED Unit, Function Rear light/End Outline Marker	glowpoint  BA 15s

Piloto Trasero

Rear Combination Lamp

Tipo: UNIVERSAL

Función: Luz Posición - Freno - Intermitente -
Marcha Atrás - Antiniebla - Luz Balizamiento
lateral - Reflectante - Opcional Módulo LED

Function: Dir.Indicator-, Stop-, Rear-, Fog-, Reverse-, End Outline
Marker-, Numberplate-, Sidemarkers Lamp,
Reflex Reflector, Opt. LED Module

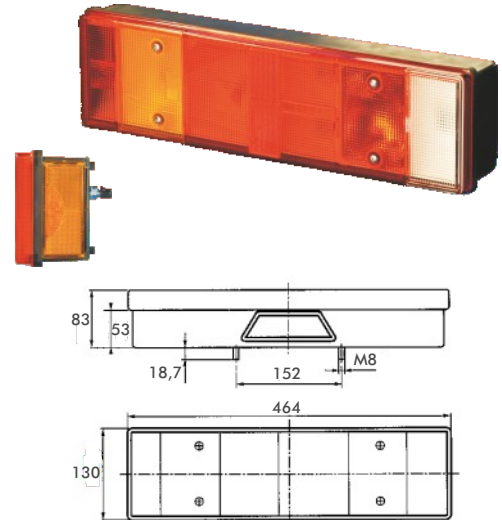

Referencia: Reference-No.	Ud. QTY	Izq. left	Dch. right	Luz Matrícula Numberplate- lamp	Descripción - Referencia O.E. Specification - O.E.-No.	Conector - Accesorios - Recambios Connector - Accessories - Spare Parts
P40.207.612/1	1	■	■		Con Reflectante with Reflex Reflector	
P40.207.613/1	1	■		■	Con Reflectante with Reflex Reflector	
P40.207.614/1	1		■	■	Con Reflectante with Reflex Reflector	
P40.207.112/1	2	■	■		Tulipa Lens	
P50.062.001	1	■	■		Luz posición lateral Insert Sidemarkers Lamp	
P40.199.002	10	■	■		Módulo LED, Función: Posición/Gálbo LED Unit Function Rear light/End Outline Marker	glowpoint BA 15s
P50.125.000	1	■	■		Controlador LED LED Control Gear	

Piloto Trasero



Rear Combination Lamp

Tipo: RENAULT / FRUEHAUF / M.A.N.

Función: Luz Posición - Freno - Intermitente -
Marcha Atrás - Antiniebla - Luz Matrícula - Reflectante

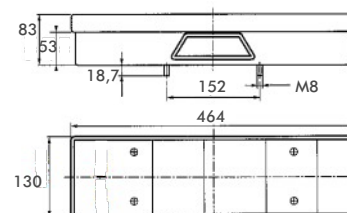
Function: Dir.Indicator-, Stop-, Rear-, Fog-, Reverse Lamp,
Reflex Reflector, Opt. LED Module



Referencia: Reference-No.	Ud. QTY	Izq. left	Dch. right	Luz Matrícula Numberplate- lamp	Descripción - Referencia O.E. Specification - O.E.-No.	Conector - Accesorios - Recambios Connector - Accessories - Spare Parts
P40.208.012	1	■	■		MB ACTROS 001 540 6270 Con Reflectante with Reflex Reflector	
P40.208.102	2	■	■		Tulipa sin Reflectante Lens without Reflex Reflector	
P40.208.112	2	■	■		Tulipa con Reflectante Lens with Reflex Reflector	
P40.199.002	10	■	■		Módulo LED Posición/Gálbo LED Unit Function Rear light/End Outline Marker	glowpoint BA 15s 

Piloto Trasero

Rear Combination Lamp

Tipo: LC8 SCANIA Serie P&R

Función: Luz Posición - Freno - Intermitente -
 Marcha Atrás - Antiniebla - Luz Balizamiento
 lateral - Reflectante - Opcional Avisador Acústico

Function: Dir.Indicator-, Stop-, Rear-, Fog-, Reverse-, End Outline
 Marker-, Numberplate-, Sidemarker Lamp red,
 Reflex Reflector, Opt. Back Alarm System

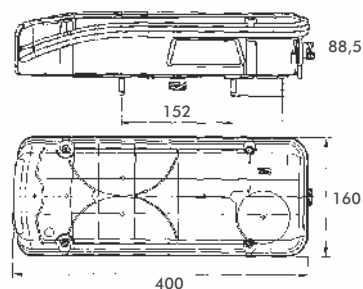

Referencia: Reference-No.	Ud. QTY	Izq. left	Dch. right	Luz Matrícula Numberplate- lamp	Descripción - Referencia O.E. Specification - O.E.-No.	Conector - Accesorios - Recambios Connector - Accessories - Spare Parts
S40.253.712	1		■		SCANIA 1756751	
S40.253.713	1	■		■	SCANIA 1756754	
P40.253.715	1		■		SCANIA 1791369 Avisador acústico integrado Back Alarm System	
P40.253.151	1	■			SCANIA 1784669 Tulipa Lens	
S40.253.152	1		■		SCANIA 1784670 Tulipa Lens	
P50.071.100	1	■	■		Kit Bayoneta AMP Repairkit	
P50.120.000	2	■	■		Kit cableado 4m con conector AMP Cablekit with AMP connector, 4m	

Piloto Trasero





Rear Combination Lamp

Tipo: SCANIA

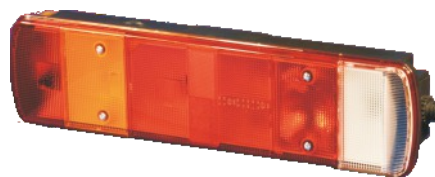
Función: Luz Posición - Freno - Intermitente -
 Marcha Atrás - Antiniebla - Luz Balizamiento
 lateral - Reflectante - Opcional Módulo LED

Function: Dir.Indicator-, Stop-, Rear-, Fog-, Reverse-, End Outline
 Marker-, Numberplate-, Sidemarket Lamp,
 Reflex Reflector, Opt. LED Module



Referencia: Reference-No.	Ud. QTY	Izq. left	Dch. right	Luz Matrícula Numberplate- lamp	Descripción - Referencia O.E. Specification - O.E.-No.	Conector - Accesorios - Recambios Connector - Accessories - Spare Parts
P40.223.312/1	1	■	■		SCANIA 1498103	
P40.223.313/1	1	■		■	SCANIA 1498102	
P40.223.314/1	1		■	■	SCANIA 1545607	
P40.223.112/1	1	■	■		SCANIA 1380819 Tulipa Lens	
P40.199.002	10	■	■		Módulo LED Función: Posición/Gálibo LED Unit Function Rear light/End Outline Marker	glowpoint  BA 15s
P50.071.100	1	■	■		Kit Bayoneta AMP Repairkit	

Piloto Trasero

Rear Combination Lamp

Tipo: SCANIA SERIE R

Función: Luz Posición - Freno - Intermitente -
Marcha Atrás - Antiniebla - Luz Balizamiento
lateral - Reflectante - Opcional Módulo LED

Function: Dir.Indicator-, Stop-, Rear-, Fog-, Reverse-, End Outline
Marker-, Numberplate-, Sidemarket Lamp,
Reflex Reflector, Opt. LED Module

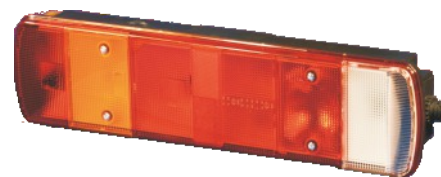

Referencia: Reference-No.	Ud. QTY	Izq. left	Dch. right	Luz Matrícula Numberplate- lamp	Descripción - Referencia O.E. Specification - O.E.-No.	Conector - Accesorios - Recambios Connector - Accessories - Spare Parts
P40.223.312/2	1	■	■		SCANIA 1792374	
P40.223.313/2	1	■		■	SCANIA 1792375	
P40.223.314/2	1		■	■		
P40.223.112/1	1	■	■		SCANIA 1380819 Tulipa Lens	
P40.199.002	10	■	■		Módulo LED Función: Posición/Gálido LED Unit Function Rear light/End Outline Marker	glowpoint BA 15s
P50.071.100	1	■	■		Kit Bayoneta AMP Repairkit	

Piloto Trasero

Rear Combination Lamp

Tipo: SCANIA

Función: Luz Posición - Freno - Intermitente -
Marcha Atrás - Antiniebla - Luz Balizamiento
lateral - Reflectante - Opcional Módulo LED

Function: Dir.Indicator-, Stop-, Rear-, Fog-, Reverse-, End Outline
Marker-, Numberplate-, Sidemarket Lamp,
Reflex Reflector, Opt. LED Module



Referencia: Reference-No.	Ud. QTY	Izq. left	Dch. right	Luz Matrícula Numberplate- lamp	Descripción - Referencia O.E. Specification - O.E.-No.	Conector - Accesorios - Recambios Connector - Accessories - Spare Parts
P40.223.012/1	1		■		SCANIA 1380446/1397496/1436849 1436866/1504601/1504603	
P40.223.013/1	1	■		■	SCANIA 1371974/1371976/1387877 1436851/1436854/1436867 1504605/1504608/1508178	
P40.223.014/1	1		■	■		
P40.223.112/1	1	■	■		SCANIA 1380819 Tulipa Lens	
P40.199.002	10	■	■		Módulo LED Función: Posición/Gálbo LED Unit Function Rear light/End Outline Marker	glowpoint BA 15s

Piloto Trasero



Rear Combination Lamp

Tipo: VOLVO

Función: Luz Posición - Freno - Intermitente -
 Marcha Atrás - Antiniebla - Luz Balizamiento
 lateral - Reflectante - Opcional Módulo LED

Function: Dir.Indicator-, Stop-, Rear-, Fog-, Reverse-, End Outline
 Marker-, Numberplate-, Sidemarket Lamp,
 Reflex Reflector, Opt. LED Module



Referencia: Reference-No.	Ud. QTY	Izq. left	Dch. right	Luz Matrícula Numberplate- lamp	Descripción - Referencia O.E. Specification - O.E.-No.	Conector - Accesorios - Recambios Connector - Accessories - Spare Parts
P40.223.212	1	■	■		VOLVO 08/98 3981456/3981459/3981461 3981463	
P40.223.213	1	■		■	VOLVO 08/98 3981455/3981460	
P40.223.214	1		■	■		
P40.223.112/1	1	■	■		VOLVO 08/98 3981782 Tulipa Lens	
P40.199.002	10	■	■		Módulo LED Función: Posición/Gálbo LED Unit Function Rear light/End Outline Marker	glowpoint  BA 15s
P50.071.100	1	■	■		Kit Conector AMP Repairkit	

Piloto Trasero

Rear Combination Lamp

Tipo: LC9 VOLVO / RENAULT

Función: Luz Posición - Freno - Intermitente -
 Marcha Atrás - Antiniebla - Luz Balizamiento
 lateral - Reflectante - Opcional Retro-alarma

Function: Dir.Indicator-, Stop-, Rear-, Fog-, Reverse-, End Outline
 Marker-, Numberplate-, Sidemarket Lamp red,
 Reflex Reflector, Opt. Back Alarm System

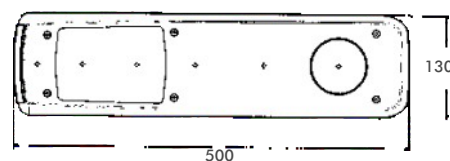
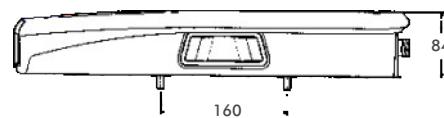

Referencia: Reference-No.	Ud. QTY	Izq. left	Dch. right	Luz Matrícula Numberplate- lamp	Descripción - Referencia O.E. Specification - O.E.-No.	Conector - Accesorios - Recambios Connector - Accessories - Spare Parts
S40.259.012	1		■		RENAULT 7420802350 Magnum,Premium,Kerax VOLVO 20802350 FE Serie >2006	
S40.259.013	1	■		■	RENAULT 7420802348 Magnum,Premium,Kerax VOLVO 20802346 FE Serie >2006	
S40.259.015	1		■		RENAULT 7420802353 Magnum,Premium,Kerax VOLVO 20802353 FE Serie >2006 Retro-alarma integrada Back Alarm System	
S40.259.112	1	■	■		RENAULT 7420802418 Magnum,Premium,Kerax VOLVO 20802418 FE Serie >2006 Tulipa Lens	
P50.071.100	1	■	■		Kit Conector AMP Repairkit	
P50.120.000	2	■	■		Kit conector AMP con 4m de Cable Cablekit with AMP connector, 4m	

Piloto Trasero

Rear Combination Lamp

Tipo: VOLVO

Función: Luz Posición - Freno - Intermitente -
Marcha Atrás - Antiniebla - Luz Balizamiento
lateral - Reflectante

Function: Dir.Indicator-, Stop-, Rear-, Fog-, Reverse-, End Outline
Marker-, Numberplate-, Sidemarker Lamp,
Reflex Reflector

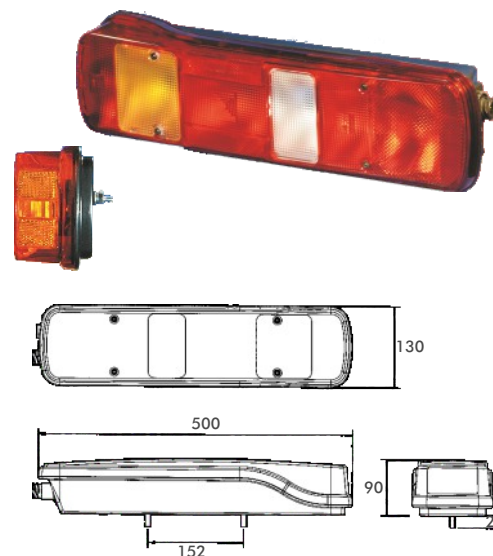

Referencia: Reference-No.	Ud. QTY	Izq. left	Dch. right	Luz Matrícula Numberplate- lamp	Descripción - Referencia O.E. Specification - O.E.-No.	Conector - Accesorios - Recambios Connector - Accessories - Spare Parts
P40.257.011/1	1	■			VOLVO 20565105	
P40.257.012/1	1		■		VOLVO 20565106	
P40.257.013/1	1	■		■	VOLVO 20565103	
P40.257.112/1	1	■	■		VOLVO 20565107 Tulipa Lens	
P50.071.100	1	■	■		Kit Conector AMP Repairkit	

Piloto Trasero



Rear Combination Lamp

Tipo: VOLVO

Función: Luz Posición - Freno - Intermitente -
Marcha Atrás - Antiniebla - Luz Balizamiento
lateral - Reflectante

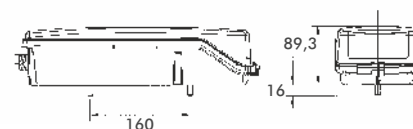
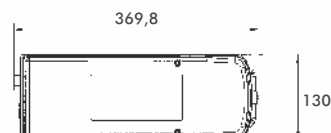
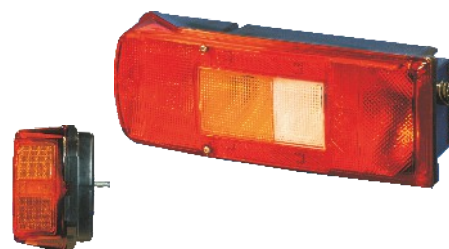
Function: Dir.Indicator-, Stop-, Rear-, Fog-, Reverse-, End Outline
Marker-, Numberplate-, Sidemarkers Lamp,
Reflex Reflector



Referencia: Reference-No.	Ud. QTY	Izq. left	Dch. right	Luz Matrícula Numberplate- lamp	Descripción - Referencia O.E. Specification - O.E.-No.	Conector - Accesorios - Recambios Connector - Accessories - Spare Parts
P40.251.012/1	1		■		VOLVO 20507624/20425729	
P40.251.013/1	1	■		■	VOLVO 20507623/20425728	
P40.251.112/1	1	■	■		VOLVO 20425732 Tulipa Lens	
P50.071.100	1	■	■		Kit Conector AMP Repairkit	

Piloto Trasero

Rear Combination Lamp

Tipo: MERCEDES BENZ ACTROS MP4

Función: Luz Posición - Freno - Intermitente -
Marcha Atrás - Antiniebla - Reflectante

Function: Dir.Indicator, Stop, Rear, Fog, Reverse, End Outline
Marker, Numberplate, Reflex Reflector,

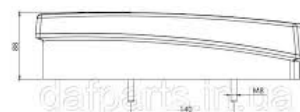
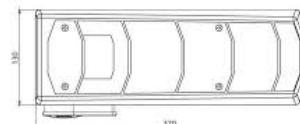

dataparts.int.ua



Referencia: Reference-No.	Ud. QTY	Izq. left	Dch. right	Luz Matrícula Numberplate- lamp	Descripción - Referencia O.E. Specification - O.E.-No.	Conector - Accesorios - Recambios Connector - Accessories - Spare Parts
P50.200.041	1	■		■	MB ACTROS 0035440903	
P50.200.042	1		■		MB ACTROS 0035440803	
P50.200.045	1		■		RETRO-ALARMA INTEGRADA A0035441003	
S50.200.142	1	■	■		Tulipa A0025447390 Lens A0025447390	

Piloto Trasero

Rear Combination Lamp

Tipo: LC8 MB SPRINTER / VW CRAFTER

Función: Luz Posición - Freno - Intermitente -
Marcha Atrás - Antiniebla - Luz Balizamiento
lateral - Reflectante

Function: Dir.Indicator, Stop-, Rear-, Fog-, Reverse-, End Outline
Marker-, Numberplate-, Sidemarker Lamp red,
Reflex Reflector

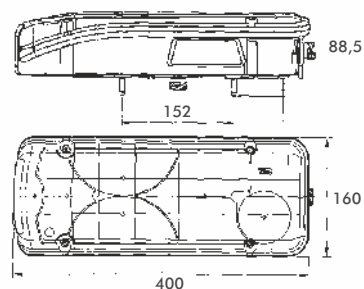

Referencia: Reference-No.	Ud. QTY	Izq. left	Dch. right	Luz Matrícula Numberplate- lamp	Descripción - Referencia O.E. Specification - O.E.-No.	Conector - Accesorios - Recambios Connector - Accessories - Spare Parts
P40.253.512	1		■		MB A906 820 1764ET VW 2E0 945 096 A	
P40.253.513	1	■		■	MB A906 820 0464ET VW 2E0 945 095 A	
S40.253.151	1	■			MB A000 826 2056 VW 2E0 945 111 Tulipa Lens	
S40.253.152	1		■		MB A006 826 2156 VW 2E0 945 112 Tulipa Lens	
P50.071.100	1	■	■		Kit Conector AMP Repairkit	
P50.120.000	2	■	■		Kit Conector AMP con 4m de Cable Cablekit with AMP connector, 4m	

Piloto Trasero

Rear Combination Lamp

Tipo: MERCEDES BENZ ACTROS

Función: Luz Posición - Freno - Intermitente -
Marcha Atrás - Antiniebla - Luz Balizamiento
lateral - Reflectante - Opcional Módulo LED

Function: Dir.Indicator, Stop, Rear, Fog, Reverse, End Outline
Marker, Numberplate, Sidemarker Lamp,
Reflex Reflector, Opt. LED Module

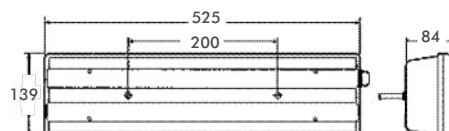

Referencia: Reference-No.	Ud. QTY	Izq. left	Dch. right	Luz Matrícula Numberplate- lamp	Descripción - Referencia O.E. Specification - O.E.-No.	Conector - Accesorios - Recambios Connector - Accessories - Spare Parts
P40.220.212/1	1		■		MB ACTROS 001 540 6370	
P40.220.213/1	1	■		■	MB ACTROS 001 540 6270	
P40.220.214/1	1		■	■		
P40.219.111/1	1	■			Tulipa Lens	
P40.219.112/1	1		■		Tulipa Lens	
P50.062.001	1	■	■		Balizamiento Lateral Insert Sidemarker Lamp	
P40.199.002	10	■	■		Módulo LED Función: Posición/Gálibo LED Unit Function Rear light/End Outline Marker	glowpoint BA 15s
P50.071.100	1	■	■		Kit Conector AMP Repairkit	

Piloto Trasero

Rear Combination Lamp

Tipo: MERCEDES BENZ SK

Función: Luz Posición - Freno - Intermitente -
Marcha Atrás - Antiniebla - Luz Balizamiento
lateral - Reflectante

*Function: Dir.Indicator, Stop-, Rear-, Fog-, Reverse-, End Outline
Marker-, Numberplate-, Sidemarker Lamp,
Reflex Reflector, Opt. LED Module*

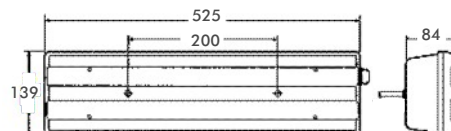

Referencia: Reference-No.	Ud. QTY	Izq. left	Dch. right	Luz Matrícula Numberplate- lamp	Descripción - Referencia O.E. Specification - O.E.-No.	Conector - Accesorios - Recambios Connector - Accessories - Spare Parts
P40.220.012/1			■		MB ACTROS 001 540 1870 Cable 1,2m con conector Cable 1,2m with connector	
P40.220.013/1	1	■		■	MB ACTROS 001 540 1770 Cable 1,2m con conector Cable 1,2m with connector	
P40.219.111/1	1	■			MB ACTROS 002 544 1290 Tulipa Lens	
P40.219.112/1	1		■		MB ACTROS 002 544 1390 Tulipa Lens	
P50.062.001	1	■	■		Balizamiento Lateral Insert Sidemarker Lamp	
P40.199.002	10	■	■		Módulo LEDI Función: Posición/Gálibo LED Unit Function Rear light/End Outline Marker	glowpoint BA 15s

Piloto Trasero

Rear Combination Lamp

**Tipo: MERCEDES BENZ
SPRINTER / ATEGO**

Función: Luz Posición - Freno - Intermitente -
Marcha Atrás - Antiniebla - Luz Balizamiento
lateral - Reflectante - Opcional Módulo LED

*Function: Dir.Indicator, Stop-, Rear-, Fog-, Reverse-, End Outline
Marker-, Numberplate Lamp, Reflex Reflector,
Opt. LED Module*

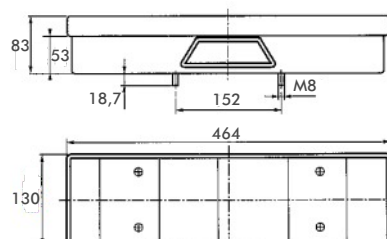

Referencia: Reference-No.	Ud. QTY	Izq. left	Dch. right	Luz Matrícula Numberplate- lamp	Descripción - Referencia O.E. Specification - O.E.-No.	Conector - Accesorios - Recambios Connector - Accessories - Spare Parts
P40.228.012/1	1	■	■		MB SPRINTER A 002 544 5403	
P40.228.013/1	1	■		■	MB SPRINTER A 002 544 5503	
P40.230.212/1	1	■	■		MB ATEGO A 002 544 5403/-5703	
P40.230.213/1	1	■		■	MB ATEGO A 002 544 5503/-5603	
P40.228.112/1	1	■	■		MB A 003 544 4790 Tulipa Lens	
P40.199.002	10	■	■		Módulo LED Función: Posición/Gálbo LED Unit Function Rear light/End Outline Marker	glowpoint BA 15s
P50.071.000	1	■	■		Kit Conector AMP Repairkit	

Piloto Trasero

Rear Combination Lamp

Tipo: MERCEDES BENZ ATEGO
con tapa posterior / with Tailboard

Función: Luz Posición - Freno - Intermitente -
Marcha Atrás - Antiniebla - Luz Balizamiento
lateral - Reflectante

Function: Dir.Indicator-, Stop-, Rear-, Fog-, Reverse-,
Numberplate Lamp, Reflex Reflector

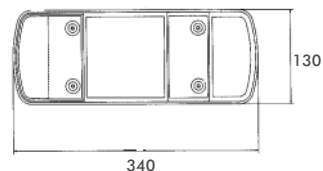

Referencia: Reference-No.	Ud. QTY	Izq. left	Dch. right	Luz Matrícula Numberplate- lamp	Descripción - Referencia O.E. Specification - O.E.-No.	Conector - Accesorios - Recambios Connector - Accessories - Spare Parts
P40.231.212	1	■	■		MB 002 544 6903 / 7103	
P40.231.213	1	■			MB 002 544 6803 / 7003	
P40.231.112	2	■	■		MB 002 544 6190 Tulipa Lens	
P50.071.000	1	■	■		Kit Conector AMP Repairkit	

Piloto Trasero

Rear Combination Lamp



Tipo: KÖGEL / SCHMITZ

Función: Luz Posición - Freno - Intermitente -
Marcha Atrás - Antiniebla - Luz Balizamiento
lateral

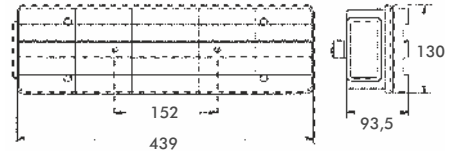

Function: Dir.Indicator-, Stop-, Rear-, Fog-, Reverse-,
Sidemarker Lamp

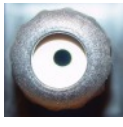

Referencia: Reference-No.	Ud. QTY	Izq. left	Dch. right	Luz Matrícula Numberplate- lamp	Descripción - Referencia O.E. Specification - O.E.-No.	Conector - Accesorios - Recambios Connector - Accessories - Spare Parts
P40.217.002	1	■	■		Kögel 324 944 Schmitz 062 345 / 062 423 Conector 6p Connector 6-poles	
P40.217.202	1	■	■		Kögel 333 423 Cable 1,44m + Conector 6p Cable 1,44m + connector 6-poles	
P40.217.302	1	■	■		Pasa-Cables PG-Screw	
FA40.217.102	1	■	■		Kögel 324 945 Schmitz 062 447 Tulipa Lens	

Piloto Trasero



Rear Combination Lamp

Tipo: MERCEDES BENZ / KRONE / SCHMITZ

Función: Luz Posición - Freno - Intermitente -
Marcha Atrás - Antiniebla - Luz Balizamiento
lateral - Reflectante

Function: Dir.Indicator-, Stop-, Rear-, Fog-, Reverse-,
Numberplate Lamp, Reflex Reflector



Referencia: Reference-No.	Ud. QTY	Izg. left	Dch. right	Luz Matrícula Numberplate- lamp	Anti- Niebla Fog- lamp	Marcha Atrás Reversing lamp	Descripción Referencia O.E. Specification - O.E.-No.	Conector - Accesorios Connector - Spare Parts
P40.218.011	1	■			■		MERCEDES BENZ 208 D - 410 > 03/89 507 D - 814 D > 01/86	
P40.218.012	1		■			■	MERCEDES BENZ 208 D - 410 > 03/89 507 D - 814 D > 01/86	
P40.218.013	1	■		■	■		MERCEDES BENZ 208 D - 410 > 03/89 507 D - 814 D > 01/86	
P40.218.111	2	■	■		■		MERCEDES BENZ 208 D - 410 > 03/89 507 D - 814 D > 01/86 Tulipa Lens	
P40.218.112	2	■	■			■	MERCEDES BENZ 208 D - 410 > 03/89 507 D - 814 D > 01/86 Tulipa Lens	

Piloto Trasero

Rear Combination Lamp

Tipo: LC5 UNIVERSAL / RENAULT
NISSAN / DAF

Función: Luz Posición - Freno - Intermitente -
Marcha Atrás - Antiniebla - Luz Matrícula - Reflectante

Function: Dir.Indicator-, Stop-, Rear-, Fog-, Reverse-,
Numberplate Lamp, Reflex Reflector

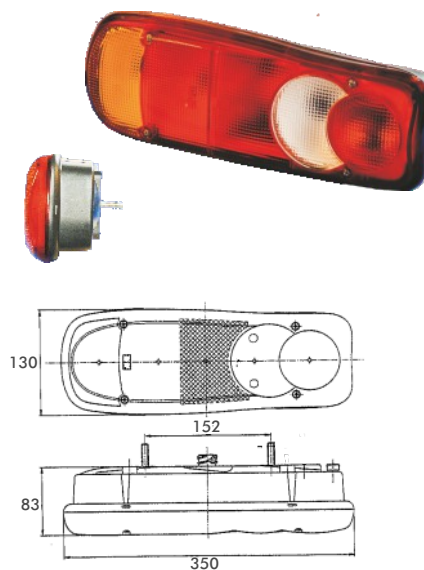

Referencia: Reference-No.	Ud. QTY	Izq. left	Dch. right	Luz Matrícula Numberplate- lamp	Descripción - Referencia O.E. Specification - O.E.-No.	Conector - Accesorios - Recambios Connector - Accessories - Spare Parts	
P1820/1	1	■	■				
P1830/1	1		■		RENAULT 5001846848 5001846849	DAF 1401713 NISSAN	
P1840/1	1	■		■	RENAULT 5001846847 5001846850	DAF 1401713 NISSAN	
40 243 102	2	■	■		Tulipa sin Reflectante Lens without Reflex Reflector		
P1850/1	2	■	■		RENAULT 5001847153	DAF 1451482 NISSAN	
P50.071.100	1	■	■		Kit Conector AMP Repairkit		

Piloto Trasero





Rear Combination Lamp

Tipo: MITSUBISHI

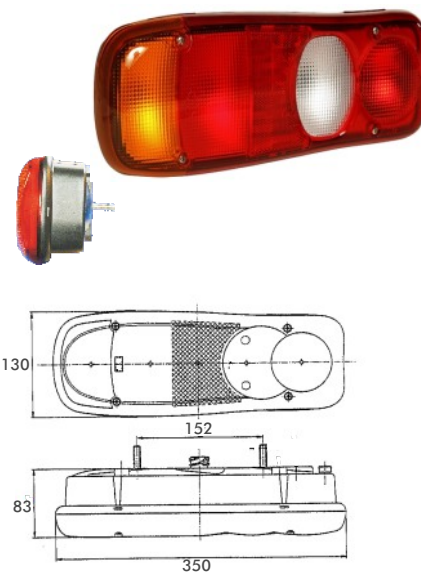
Función: Luz Posición - Freno - Intermitente -
Marcha Atrás - Antiniebla - Luz Matrícula - Reflectante

Function: Dir.Indicator-, Stop-, Rear-, Fog-, Reverse-,
Numberplate Lamp, Reflex Reflector



Referencia: Reference-No.	Ud. QTY	Izq. left	Dch. right	Luz Matrícula Numberplate- lamp	Descripción - Referencia O.E. Specification - O.E.-No.	Conector - Accesorios - Recambios Connector - Accessories - Spare Parts
P1860/1	1	■	■			
P1870/1	1		■			
P1890/1	1	■	■		Tulipa con Reflectante Lens without Reflex Reflector	
P50.071.100	1	■	■		Kit Conector AMP Repairkit	

Piloto Trasero



Rear Combination Lamp

Tipo: RENAULT / DAF / FRUEHAUF

Función: Luz Posición - Freno - Intermitente -
Marcha Atrás - Antiniebla - Luz Matrícula

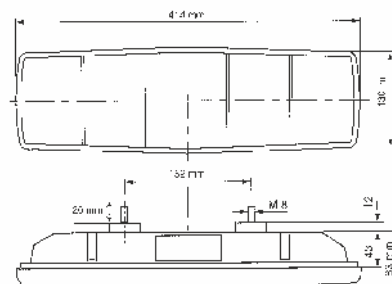
Function: Dir.Indicator-, Stop-, Rear-, Fog-, Reverse-,
Numberplate Lamp



Referencia: Reference-No.	Ud. QTY	Izq. left	Dch. right	Luz Matrícula Numberplate- lamp	Descripción - Referencia O.E. Specification - O.E.-No.	Conector - Accesorios - Recambios Connector - Accessories - Spare Parts
P40.209.003	1	■	■	■ Con Tapa with cover	DAF 0292052 FRUEHAUF LFA2668-701 Sin Reflectante without Reflex Reflector	
P40.209.013	1	■	■	■ Con Tapa with cover	DAF 0292052 RENAULT 5000808172 Con Reflectante with Reflex Reflector	
P40.209.103/1	1	■	■		DAF 0689052 RENAULT 5000807304 Tulipa sin Reflectante Lens without Reflex Reflector	
P40.209.113/1	1	■	■		DAF 069860 RENAULT 5000808166 Tulipa con Reflectante Lens with Reflex Reflector	

Piloto Trasero

Rear Combination Lamp



Tipo: 3-Funciones

Función: Intermitente-, Frenos-, Posición-, Luz Matrícula

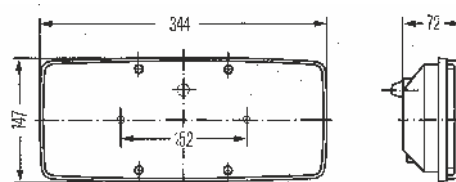

Function: Dir.Indicator-, Stop-, Rear-, Numberplate Lamp



Referencia: Reference-No.	Ud. QTY	Izq. left	Dch. right	Luz Matrícula Numberplate- lamp	Descripción - Referencia O.E. Specification - O.E.-No.	Conector - Accesorios - Recambios Connector - Accessories - Spare Parts
P40.206.002	1	■	■			
P40.206.003	1	■		■		
P40.206.004	1		■	■		
P40.206.102	2	■	■		Tulipa Lens	

Tipo: FORD TRANSTIT

Función: Luz Posición - Freno - Intermitente -
Marcha Atrás - Antiniebla

Function: Dir.Indicator-, Stop-, Rear-, Fog-, Reverse-,

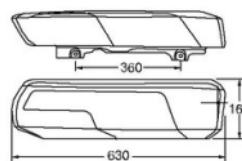

Referencia: Reference-No.	Ud. QTY	Izq. left	Dch. right	Luz Matrícula Numberplate- lamp	Descripción - Referencia O.E. Specification - O.E.-No.	Conector - Accesorios - Recambios Connector - Accessories - Spare Parts
S50.200.052	1		■			
S50.200.053	1	■				

Piloto Trasero

Rear Combination Lamp







Tipo: ECOPOINT

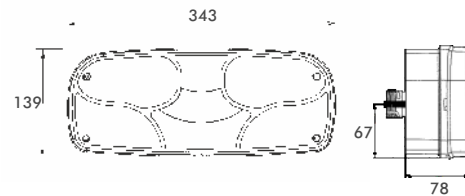

Función: Luz Posición - Freno - Intermitente -
 Marcha Atrás - Antiniebla - Luz Matrícula - Reflectante

Function: Dir.Indicator-, Stop-, Rear-, Fog-, Reverse-,
 Numberplate- Lamp, Reflex Reflector



Referencia: Reference-No.	Ud. QTY	Izq. left	Dch. right	Luz Matrícula Numberplate- lamp	Descripción - Referencia O.E. Specification - O.E.-No.	Conector - Accesorios - Recambios Connector - Accessories - Spare Parts
A25-2000-501	1	■			Aspöck 25-2000-507 Con Lámparas incluidas with bulbs fitted	
A25-2400-501	1		■		Aspöck 25-2400-507 Con Lámparas incluidas with bulbs fitted	
A25-2001-501	1	■		■	Aspöck 25-2001-507 Con Lámparas incluidas with bulbs fitted	
A25-2401-501	1		■	■	Aspöck 25-2401-507	
A18-8520-002	1	■	■		Tulipa Lens	
A13-5626-941	1	■			Aspöck 13-5626-941 Conector amarillo, para las versiones Aspöck ASS1 & ASS2 Connector yellow, for Aspöck ASS1 & ASS2 connector system	
A13-5626-951	1		■		Aspöck 13-5626-951 Conector verde, para las versiones Aspöck ASS1 & ASS2 Connector green, for Aspöck ASS1 & ASS2 connector system	

Piloto Trasero

Rear Combination Lamp

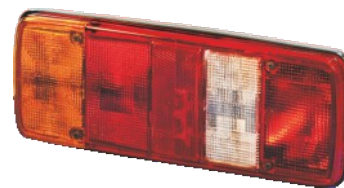



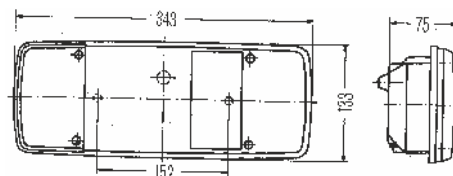

Tipo: 5 - Funciones / UNIVERSAL
sin Reflectante

Función: Luz Posición - Freno - Intermitente -
Marcha Atrás - Antiniebla - Luz Matrícula - Reflectante

Function: Dir.Indicator-, Stop-, Rear-, Fog-, Reverse-,
Numberplate Lamp
with Reflex Reflector



Referencia: Reference-No.	Ud. QTY	Izq. left	Dch. right	Luz Matrícula Numberplate- lamp	Descripción - Referencia O.E. Specification - O.E.-No.	Conector - Accesorios - Recambios Connector - Accessories - Spare Parts
P40.204.001	1	■				
P40.204.002	1		■			
P40.204.003	1	■		■		
P40.204.004	1		■	■		
P40.204.102	1		■			
P40.204.112	2	■	■		Tulipa para las Referencias: Lens for Reference	

Piloto Trasero

Rear Combination Lamp

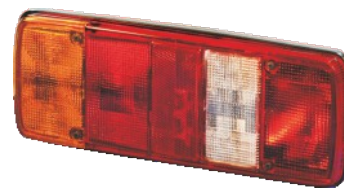

Tipo: M.A.N. / UNIVERSAL
con Reflectante

Función: Luz Posición - Freno - Intermitente -
Marcha Atrás - Antiniebla - Luz Matrícula - Reflectante

Function: Dir.Indicator-, Stop-, Rear-, Fog-, Reverse-,
Numberplate Lamp
with Reflex Reflector

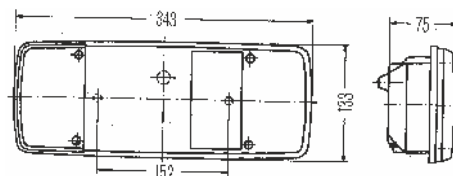

Referencia: Reference-No.	Ud. QTY	Izq. left	Dch. right	Luz Matrícula Numberplate- lamp	Descripción - Referencia O.E. Specification - O.E.-No.	Conector - Accesorios - Recambios Connector - Accessories - Spare Parts
P40.204.011	1	■				
P40.204.012	1		■			
P40.204.013	1	■		■		
S40.204.212	1	■			MAN 81.25228.6010	
S40.204.213	1		■		MAN 81.25228.6011	
P40.204.112	2	■	■		Tulipa para las Referencias: Lens for Reference 40 204 011, 40 204 012, 40 204 013	
P50.071.100	1	■	■		Kit Conecto AMP Repairkit	

Piloto Trasero

Rear Combination Lamp

Tipo: 3-Funciones MERCEDES BENZ

Función: Intermitente-, Freno-, Posición-, Luz Matrícula



Function: Dir.Indicator-, Stop-, Rear-, Numberplate Lamp

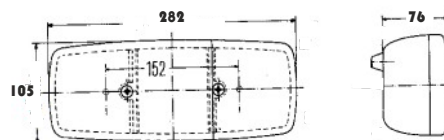

Referencia: Reference-No.	Ud. QTY	Izq. left	Dch. right	Luz Matrícula Numberplate- lamp	Descripción - Referencia O.E. Specification - O.E.-No.	Conector - Accesorios - Recambios Connector - Accessories - Spare Parts
P40.203.002	1	■	■			
P40.203.003	1	■	■	■		
P40.203.102	2	■	■		Tulipa Lens	

Tipo: 5-Funciones DAF / FORD TRANSIT

Función: Intermitente-, Freno-, Posición-, Luz Matrícula-
Antiniebla-, Marcha Atrás



Function: Dir.Indicator-, Stop-, Rear-, Fog-, Reversing-,
Number plate Lamp

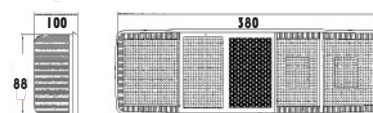

Referencia: Reference-No.	Ud. QTY	Izq. left	Dch. right	Luz Matrícula Numberplate- lamp	Descripción - Referencia O.E. Specification - O.E.-No.	Conector - Accesorios - Recambios Connector - Accessories - Spare Parts
P40.249.112/1	1	■	■	■	Tulipa Lens	

Piloto Trasero

Rear Combination Lamp



Tipo: IVECO - DAILY

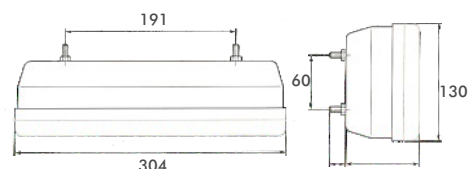

Función: Luz Posición - Freno - Intermitente -
Marcha Atrás - Antiniebla - Luz Matrícula -

Function: Dir.Indicator-, Stop-, Rear-, Fog-, Reverse Lamp,
Reflex Reflector

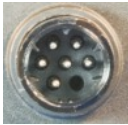

Referencia: Reference-No.	Ud. QTY	Izq. left	Dch. right	Luz Matrícula Numberplate- lamp	Descripción - Referencia O.E. Specification - O.E.-No.	Conector - Accesorios - Recambios Connector - Accessories - Spare Parts
P50.100.020	1	■			IVECO 69500032	
P50.100.021	1		■		IVECO 69500026	
P50.100.121	1	■	■		Tulipa Lens	
P50.071.100	1	■	■		Kit Conector AMP Repairkit	

Piloto Trasero

Rear Combination Lamp

Tipo: IVECO - DAILY / EUROCARGO

Función: Luz Posición - Freno - Intermitente -
Marcha Atrás - Antiniebla - Reflectante

Function: Dir.Indicator-, Stop-, Rear-, Fog-, Reverse Lamp,
Reflex Reflector

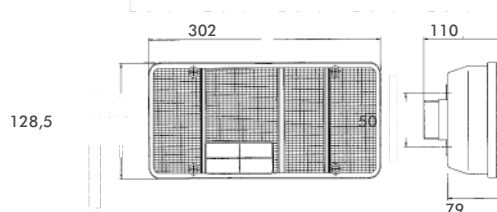

Referencia: Reference-No.	Ud. QTY	Izq. left	Dch. right	Luz Matrícula Numberplate- lamp	Anti- Niebla Fog- lamp	Marcha Atrás Reversing lamp	Descripción Referencia O.E. Specification - O.E.-No.	Conector - Accesorios Connector - Spare Parts
P40.211.011	1	■			■		4808775/73	
P40.211.012	1		■			■	4808774/72	
FA40.211.211	1	■			■		98424052	
FA40.211.212	1		■			■	98424051	
FA40.211.311	1	■			■		500356783 Daily S2000 10/99	
FA40.211.312	1		■			■	500356782 Daily S2000 10/99	
J80008001		■					C/ Cable 0,5m	
J80008002			■					
FA40.211.111	2	■			■		7984796 Tulipa	
FA40.211.112	2		■			■	Tulipa Lens	
FA40.211.113	2	■				■	7984794 Tulipa	
FA40.211.114	2		■		■		Tulipa Lens	

Piloto Trasero

Rear Combination Lamp

Tipo: 3-Funciones

Función: Intermitente-, Freno-, Posición-, Luz Matrícula

Function: Dir.Indicator-, Stop-, Rear-, Numberplate Lamp

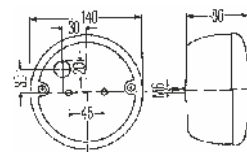

Referencia: Reference-No.	Ud. QTY	Izq. left	Dch. right	Luz Matrícula Numberplate- lamp	Descripción - Referencia O.E. Specification - O.E.-No.	Conector - Accesorios - Recambios Connector - Accessories - Spare Parts
P40.202.001	1	■	■			
P40.202.003	1	■	■	■		
P40.202.102	2	■	■		Tulipa Lens	

Tipo: 4 FUNCIONES

Función: Luz Posición - Freno - Intermitente -
Marcha Atrás - Antiniebla - Luz Matrícula - Reflectante
- Lámparas 12V incluidas

Function: Dir.Indicator-, Stop-, Rear-, Fog-, Reverse-,
Numberplate Lamp, Reflex Reflector
Bulbs 12V fitted

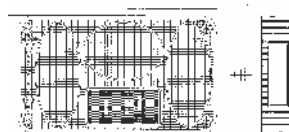

Referencia: Reference-No.	Ud. QTY	Izq. left	Dch. right	Luz Matrícula Numberplate- lamp	Anti- Niebla Fog- lamp	Marcha Atrás Reversing lamp	Descripción Referencia O.E. Specification - O.E.-No.	Conector - Accesorios Connector - Spare Parts
P40.232.311	1	■			■			
P40.232.312	1		■					
P40.232.313	1	■		■	■			
P40.232.314	1		■			■		
P40.232.411	1	■			■		Tulipa Lens	
P40.232.412	1		■				Tulipa Lens	
P40.232.413		■		■	■		Tulipa Lens	
P40.232.414			■			■	Tulipa Lens	

Piloto Trasero





Rear Combination Lamp

Tipo: 4 FUNCIONES

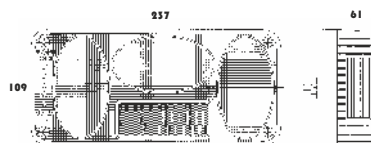
Función: Luz Posición - Freno - Intermitente -
 Marcha Atrás - Antiniebla - Luz Matrícula - Reflectante
 - Lámparas 12V incluidas

Function: Dir.Indicator-, Stop-, Rear-, Fog-, Reverse-,
 Numberplate Lamp, Reflex Reflector
 Bulbs 12V fitted



Referencia: Reference-No.	Ud. QTY	Izq. left	Dch. right	Luz Matrícula Numberplate- lamp	Anti- Niebla Fog- lamp	Marcha Atrás Reversing lamp	Descripción Referencia O.E. Specification - O.E.-No.	Conector - Accesorios Connector - Spare Parts
P40.232.011	1	■		■ lateral/ lateral	■			
P40.232.012	1		■	■ lateral/ lateral				
P40.232.013	1		■	■ lateral/ lateral		■		
P40.232.111	1	■	■			■	Tulipa Lens	
P40.232.112	1		■		■		Tulipa Lens	
P40.232.113	1	■	■			■	Kit Conector Repairkit	

Piloto Trasero

Rear Combination Lamp

Tipo: MIDIPOINT II

Función: Luz Posición - Freno - Intermitente -
Marcha Atrás - Antiniebla - Luz Matrícula - Reflectante
- Lámparas 12V incluidas

Function: Dir.Indicator-, Stop-, Rear-, Fog-, Reverse-,
Numberplate Lamp, Reflex Reflector
Bulbs 12V fitted

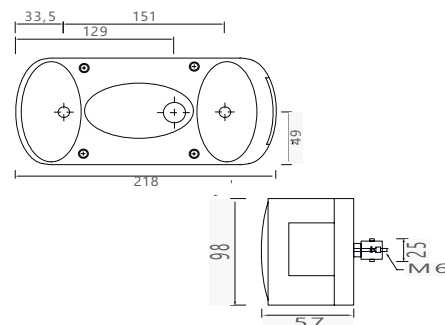

Referencia: Reference-No.	Ud. QTY	Izg. left	Dch. right	Luz Matrícula Numberplate- lamp	Anti- Niebla Fog- lamp	Marcha Atrás Reversing lamp	Descripción Referencia O.E. Specification - O.E.-No.	Conector - Accesorios Connector - Spare Parts
A24-3000-007	1	■	■	■ lateral/ lateral	■			
A24-3200-007	1		■	■ lateral/ lateral				
A24-3210-007	1	■	■	■ lateral/ lateral		■		
A18-8430-007	1	■	■		■		Tulipa Lens	
A18-8432-107	1		■			■	Tulipa Lens	
A13-0546-004	1	■	■			■	Kit Conector Repairkit	

Piloto Trasero





Rear Combination Lamp

Tipo: 4 FUNCIONES

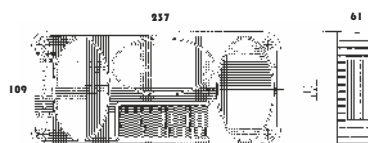
Función: Luz Posición - Freno - Intermitente -
 Marcha Atrás - Antiniebla - Luz Matrícula - Reflectante
 - Lámparas 12V incluidas

Function: Dir.Indicator-, Stop-, Rear-, Fog-, Reverse-,
 Numberplate Lamp, Reflex Reflector
 Bulbs 12V fitted



Referencia: Reference-No.	Ud. QTY	Izq. left	Dch. right	Luz Matrícula Numberplate- lamp	Anti- Niebla Fog- lamp	Marcha Atrás Reversing lamp	Descripción Referencia O.E. Specification - O.E.-No.	Conector - Accesorios Connector - Spare Parts
P40.232.011	1	■		■ lateral/ lateral	■			
P40.232.012	1		■	■ lateral/ lateral				
P40.232.013	1		■	■ lateral/ lateral		■		
P40.232.111	1	■	■			■	Tulipa Lens	
P40.232.112	1		■		■		Tulipa Lens	
P40.232.113	1	■	■			■	Kit Conector Repairkit	

Piloto Trasero

Rear Combination Lamp

Tipo: 4 FUNCIONES

Función: Luz Posición - Freno - Intermitente -
 Marcha Atrás - Antiniebla - Luz Matrícula - Reflectante

Function: Dir.Indicator-, Stop-, Rear-, Fog-, Reverse-,
 Numberplate Lamp, Reflex Reflector

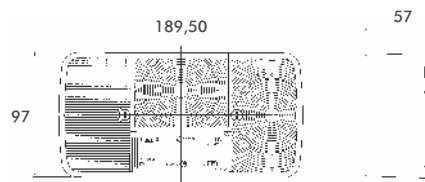

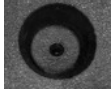
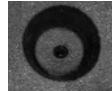
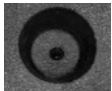
Referencia: Reference-No.	Ud. QTY	Izq. left	Dch. right	Luz Matrícula Numberplate- lamp	Anti- Niebla Fog- lamp	Marcha Atrás Reversing lamp	Descripción Referencia O.E. Specification - O.E.-No.	Conector - Accesorios Connector - Spare Parts
P40.222.013	1	■		■ lateral/ lateral	■			
P40.222.014	1		■	■ lateral/ lateral		■		
P40.222.015	1		■	■ lateral/ lateral	■			
P40.222.111	1	■				■	Tulipa Lens	
P40.222.112	1		■			■	Tulipa Lens	
P40.222.115	1		■		■		Tulipa Lens	

Piloto Trasero

Rear Combination Lamp

Tipo: MINIPOINT

Función: Luz Posición - Freno - Intermitente -
Luz Matrícula

Function: Dir.Indicator-, Stop-, Rear-, Numberplate Lamp

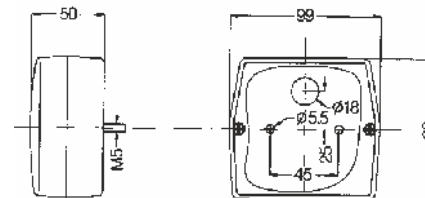
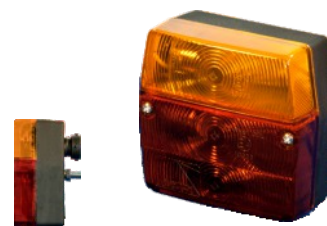

Referencia: Reference-No.	Ud. QTY	Izq. left	Dch. right	Luz Matrícula Numberplate- lamp	Descripción - Referencia O.E. Specification - O.E.-No.	Conector - Accesorios - Recambios Connector - Accessories - Spare Parts
A23-0200-007	1	■	■			
A23-0300-007	1	■	■	■ Tapa plástico with cover		
A23-0200-507	1	■	■		con bombillas 12V incluidas with bulbs 12V fitted	
A23-0300-507	2	■	■	■	con bombillas 12V incluidas with bulbs 12V fitted	
A18-8300-007	1	■	■	■ Tapa plástico with cover	Tulipa Lens	
A13-0546-004	1	■	■		Kit Conector Repairkit	

Piloto Trasero

Rear Combination Lamp

Función: Luz Posición - Freno - Intermitente -

Function: Dir.Indicator-, Stop-, Rear-, Numberplate Lamp



107,5

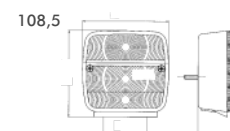

Referencia: Reference-No.	Ud. QTY	Izq. left	Dch. right	Luz Matrícula Numberplate- lamp	Descripción - Referencia O.E. Specification - O.E.-No.	Conector - Accesorios - Recambios Connector - Accessories - Spare Parts
P40.305.204	1	■	■	■		
P40.305.224	1	■	■			
P40.305.214	2	■	■		Tulipa Lens	

Piloto Trasero

Rear Combination Lamp

Tipo: 7-Funciones con Triángulo

Función: Luz Posición - Freno - Intermitente -
Marcha Atrás - Antiniebla - Luz Balizamiento
lateral - Triángulo Reflectante

Function: Dir.Indicator-, Stop-, Rear-, Fog-, Reverse-, End Outline
Marker-, Numberplate-, Sidemarkers Lamp,
Triangle Reflex Reflector

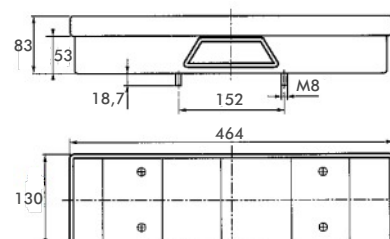
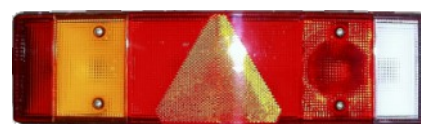

Referencia: Reference-No.	Ud. QTY	Izq. left	Dch. right	Luz Matrícula Numberplate- lamp	Descripción - Referencia O.E. Specification - O.E.-No.	Conector - Accesorios - Recambios Connector - Accessories - Spare Parts
P40.237.313/1	1	■		■		
P40.237.314/1	1		■	■		
P40.237.613/1	1	■		■		
P40.237.614/1	1		■	■		
P40.237.111/1	2	■			Tulipa Lens	
P40.237.112/1	2		■		Tulipa Lens	
P50.062.001	1	■	■		Luz posición lateral Insert Sidemarkers Lamp	

Piloto Trasero

Rear Combination Lamp





Tipo: 7-Funciones con Triángulo

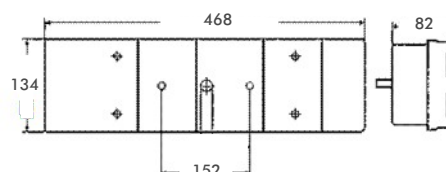

Función: Luz Posición - Freno - Intermitente -
 Marcha Atrás - Antiniebla - Luz Balizamiento
 lateral - Triángulo Reflectante

Function: Dir.Indicator-, Stop-, Rear-, Fog-, Reverse-, End Outline
 Marker-, Numberplate-, Sidemark Lamp,
 Triangle Reflex Reflector



Referencia: Reference-No.	Ud. QTY	Izq. left	Dch. right	Luz Matrícula Numberplate- lamp	Descripción - Referencia O.E. Specification - O.E.-No.	Conector - Accesorios - Recambios Connector - Accessories - Spare Parts
P40.240.011	1	■				
P40.240.012	1		■			
P40.240.013	1	■		■		
P40.240.111	1	■			Tulipa Lens	
P40.240.112	1		■		Tulipa Lens	
P50.062.001	1	■	■		Luz posición lateral Insert Sidemark Lamp	

Piloto Trasero

Rear Combination Lamp

Tipo: ECOPOINT II con triángulo 24V IP56K

Función: Luz Posición - Freno - Intermitente -
Marcha Atrás - Antiniebla - Luz Balizamiento
lateral - Triángulo Reflectante

Function: Dir.Indicator-, Stop-, Rear-, Fog-, Reverse-, End Outline
Marker-, Numberplate-, Sidemarker Lamp,
Triangle Reflex Reflector

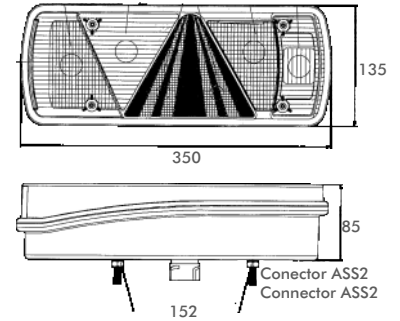

Referencia: Reference-No.	Ud. QTY	Izq. left	Dch. right	Luz Matrícula Numberplate- lamp	Descripción - Referencia O.E. Specification - O.E.-No.	Conector - Accesorios - Recambios Connector - Accessories - Spare Parts
A25-2800-501	1	■			O.E.: A25-2800-507 Versión con conector 7p ASS2 version with Aspöck ASS2 connector	
A25-2900-501	1		■		O.E.: A25-2900-507 Versión con conector 7p ASS2 version with Aspöck ASS2 connector	
A25-2801-501	1	■		■	O.E.: A25-2801-507 Versión con conector 7p ASS2 version with Aspöck ASS2 connector	
A25-2901-501	1		■	■	O.E.: A25-2901-507 Versión con conector 7p ASS2 version with Aspöck ASS2 connector	
A18-8528-002	1	■			Tulipa Lens	
A18-8529-002	1		■		Tulipa Lens	
A13-5626-941	1	■			Conector amarillo, para las versiones Aspöck ASS1 & ASS2 Connector yellow, for Aspöck ASS1 & ASS2 connector system	
A13-5626-951	1		■		Conector verde, para las versiones Aspöck ASS1 & ASS2 Connector green, for Aspöck ASS1 & ASS2 connector system	

Piloto Trasero





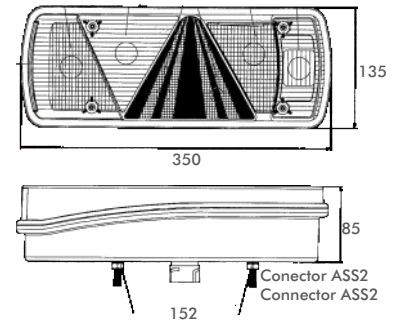

Rear Combination Lamp

Tipo: ECOPOINT II con triángulo 24V IP56K

Función: Luz Posición - Freno - Intermitente -
 Marcha Atrás - Antiniebla - Luz Balizamiento
 lateral - Triángulo Reflectante

Function: Dir.Indicator-, Stop-, Rear-, Fog-, Reverse-, End Outline
 Marker-, Numberplate-, Sidemarker Lamp,
 Triangle Reflex Reflector



Referencia: Reference-No.	Ud. QTY	Izq. left	Dch. right	Luz Matrícula Numberplate- lamp	Descripción - Referencia O.E. Specification - O.E.-No.	Conector - Accesorios - Recambios Connector - Accessories - Spare Parts
A25-2800-511	1	■			Aspöck O.E.: A25-2800-517 Versión conector 7p ASS2.1 + 2x2p ASS2 version with ASS2 7p + 2x2p ASS2 connector	
A25-2900-511	1		■		Aspöck O.E.: A25-2900-517 Versión conector 7p ASS2.1 + 4x2p ASS2 version with ASS2 7p + 4x2p ASS2 connector	
A25-2880-521	1	■			Aspöck O.E.: A25-2880-527 Versión con conector 7p. AMP version with 7p.AMP connector	
A25-2980-521	1		■		Aspöck O.E.: A25-2980-527 Versión con conector 7p AMP version with 7p.AMP connector	
A18-8528-002	1	■			Tulipa Lens	
A18-8529-002	1		■		Tulipa Lens	
A13-5626-941	1	■			Conector amarillo, para las versiones Aspöck ASS1 & ASS2 Connector yellow, for Aspöck ASS1 & ASS2 connector system	
A13-5626-951	1		■		Conector verde, para las versiones Aspöck ASS1 & ASS2 Connector green, for Aspöck ASS1 & ASS2 connector system	
P50.071.100	1	■	■		Kit Conector AMP Repairkit	

Piloto Trasero







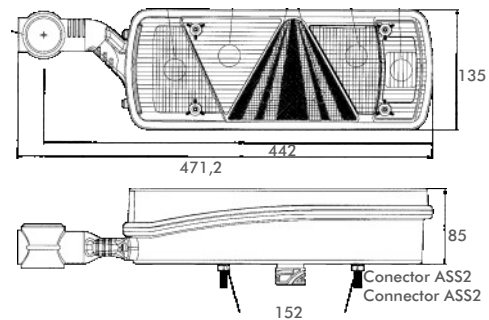

Rear Combination Lamp

Tipo: ECOPOINT II 24V IP56K

Función: Luz Posición - Freno - Intermitente -
Marcha Atrás - Antiniebla - Cuerno Balizamiento
y Posición lateral - Triángulo Reflectante

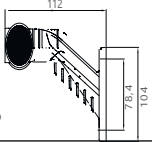
Function: Dir.Indicator-, Stop-, Rear-, Fog-, Reverse-, End Outline
Marker-, Sidemarker Lamp, Triangle Reflex Reflector



Referencia: Reference-No.	Ud. QTY	Izq. left	Dch. right	Luz Matrícula Numberplate- lamp	Descripción - Referencia O.E. Specification - O.E.-No.	Conector - Accesorios - Recambios Connector - Accessories - Spare Parts
A25-2810-501	1	■			O.E.: A25-2810-507 Versión con conector 7p ASS2 7p ASS2 Connector	
A25-2910-501	1		■		O.E.: A25-2910-507 Versión con conector 7p ASS2 7p ASS2 Connector	
A25-2811-501	1	■		■	O.E.: A25-2811-507 Versión con conector 7p ASS2 7p ASS2 Connector	
A25-2911-501	1		■	■	O.E.: A25-2911-507 Versión con conector 7p ASS2 7p ASS2 Connector	
A18-8528-002	1	■			Tulipa Lens	
A18-8529-002	1		■		Tulipa Lens	
A31-3303-024		■			O.E.: A31-3303-027	  Corto
A31-3302-024			■		O.E.: A31-3302-027	
A15-5277-004	1		■	■	Tapa protectora trasera Ecopoint II Protection cap	
A13-5626-941	1	■			Conector amarillo, para las versiones Aspöck ASS1 & ASS2 Connector yellow, for Aspöck ASS1 & ASS2 connector system	
A13-5626-951	1		■		Conector verde, para las versiones Aspöck ASS1 & ASS2 Connector green, for Aspöck ASS1 & ASS2 connector system	

Piloto Trasero





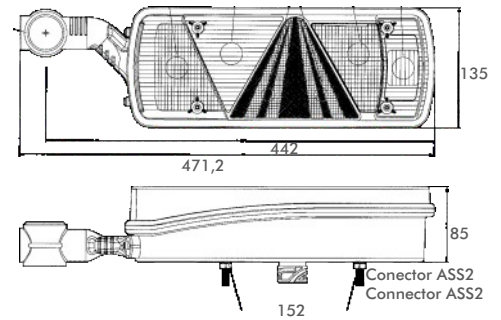

Rear Combination Lamp

Tipo: ECOPOINT II 24V IP56K

Función: Luz Posición - Freno - Intermitente -
Marcha Atrás - Antiniebla - Cuerno Balizamiento
y Posición lateral - Triángulo Reflectante

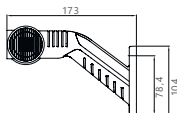
Function: Dir.Indicator-, Stop-, Rear-, Fog-, Reverse-, End Outline
Marker-, Sidemarker Lamp, Triangle Reflex Reflector



Referencia: Reference-No.	Ud. QTY	Izq. left	Dch. right	Luz Matrícula Numberplate- lamp	Descripción - Referencia O.E. Specification - O.E.-No.	Conector - Accesorios - Recambios Connector - Accessories - Spare Parts
A25-2831-501	1	■		■	O.E.: A25-2831-507 Versión conector 7p ASS2.1 + 2 conectores 2p ASS2 ver. 7p ASS2 + 4x2p connector	 LECITRAILER
A25-2931-501	1		■	■	O.E.: A25-2931-507 Versión conector 7p ASS2.1 + 2 conectores 2p ASS2 ver. 7p ASS2 + 4x2p connector	 LECITRAILER
A31-3302-034	1		■		O.E.: A31-3302-037 Versión corta con cable 0.3m y puntas abiertas Version Cable 0.3 M	
A31-3303-034	1	■			O.E.: A31-3303-037 Versión corta con cable 0.3m y puntas abiertas Version Cable 0.3 M	Largo 
A18-8528-002	1	■			Tulipa Lens	
A18-8529-002	1		■		Tulipa Lens	
A13-5626-941	1	■			Conector amarillo, para las versiones Aspöck ASS1 & ASS2 Connector yellow, for Aspöck ASS1 & ASS2 connector system	
A13-5626-951	1		■		Conector verde, para las versiones Aspöck ASS1 & ASS2 Connector green, for Aspöck ASS1 & ASS2 connector system	
A13-5626-295	1	■	■		Conector 2p ASS2 2p ASS2 connector	

Piloto Trasero









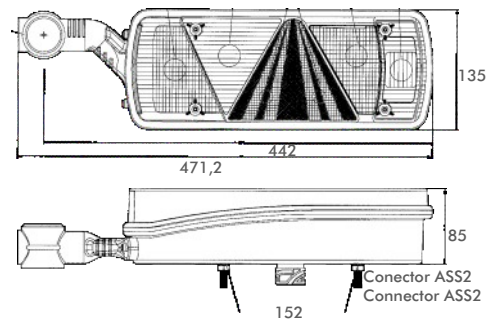

Rear Combination Lamp

Tipo: ECOPOINT II 24V IP56K

Función: Luz Posición - Freno - Intermitente -
 Marcha Atrás - Antiniebla - Cuerno Balizamiento
 y Posición lateral - Triángulo Reflectante

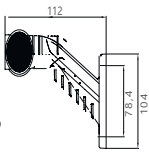
Function: Dir.Indicator-, Stop-, Rear-, Fog-, Reverse-, End Outline
 Marker-, Sidemarker Lamp, Triangle Reflex Reflector



Referencia: Reference-No.	Ud. QTY	Izq. left	Dch. right	Luz Matrícula Numberplate- lamp	Descripción - Referencia O.E. Specification - O.E.-No.	Conector - Accesorios - Recambios Connector - Accessories - Spare Parts
A25-2810-511	1	■			O.E.: A25-2810-517 Versión conector 7p ASS2.1 + 2 conectores 2p ASS2 Version with 3 Connectors	 TISVOL
A25-2910-511	1		■		O.E.: A25-2910-517 Versión conector 7p ASS2.1 + 2 conectores 2p ASS2 Version with 3 Connectors	 TISVOL
A25-2910-551	1		■		O.E.: A25-2910-557 Ver. 7p ASS2.1 + 2 ASS2 + Avisador acústico Version 7p. ASS2.1 + 2 ASS2 Connector + Back Alarm	
A25-2911-551	1		■	■	O.E.: A25-2911-557 Versión conector 7p ASS2.1 + Avisador acústico Version with 7p. ASS2.1 Connector + Back Alarm	
A18-8528-002	1	■			Tulipa Lens	
A18-8529-002	1		■		Tulipa Lens	
A31-3303-024		■			Aspöck 31-3303-027	 Corto 
A31-3302-024			■		Aspöck 31-3302-027	
A13-5626-941	1	■			Conector amarillo, para las versiones Aspöck ASS1 & ASS2 Connector yellow, for Aspöck ASS1 & ASS2 connector system	
A13-5626-951	1		■		Conector verde, para las versiones Aspöck ASS1 & ASS2 Connector green, for Aspöck ASS1 & ASS2 connector system	
A13-5626-295	1	■	■		Conector 2p ASS2 2p ASS2 connector	

Piloto Trasero

Rear Combination Lamp

Tipo: ECOPOINT II 24V IP56K

Función: Luz Posición - Freno - Intermitente -
 Marcha Atrás - Antiniebla - Cuerno Balizamiento LED
 y Posición lateral - Triángulo Reflectante

Function: Dir.Indicator-, Stop-, Rear-, Fog-, Reverse-, End Outline
 Marker-, Sidemarker Lamp, Triangle Reflex Reflector

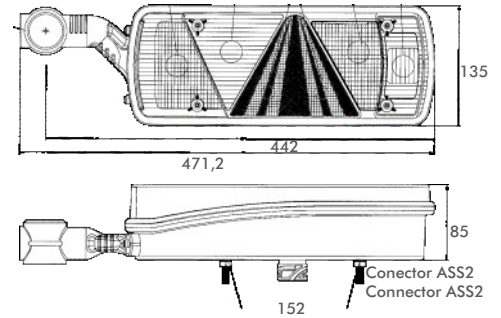

Referencia: Reference-No.	Ud. QTY	Izq. left	Dch. right	Luz Matrícula Numberplate- lamp	Descripción - Referencia O.E. Specification - O.E.-No.	Conector - Accesorios - Recambios Connector - Accessories - Spare Parts
A25-2820-501	1	■			O.E.: A25-2820-507 Versión conector 7p ASS2.1 + cuerno LED ver. 7p ASS2 + LED end out line	 Cuerno LED
A25-2920-501	1		■		O.E.: A25-2920-507 Versión conector 7p ASS2.1 + cuerno LED ver. 7p ASS2 + LED end out line	 Cuerno LED
A25-2820-541	1	■			O.E.: A25-2820-547 Versión conector 7p ASS2.1 + 2 conectores 2p ASS2 Version with 3 Connectors	 Cuerno LED
A25-2920-541	1		■		O.E.: A25-2920-547 Versión conector 7p ASS2.1 + 2 conectores 2p ASS2 Version with 3 Connectors	 Cuerno LED
A25-2880-531	1	■			O.E.: A25-2880-537 Versión conector 7p AMP + 2 conectores 2p Superseal Version with 3 Connectors	 Cuerno LED
A25-2980-531	1		■		O.E.: A25-2980-547 Versión conector 7p AMP + 2 conectores 2p Superseal Version with 3 Connectors	 Cuerno LED
A31-3303-104	1	■			O.E.: A31-3303-104 Versión: Largo	
A31-3302-104	1		■		O.E.: A31-3302-104 Versión: Largo	
A31-3303-044	1	■			O.E.: A31-3303-044 Versión: Corto	
A31-3302-044	1		■		O.E.: A31-3302-044 Versión: Corto	

Piloto Trasero



Rear Combination Lamp

Tipo: ECOPOINT II 24V IP56K

Función: Luz Posición - Freno - Intermitente -
 Marcha Atrás - Antiniebla - Cuerno Balizamiento LED
 y Posición lateral - Triángulo Reflectante

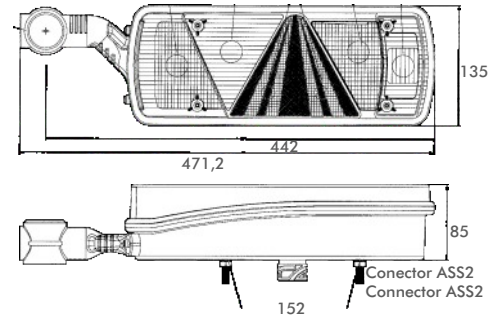
Function: Dir.Indicator-, Stop-, Rear-, Fog-, Reverse-, End Outline
 Marker-, Sidemarker Lamp, Triangle Reflex Reflector



Referencia: Reference-No.	Ud. QTY	Izq. left	Dch. right	Luz Matrícula Numberplate- lamp	Descripción - Referencia O.E. Specification - O.E.-No.	Conector - Accesorios - Recambios Connector - Accessories - Spare Parts
A25-2810-451	1	■			O.E.: A25-2810-457 Versión conector 7p ASS2.1 + Posición/freno/cuerno LED ver. 7p ASS2 + LED end out line	 Cuerno Largo
A25-2910-451	1		■		O.E.: A25-2910-457 Versión conector 7p ASS2.1 + Posición/freno/cuerno LED ver. 7p ASS2 + LED end out line	 Cuerno Largo
A12-1522-154	1	■			O.E.: A12-1522-157 Función: Intermitente LED Funcion: LED Direction Indicator	 Intermitente LED
A12-1526-154	1		■		O.E.: A12-1522-157 Función: Intermitente LED Funcion: LED Direction Indicator	 Intermitente LED
A12-1522-144	1	■			O.E.: A12-1522-147 Función: Marcha Atrás LED Function: LED Reverse	 Marcha atrás LED
A12-1526-144	1		■		O.E.: A12-1526-147 Función: Marcha Atrás LED Function: LED Reverse	 Marcha atrás LED
A12-1526-164	1	■	■		O.E.: A12-1526-167 Función: Antiniebla LED Function: LED Fog	 Antiniebla LED
A12-1528-001	1	■			O.E.: A12-1528-007 Función: Posición y Freno LED Function: LED tail and stop lamp	 Posición y Freno LED
A12-1529-001	1		■		O.E.: A12-1529-007 Función: Posición y Freno LED Function: LED tail and stop lamp	 Posición y Freno LED
A12-3922-004	1	■	■		O.E.: A12-3922-007 Avisador Acústico	
A12-3970-584	1	■	■		O.E.: A12-3970-587 Controlador Intermitencia R48	

Piloto Trasero

Rear Combination Lamp







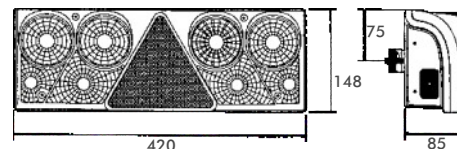

Tipo: EUROPOINT II 24V

Función: Luz Posición - Freno - Intermitente -
 Marcha Atrás - Antiniebla - Balizamiento
 Posición lateral - Luz Matricula - Triángulo Reflectante
 Opcional Módulo LED

Function: Dir.Indicator-, Stop-, Rear-, Fog-, Reverse-, End Outline
 Marker-, Numberplate-, Sidemarket Lamp,
 Triangle Reflex Reflector, Opt. LED Module



Referencia: Reference-No.	Ud. QTY	Izq. left	Dch. right	Luz Matricula Numberplate- lamp	Descripción - Referencia O.E. Specification - O.E.-No.	Conector - Accesorios - Recambios Connector - Accessories - Spare Parts
A25-6000-501		■			O.E.: A25-6000-507 Versión con conector 7p ASS2 Version 7p ASS2 connector	
A25-6400-501	1		■		O.E.: A25-6400-507 Versión con conector 7p ASS2 Version 7p ASS2 connector	
A25-6001-501	1	■		■	O.E.: A25-6001-507 Versión con conector 7p ASS2 Version 7p ASS2 connector	
A25-6401-501	1		■	■	O.E.: A25-6401-507 Versión con conector 7p ASS2 Version 7p ASS2 connector	
A18-8560-002	2	■	■		Kit 2 Tulipas Set two Lens	
A13-5626-941	1	■			Conector amarillo, para las versiones Aspöck ASS1 & ASS2 Connector yellow, for Aspöck ASS1 & ASS2 connector system	
A13-5626-951	1		■		Conector verde, para las versiones Aspöck ASS1 & ASS2 Connector green, for Aspöck ASS1 & ASS2 connector system	
A12-3922-004	1	■	■		Avisador acústico para colocar en el interior del piloto Back Alarm System to fit into the Rear Lamp Housing	



Parte posterior
Backside



TIPO: TRASERAS LECITRAILER II

Descripción: Europoint II montado en una carcasa de plástico muy resistente, soporte metálico de tubo corto 1.300 - ext. 20, cuerno lateral Superpoint II de 05,m cable y conector ASPÖCK P&R, cantonera roja + reflectante redondo ámbar, y conector 7p.+ 4 salidas libres, protegidas con rácor pasacables y goma para estanqueidad, en la parte posterior.

Función: Intermitente-, Freno-, Doble Posición-, Antiniebla-, Marcha atrás-, Posición lateral-,Luz matrícula-, Balizamiento lateral-, Triángulo reflectante, **Bombillas incluidas**









Description: Europoint II Lamp mounted in a Black Solid Plastic Holder, Short Metallic Bracket 1.300 - Ext. 20, End Outline Marker Superpoint II with Cable 0,5m and Aspöck P&R Connector, Red Corner + Round amber Reflex Reflector and 7 pins Conector + 4 PG-Screws, with Boots for Sealing, at the Backside.

Function: Dir.Indicator-, Stop-, Double Rear-, Fog-, Reverse-, End Outline Marker-, Numberplate-, Sidemarkerlamp, Triangle-Reflex Reflector, **Bulbs fitted**

Referencia: Reference-No.	Ud. QTY	Izqdo. left	Dcho. right	Luz Matrícula Numberplate- lamp	Descripción - O.E. Number Specification - O.E.-No.	Conector - Accesorios - Recambios Connector - Accessories - Spare Parts
A35-5155-101	1	■		■	Ref. Lecitrailer 4081891 Soporte Recto	
A35-5556-101	1		■	■	Ref. Lecitrailer 4081881 Soporte Recto	
A35-5155-121	1	■		■	Ref. Lecitrailer 4081901 Soporte Curvo	
A35-5556-121	1		■	■	Ref. Lecitrailer 4081911 Soporte Curvo	

Componentes Traseras



Referencia: Reference-No.	Ud. QTY	Descripción - O.E. Number Specification - O.E.-No.	Conector - Accesorios - Recambios Connector - Accessories - Spare Parts
A15-5412-007	1	Reflectante ámbar redondo. Round amber reflex reflector	
L9700120/1	1	Carcasa derecha de resistente plástico negro. Black solid plastic right holder	
L9700130/1	1	Carcasa izquierda de resistente plástico negro. Black solid plastic left holder	
L4040100	1	Cantonera roja derecha de plástico translúcido. Red plastic transparent right corner	
L4040110	1	Cantonera izquierda roja derecha de plástico translúcido. Red plastic transparent left corner	
L3230510	1	Soporte metálico de tubo corto 1300mm ext. 20 recto. Short metalic straight bracket 1300	
L3230520	1	Soporte metálico de tubo corto 1300mm ext. 20 curvo. Short metalic bent bracket 1300	
A25-6201-501	1	O.E.: A25-6201-507 Piloto Europoint II izq. para trasera Lecitrailer. Rear combination lamp Europoint II left special Lecitrailer	
A25-6601-511	1	O.E.: A25-6601-517 Piloto Europoint II dch. para trasera Lecitrailer. Rear combination lamp Europoint II right special Lecitrailer	
A31-3704-017	1	Gálibo Superpoint II roja/blanca/ámbar, brazo de goma flexible corto, 1,5m P&R. End outline marker Superpoint II, lens red/white/amber, flex bracket 1.5m P&R	

Piloto Trasero

Rear Combination Lamp









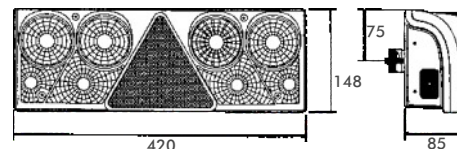

Tipo: EUROPOINT II 24V

Función: Luz Posición - Freno - Intermitente -
Marcha Atrás - Antiniebla - Balizamiento
Posición lateral - Luz Matricula - Triángulo Reflectante
Opcional Módulo LED

Function: Dir.Indicator-, Stop-, Rear-, Fog-, Reverse-, End Outline
Marker-, Numberplate-, Sidemarket Lamp,
Triangle Reflex Reflector, Opt. LED Module



Referencia: Reference-No.	Ud. QTY	Izq. left	Dch. right	Luz Matricula Numberplate- lamp	Descripción - Referencia O.E. Specification - O.E.-No.	Conector - Accesorios - Recambios Connector - Accessories - Spare Parts
A25-6201-501		■		■	O.E.: A25-6201-507 Versión con 1 conector 7p ASS2.1 + 4 conectores 2p ASS2 Version 7p ASS2.1 + 4x 2p ASS2 connector	 Con Balizamiento lateral
A25-6601-511	1		■	■	O.E.: A25-6601-517 Versión con 1 conector 7p ASS2.1 + 4 conectores 2p ASS2 Version 7p ASS2.1 + 4x 2p ASS2 connector	 Con Balizamiento lateral Con Avisador Acústico
A25-6201-511	1	■		■	O.E.: A25-6201-517 Versión con 1 conector 7p ASS2.1 + 4 conectores 2p ASS2 Version 7p ASS2.1 + 4x 2p ASS2 connector	 Sin Balizamiento lateral
A25-6601-521	1		■	■	O.E.: A25-6601-527 Versión con 1 conector 7p ASS2.1 + 4 conectores 2p ASS2 Version 7p ASS2.1 + 4x 2p ASS2 connector	 Sin Balizamiento lateral Con Avisador Acústico
A18-8560-002	2	■	■		Kit 2 Tulipas Set two Lens	
A13-5626-941	1	■			Conector amarillo, para las versiones Aspöck ASS1 & ASS2 Connector yellow, for Aspöck ASS1 & ASS2 connector system	
A13-5626-951	1		■		Conector verde, para las versiones Aspöck ASS1 & ASS2 Connector green, for Aspöck ASS1 & ASS2 connector system	
A13-5626-295	1	■	■		Conector 2p ASS2 2p ASS2 connector	

Piloto Trasero

Rear Combination Lamp

Tipo: EUROPOINT II 24V Version SCHMITZ
Conector AMP



Función: Luz Posición - Freno - Intermitente -
Marcha Atrás - Antiniebla - Luz Matrícula -
Triángulo Reflectante
Opcional Módulo LED

Function: Dir.Indicator-, Stop-, Rear-, Fog-, Reverse-, End Outline
Marker-, Numberplate-, Sidemarket Lamp,
Triangle Reflex Reflector, Opt. LED Module

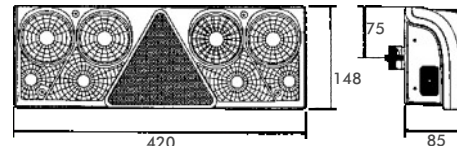

Referencia: Reference-No.	Ud. QTY	Izq. left	Dch. right	Luz Matrícula Numberplate- lamp	Descripción - Referencia O.E. Specification - O.E.-No.	Conector - Accesorios - Recambios Connector - Accessories - Spare Parts
A25-6030-501	1	■			O.E.: A25-6030-507 Versión conectores 7p. AMP + 4x2p. Superseal, Luz de Posición con Módulo LED 7p AMP Connector + 4x2 Sup. incl. bulbs + LED Module	 Sin Balizamiento lateral
A25-6430-501	1		■		O.E.: A25-6430-507 Versión conectores 7p. AMP + 4x2p. Superseal, Luz de Posición con Módulo LED 7p AMP Connector + 4x2 Sup. incl. bulbs + LED Module	 Sin Balizamiento lateral
A25-6030-701	1	■			O.E.: A25-6030-707 Versión conectores 7p. AMP + 4x2p. Superseal, completo LED 7p AMP Connector + 4x2 Sup. incl. bulbs + full LED	 Sin Balizamiento lateral
A25-6430-701	1		■		O.E.: A25-6430-707 Versión conectores 7p. AMP + 4x2p. Superseal, completo LED 7p AMP Connector + 4x2 Sup. incl. bulbs + full LED	 Sin Balizamiento lateral
A18-8560-002	2	■	■		Kit 2 Tulipas Lens	
A15-7002-024	1	■			Conector 7 p. AMP Connector AMP 7 poles	
A15-7002-044	1		■		Conector Superseal 2p. Connector Superseal 2 poles	
A12-3922-004	1	■	■		Avisador acústico para colocar en el interior del piloto Back Alarm System to fit into the Rear Lamp Housing	

Piloto Trasero

Rear Combination Lamp







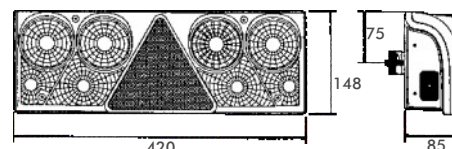

Tipo: EUROPOINT II 24V Version SCHMITZ
Conectores ASS1 & ASS2



Función: Luz Posición - Freno - Intermitente -
Marcha Atrás - Antiniebla - Luz Matrícula -
Triángulo Reflectante
Opcional Módulo LED

Function: Dir.Indicator-, Stop-, Rear-, Fog-, Reverse-, End Outline
Marker-, Numberplate-, Sidemarker Lamp,
Triangle Reflex Reflector, Opt. LED Module



Referencia: Reference-No.	Ud. QTY	Izq. left	Dch. right	Luz Matrícula Numberplate- lamp	Descripción - Referencia O.E. Specification - O.E.-No.	Conector - Accesorios - Recambios Connector - Accessories - Spare Parts
A25-6010-501	1	■			O.E.: A25-6010-507 1 Conec. 7p ASS2 + 4x2p. ASS2 Luz de Posición con Mód. LED ASS1 / ASS2 1 Connector + 4 Connector 2 pins.	 Sin Balizamiento lateral
A25-6410-501	1		■		O.E.: A25-6410-507 1 Conec. 7p ASS2 + 4x2p. ASS2 Luz de Posición con Mód. LED ASS1 / ASS2 1 Connector + 4 Connector 2 pins.	 Sin Balizamiento lateral
A25-6011-501	1	■		■	O.E.: A25-6011-507 1 Conec. 7p ASS2 + 4x2p. ASS1 Luz de Posición con Mód. LED ASS1 / ASS2 1 Connector + 4 Conn. 2 pins. LED Numberplate	 Sin Balizamiento lateral
A25-6411-501	1		■	■	O.E.: A25-6411-507 1 Conec. 7p ASS2 + 4x2p. ASS1 Luz de Posición con Mód. LED ASS1 / ASS2 1 Connector + 4 Conn. 2 pins. LED Numberplate	 Sin Balizamiento lateral
A18-8560-002	2	■	■		Kit 2 tulipas Lens	
A13-5626-941	1	■			Conector amarillo, para las versiones Aspöck ASS1 & ASS2 Connector yellow, for Aspöck ASS1 & ASS2 connector system	
A13-5626-951	1		■		Conector verde, para las versiones Aspöck ASS1 & ASS2 Connector green, for Aspöck ASS1 & ASS2 connector system	
A13-5626-295	1	■	■		Conector Aspöck 2P Connector 2p.	
A15-5276-007	1	■	■		Tapa protectora trasera Cover back	

Piloto Trasero

Rear Combination Lamp

Tipo: EUROPOINT II 24V Version SCHMITZ
Conector AMP



Función: Luz Posición - Freno - Intermitente -
Marcha Atrás - Antiniebla - Luz Matrícula -
Triángulo Reflectante
Opcional Módulo LED

Function: Dir.Indicator-, Stop-, Rear-, Fog-, Reverse-, End Outline
Marker-, Numberplate-, Sidemarket Lamp,
Triangle Reflex Reflector, Opt. LED Module

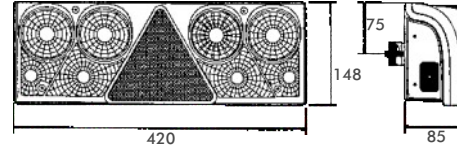

Referencia: Reference-No.	Ud. QTY	Izq. left	Dch. right	Luz Matrícula Numberplate- lamp	Descripción - Referencia O.E. Specification - O.E.-No.	Conector - Accesorios - Recambios Connector - Accessories - Spare Parts
A25-6030-501	1	■			O.E.: A25-6030-507 Versión conectores 7p. AMP + 4x2p. Superseal, Luz de Posición con Módulo LED 7p AMP Connector + 4x2p Sup. incl. bulbs + LED Module	 Sin Balizamiento lateral
A25-6430-501	1		■		O.E.: A25-6430-507 Versión conectores 7p. AMP + 4x2p. Superseal, Luz de Posición con Módulo LED 7p AMP Connector + 4x2p Sup. incl. bulbs + LED Module	 Sin Balizamiento lateral
A25-6030-701	1	■			O.E.: A25-6030-707 Versión conectores 7p. AMP + 4x2p. Superseal, completo LED 7p AMP Connector + 4x2p Sup. incl. bulbs + full LED	 Sin Balizamiento lateral
A25-6430-701	1		■		O.E.: A25-6430-707 Versión conectores 7p. AMP + 4x2p. Superseal, completo LED 7p AMP Connector + 4x2p Sup. incl. bulbs + full LED	 Sin Balizamiento lateral
A18-8560-002	2	■	■		Kit 2 Tulipas Lens	
A15-7002-024	1	■			Conector 7 p. AMP Connector AMP 7 poles	
A15-7002-044	1		■		Conector Superseal 2p. Connector Superseal 2 poles	
A12-3922-004	1	■	■		Avisador acústico para colocar en el interior del piloto Back Alarm System to fit into the Rear Lamp Housing	

Piloto Trasero

Rear Combination Lamp









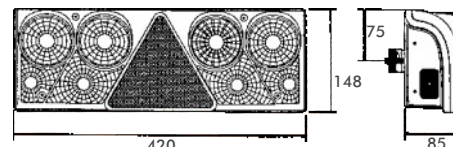



Tipo: EUROPOINT II 24V

Función: Luz Posición - Freno - Intermitente -
 Marcha Atrás - Antiniebla - Balizamiento
 Posición lateral - Luz Matrícula - Triángulo Reflectante
 Opcional Módulo LED

Function: Dir.Indicator-, Stop-, Rear-, Fog-, Reverse-, End Outline
 Marker-, Numberplate-, Sidemarket Lamp,
 Triangle Reflex Reflector, Opt. LED Module



Referencia: Reference-No.	Ud. QTY	Izq. left	Dch. right	Luz Matrícula Numberplate- lamp	Descripción - Referencia O.E. Specification - O.E.-No.	Conector - Accesorios - Recambios Connector - Accessories - Spare Parts
A25-6000-701		■			O.E.: A25-6000-707 Versión con conector 7p ASS2 Luz Posición con Módulo LED Version 7p ASS2 connector Led Position lamp	 Con balizamiento lateral
A25-6400-701	1		■		O.E.: A25-6400-707 Versión con conector 7p ASS2 Luz Posición con Módulo LED Version 7p ASS2 connector Led Position lamp	 Con balizamiento lateral
A25-6000-711	1	■			O.E.: A25-6000-717 Versión con conector 7p ASS2 Luz Posición con Módulo LED Version 7p ASS2 connector Led Position lamp	 Sin balizamiento lateral
A25-6400-711	1		■		O.E.: A25-6400-717 Versión con conector 7p ASS2 Luz Posición con Módulo LED Version 7p ASS2 connector Led Position lamp	 Sin balizamiento lateral
A25-6000-721	1	■			O.E.: A25-6000-727 Versión con conector 7p ASS2 Posición/Freno/Intermitente LED Version 7p ASS2 connector Led tail/brake/Dir. Indicator	 Con balizamiento lateral
A25-6400-721	1		■		O.E.: A25-6400-727 Versión con conector 7p ASS2 Posición/Freno/Intermitente LED Version 7p ASS2 connector Led tail/brake/Dir. Indicator	 Con balizamiento lateral
A25-6000-741	1	■			O.E.: A25-6000-747 Versión con conector 7p ASS2 Posición/Freno Módulo LED Version 7p ASS2 connector Led tail/brake/Dir. Indicator	 Con balizamiento lateral
A25-6400-741	1		■		O.E.: A25-6400-747 Versión con conector 7p ASS2 Posición/Freno Módulo LED Version 7p ASS2 connector Led tail/brake/Dir. Indicator	 Con balizamiento lateral
A25-6000-751	1	■			O.E.: A25-6000-757 Versión con conector 7p ASS2 Completo LED Version 7p ASS2 connector Full LED	 Con balizamiento lateral
A25-6400-751	1		■		O.E.: A25-6400-757 Versión con conector 7p ASS2 Completo LED Version 7p ASS2 connector Full LED	 Con balizamiento lateral

Piloto Trasero

Rear Combination Lamp



Tipo: EUROPOINT II 24V

Función: Luz Posición - Freno - Intermitente -
Marcha Atrás - Antiniebla - Balizamiento
Posición lateral - Luz Matrícula - Triángulo Reflectante
Opcional Módulo LED

Function: Dir.Indicator-, Stop-, Rear-, Fog-, Reverse-, End Outline
Marker-, Numberplate-, Sidemarker Lamp,
Triangle Reflex Reflector, Opt. LED Module

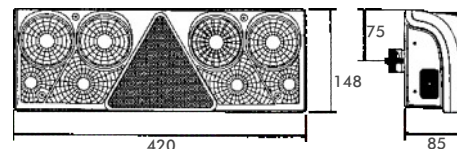

Referencia: Reference-No.	Ud. QTY	Izq. left	Dch. right	Luz Matrícula Numberplate- lamp	Descripción - Referencia O.E. Specification - O.E.-No.	Conector - Accesorios - Recambios Connector - Accessories - Spare Parts
A25-6030-711		■			O.E.: A25-6030-717 Versión conectores 7p. AMP + 4x2p. Superseal 7p AMP Connector + 4x2p Superseal	 Sin balizamiento lateral
A25-6430-711	1		■		O.E.: A25-6430-717 Versión conectores 7p. AMP + 4x2p. Superseal 7p AMP Connector + 4x2p Superseal	 Sin balizamiento lateral
A25-6101-501	1	■		■	O.E.: A25-6101-507 Versión con conector 7p ASS2 + 2x2p ASS2 Version 7p ASS2 + 2x2p ASS2 connector	 Con balizamiento lateral
A25-6501-511	1		■	■	O.E.: A25-6501-517 Versión con conector 7p ASS2 + 2x2p ASS2 + Avisador Acústico Version 7p ASS2 + 2x2p ASS2 connector + reverse alarm	 Con balizamiento lateral
A25-6200-501	1	■			O.E.: A25-6200-507 Versión con conector 7p ASS2 + 4x2p ASS2 Version 7p ASS2 + 4x2p ASS2 connector	 Con balizamiento lateral
A25-6600-501	1		■		O.E.: A25-6600-507 Versión con conector 7p ASS2 + 4x2p ASS2 Version 7p ASS2 + 4x2p ASS2 connector	 Con balizamiento lateral

Piloto Trasero

Rear Combination Lamp

Tipo: EUROPOINT II 24V



Función: Luz Posición - Freno - Intermitente -
Marcha Atrás - Antiniebla - Cuerno Balizamiento
Posición lateral - Luz Matrícula - Triángulo Reflectante
Opcional Módulo LED

Function: Dir.Indicator-, Stop-, Rear-, Fog-, Reverse-, End Outline
Marker-, Numberplate-, Sidemarket Lamp,
Triangle Reflex Reflector, Opt. LED Module

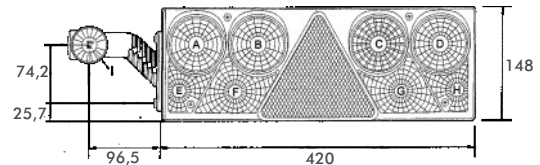

Referencia: Reference-No.	Ud. QTY	Izq. left	Dch. right	Luz Matrícula Numberplate- lamp	Descripción - Referencia O.E. Specification - O.E.-No.	Conector - Accesorios - Recambios Connector - Accessories - Spare Parts
A25-6011-511	1	■			O.E.: A25-6011-517 Conector 7p ASS2, cuerno Blanco/ rojo /ámbar 7p. ASS2 connector white/red/amber	
A25-6411-511	1		■		O.E.: A25-6411-517 Conector 7p ASS2, cuerno Blanco/ rojo /ámbar 7p. ASS2 connector white/red/amber	
A25-6015-501	1	■		■	O.E.: A25-6015-507 Conector 7p ASS2, cuerno Blanco/ negro /ámbar 7p. ASS2 connector white/black/amber	
A25-6415-501	1		■	■	O.E.: A25-6415-507 Conector 7p ASS2, cuerno Blanco/ negro /ámbar 7p. ASS2 connector white/black/amber	
A18-8560-002	2	■	■		kit 2 Tulipas Lens	
A31-3305-064	1	■			O.E.: A31-3305-074 Blanco/ rojo /ámbar	
A31-3306-064	1		■		O.E.: A31-3306-074 Blanco/ rojo /ámbar	
A31-3305-074	1	■			O.E.: A31-3305-064 Blanco/ negro /ámbar	
A31-3306-074	1		■		O.E.: A31-3306-064 Blanco/ negro /ámbar	
A13-5626-941	1	■			Conector amarillo, para las versiones Aspöck ASS1 & ASS2 Connector yellow, for Aspöck ASS1 & ASS2 connector system	
A13-5626-951	1		■		Conector verde, para las versiones Aspöck ASS1 & ASS2 Connector green, for Aspöck ASS1 & ASS2 connector system	

Piloto Trasero

Rear Combination Lamp

Tipo: EUROPOINT II 24V



Función: Luz Posición - Freno - Intermitente -
Marcha Atrás - Antiniebla - Cuerno Balizamiento
Posición lateral - Luz Matrícula - Triángulo Reflectante
Opcional Módulo LED

Function: Dir.Indicator-, Stop-, Rear-, Fog-, Reverse-, End Outline
Marker-, Numberplate-, Sidemarket Lamp,
Triangle Reflex Reflector, Opt. LED Module

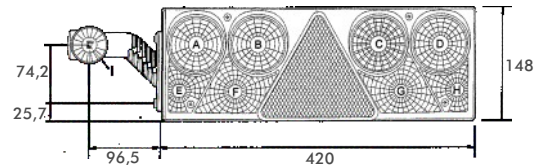

Referencia: Reference-No.	Ud. QTY	Izq. left	Dch. right	Luz Matrícula Numberplate- lamp	Descripción - Referencia O.E. Specification - O.E.-No.	Conector - Accesorios - Recambios Connector - Accessories - Spare Parts
A25-6110-501	1	■			O.E.: A25-6110-507 Con. 7p ASS2 + 2x2p ASS2, cuerno Blanco/rojo/ámbar 7p + 2x2 ASS2 connector whitte/red/ámbar	
A25-6510-501	1		■		O.E.: A25-6510-507 Conector 7p ASS2, cuerno Blanco/rojo/ámbar 7p + 2x2 ASS2 connector whitte/red/ámbar	
A25-6210-501	1	■			O.E.: A25-6210-507 Con. 7p ASS2 + 4x2p ASS2, cuerno Blanco/rojo/ámbar 7p + 4x2 ASS2 connector whitte/red/ámbar	
A25-6610-501	1		■		O.E.: A25-6610-507 Con. 7p ASS2 + 4x2p ASS2, cuerno Blanco/rojo/ámbar 7p + 4x2 ASS2 connector whitte/red/ámbar	
A25-6211-501	1	■		■	O.E.: A25-6211-507 Con. 7p ASS2 + 4x2p ASS2, cuerno Blanco/NEGRO/ámbar 7p + 4x2 ASS2 connector whitte/red/ámbar	
A25-6611-501	1		■	■	O.E.: A25-6611-507 Con. 7p ASS2 + 4x2p ASS2, cuerno Blanco/NEGRO/ámbar 7p + 4x2 ASS2 connector whitte/red/ámbar	
A25-6011-701	1	■			O.E.: A25-6011-707 Con. 7p ASS2, Posición y Freno LED, cuerno Blanco/rojo/ámbar 7p ASS2 connector, LED TAIL / STOP lamp, whitte/red/ámbar	
A25-6411-701	1		■		O.E.: A25-6411-707 Con. 7p ASS2, Posición y Freno LED, cuerno Blanco/rojo/ámbar 7p ASS2 connector, LED TAIL / STOP lamp, whitte/red/ámbar	
A31-3305-064	1	■			O.E.: A31-3305-074 Blanco/rojo/ámbar	
A31-3306-064	1		■		O.E.: A31-3306-074 Blanco/rojo/ámbar	

Piloto Trasero

Rear Combination Lamp



Tipo: EUROPOINT II 24V

Función: Luz Posición - Freno - Intermitente -
Marcha Atrás - Antiniebla - Cuerno Balizamiento LED
Posición lateral - Luz Matrícula - Triángulo Reflectante
Opcional Módulo LED

Function: Dir.Indicator-, Stop-, Rear-, Fog-, Reverse-, End Outline
Marker-, Numberplate-, Sidemarkers Lamp,
Triangle Reflex Reflector, Opt. LED Module

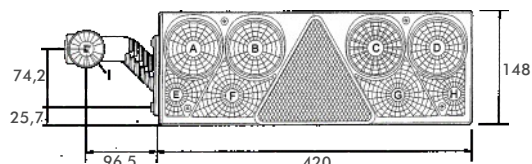

Referencia: Reference-No.	Ud. QTY	Izq. left	Dch. right	Luz Matrícula Numberplate- lamp	Descripción - Referencia O.E. Specification - O.E.-No.	Conector - Accesorios - Recambios Connector - Accessories - Spare Parts
A25-6021-701	1	■			O.E.: A25-6021-707 Conector 7p ASS2, cuerno LED Blanco/rojo/ámbar 7p ASS2 connector, LED End outline marker white/red/amber	
A25-6421-701	1		■		O.E.: A25-6421-707 Conector 7p ASS2, cuerno LED Blanco/rojo/ámbar 7p ASS2 connector, LED End outline marker white/red/amber	
A25-6110-711	1	■			O.E.: A25-6110-717 Conector 7p ASS2 +2x2p ASS2 cuerno LED Blanco/rojo/ámbar 7p +2x2p ASS2 conn., LED End outline marker white/red/amber	 Intermitente con módulo LED
A25-6510-711	1		■		O.E.: A25-6510-717 Conector 7p ASS2 +2x2p ASS2 cuerno LED Blanco/rojo/ámbar 7p +2x2p ASS2 conn., LED End outline marker white/red/amber	 Intermitente con módulo LED
A25-6021-741	1	■			O.E.: A25-6021-747 Conector 7p ASS2 cuerno LED Blanco/rojo/ámbar 7p ASS2 connector, LED End outline marker white/red/amber	 Posición y Freno con módulo LED
A25-6421-741	1		■		O.E.: A25-6421-747 Conector 7p ASS2 cuerno LED Blanco/rojo/ámbar 7p ASS2 connector, LED End outline marker white/red/amber	 Posición y Freno con módulo LED
A31-3305-084	1	■			O.E.: A31-3305-087 Blanco/rojo/ámbar	
A31-3306-084	1		■		O.E.: A31-3306-087 Blanco/rojo/ámbar	
A13-5626-941	1	■			Conector amarillo, para las versiones Aspöck ASS1 & ASS2 Connector yellow, for Aspöck ASS1 & ASS2 connector system	
A13-5626-951	1		■		Conector verde, para las versiones Aspöck ASS1 & ASS2 Connector green, for Aspöck ASS1 & ASS2 connector system	

Piloto Trasero

Rear Combination Lamp









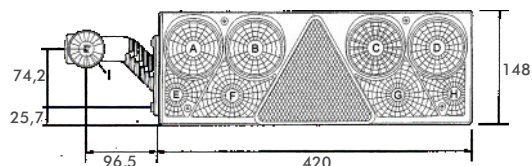

Tipo: EUROPOINT II 24V

Función: Luz Posición - Freno - Intermitente -
Marcha Atrás - Antiniebla - Cuerno Balizamiento LED
Posición lateral - Luz Matrícula - Triángulo Reflectante
Opcional Módulo LED

Function: Dir.Indicator-, Stop-, Rear-, Fog-, Reverse-, End Outline
Marker-, Numberplate-, Sidemarket Lamp,
Triangle Reflex Reflector, Opt. LED Module



Referencia: Reference-No.	Ud. QTY	Izq. left	Dch. right	Luz Matrícula Numberplate- lamp	Descripción - Referencia O.E. Specification - O.E.-No.	Conector - Accesorios - Recambios Connector - Accessories - Spare Parts
A25-6021-731	1	■			O.E.: A25-6021-737 Conector 7p ASS2, cuerno LED Blanco/rojo/ámbar 7p ASS2 connector, LED End outline marker white/red/amber	 Posición Freno e Intermitente con módulo LED
A25-6421-731	1		■		O.E.: A25-6421-737 Conector 7p ASS2, cuerno LED Blanco/rojo/ámbar 7p ASS2 connector, LED End outline marker white/red/amber	 Posición Freno e Intermitente con módulo LED
A25-6020-751	1	■			O.E.: A25-6020-757 Conector 7p ASS2 cuerno LED Blanco/rojo/ámbar 7p ASS2 connector, LED End outline marker white/red/amber	 Completo LED
A25-6420-751	1		■		O.E.: A25-6420-757 Conector 7p ASS2 cuerno LED Blanco/rojo/ámbar 7p connector, LED End outline marker white/red/amber	 Completo LED
A18-8560-002	2	■	■		Kit 2 tulipas Lens	
A31-3305-084		■			O.E.: A31-3305-087 Blanco/rojo/ámbar	
A31-3306-084	1		■		O.E.: A31-3306-087 Blanco/rojo/ámbar	
A13-5626-941	1	■			Conector amarillo, para las versiones Aspöck ASS1 & ASS2 Connector yellow, for Aspöck ASS1 & ASS2 connector system	
A13-5626-951	1		■		Conector verde, para las versiones Aspöck ASS1 & ASS2 Connector green, for Aspöck ASS1 & ASS2 connector system	

Piloto Trasero

Rear Combination Lamp

Tipo: Módulos LED para EUROPOINT II

Función: Intermitente LED-, Frenos LED-, Posición LED-, Antiniebla Led-, Marcha Atrás LED

Function: LED Dir.Indicator-, LED Stop-, LED Rear-, LED Fog-, LED Reverse Lamp



Referencia: Reference-No.	Ud. QTY	Izq. left	Dch. right	Luz Matrícula Numberplate- lamp	Descripción - Referencia O.E. Specification - O.E.-No.	Conector - Accesorios - Recambios Connector - Accessories - Spare Parts
A12-1560-001	1	■	■		O.E.: A12-1560-007 Función: Posición LED LED-Unit Rear Lamp	
A12-1560-011	1	■	■		O.E.: A12-1560-017 Función: Intermitente LED LED-Unit Direction Indicator Lamp	
A12-1560-141	1	■	■		O.E.: A12-1560-047 Función: Freno LED LED-Unit Stop Lamp	
A12-1560-031	1	■	■		O.E.: A12-1560-037 Función: Antiniebla LED LED-Unit Fog Lamp	
A12-1560-021	2	■	■		O.E.: A12-1560-027 Función: Marcha Atrás LED LED-Unit Reverse Lamp	
A75-0300-001	1	■	■		O.E.: A75-0300-007 Controlador LED 24V conector ASS2,para las funciones de Freno - Posición - Intermitente LED Control Gear, Aspöck ASS2 for Stop-Tail-Dir.Indicator function	
A15-5276-004	1	■	■		O.E.: A15-5276-007 Tapa protectora trasera grande para los pilotos Europoint I/II/III Big Protection cap Europoint II/III	
A15-5270-004	1	■	■		O.E.: A15-5270-007 Tapa protectora trasera pequeña para los pilotos Europoint I/II/III Big Protection cap Europoint II/III	

Piloto Trasero

Rear Combination Lamp

Tipo: EUROPOINT 24V



Función: Luz Posición - Freno - Intermitente -
 Marcha Atrás - Antiniebla - Balizamiento
 Posición lateral - Luz Matrícula - Triángulo Reflectante

Function: Dir.Indicator-, Stop-, Rear-, Fog-, Reverse-, End Outline
 Marker-, Numberplate-, Sidemarkers Lamp,
 Triangle Reflex Reflector

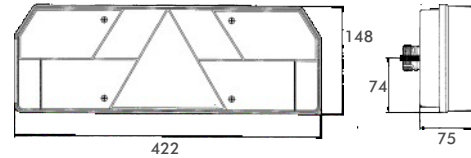

Referencia: Reference-No.	Ud. QTY	Izq. left	Dch. right	Luz Matrícula Numberplate- lamp	Descripción - Referencia O.E. Specification - O.E.-No.	Conector - Accesorios - Recambios Connector - Accessories - Spare Parts
S25-5101-521	1	■		■	Versión prensa estopa Con bombillas incluidas version grommet, with bulbs fitted	
S25-5501-521	1		■	■	Versión prensa estopa Con bombillas incluidas version grommet, with bulbs fitted	
A25-5001-501	1	■		■	O.E.: A25-5001-507 Conector 7p ASS2 Con bombillas incluidas 7p ASS2 connector, with bulbs fitted	
A25-5401-501	1		■	■	O.E.: A25-5401-507 Conector 7p ASS2 Con bombillas incluidas 7p ASS2 connector, with bulbs fitted	
A18-8550-002	2	■	■		Kit 2 Tulipas Lens	
A13-5626-164/1	1	■			Conector amarillo 7p ASS2 Connector yellow, ASS2 7 poles	
A13-5626-174/1			■		Conector verde 7p ASS2 Connector yellow, ASS2 7 poles	
A12-3922-004	1	■	■		Avisador acústico para colocar en el interior del piloto Back Alarm System to fit into the Rear Lamp Housing	

Piloto Trasero

Rear Combination Lamp



Tipo: EUROPOINT 24V

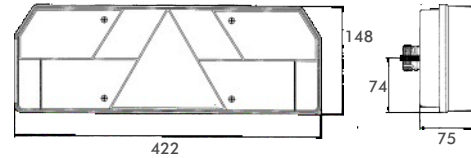

Función: Luz Posición - Freno - Intermitente -
 Marcha Atrás - Antiniebla - Balizamiento
 Posición lateral - Luz Matrícula - Triángulo Reflectante

Function: Dir.Indicator-, Stop-, Rear-, Fog-, Reverse-, End Outline
 Marker-, Numberplate-, Sidemarket Lamp,
 Triangle Reflex Reflector

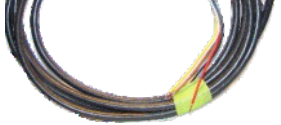

Referencia: Reference-No.	Ud. QTY	Izq. left	Dch. right	Luz Matrícula Numberplate- lamp	Descripción - Referencia O.E. Specification - O.E.-No.	Conector - Accesorios - Recambios Connector - Accessories - Spare Parts
A35-5103-227	1	■		■	Versión con cable 2.5m y bombillas incluidas Cable 2,5m + with bulbs fitted	
A35-5502-007	1		■	■	Versión con cable 2.5m y bombillas incluidas Cable 2,5m + with bulbs fitted	
A18-8550-002		■	■		Kit 2 Tulipas Lens	
A12-3922-004	1	■	■		Avisador acústico para colocar en el interior del piloto Back Alarm System to fit into the Rear Lamp Housing	

Piloto Trasero

Rear Combination Lamp



Tipo: ECOPOINT 24V

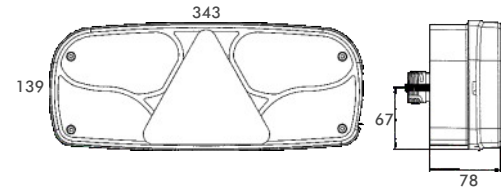

Función: Luz Posición - Freno - Intermitente -
 Marcha Atrás - Antiniebla - Luz Matrícula - Triángulo
 Reflectante
 Opcional Módulo LED

Function: Dir.Indicator-, Stop-, Rear-, Fog-, Reverse-,
 Numberplate Lamp, Triangle Reflex Reflector,
 Opt. LED Module



Referencia: Reference-No.	Ud. QTY	Izq. left	Dch. right	Luz Matrícula Numberplate- lamp	Descripción - Referencia O.E. Specification - O.E.-No.	Conector - Accesorios - Recambios Connector - Accessories - Spare Parts
A25-2200-001	1	■			O.E.: A25-2200-007 Conector 7p ASS2 Con bombillas incluidas 7p ASS2 connector, with bulbs fitted	
A25-2600-001	1		■		O.E.: A25-2600-007 Conector 7p ASS2 Con bombillas incluidas 7p ASS2 connector, with bulbs fitted	
A25-2201-001	1	■		■	O.E.: A25-2201-007 Conector 7p ASS2 Con bombillas incluidas 7p ASS2 connector, with bulbs fitted	
A25-2601-001	1		■	■	O.E.: A25-2601-007 Conector 7p ASS2 Con bombillas incluidas 7p ASS2 connector, with bulbs fitted	
A18-8522-002	2	■	■		Kit 2 Tulipas Lens	
A13-5626-941	1	■			Conector amarillo, para las versiones Aspöck ASS1 & ASS2 Connector yellow, for Aspöck ASS1 & ASS2 connector system	
A13-5626-951	1		■		Conector verde, para las versiones Aspöck ASS1 & ASS2 Connector green, for Aspöck ASS1 & ASS2 connector system	

Piloto Trasero

Rear Combination Lamp







Tipo: ECOPOINT 24V

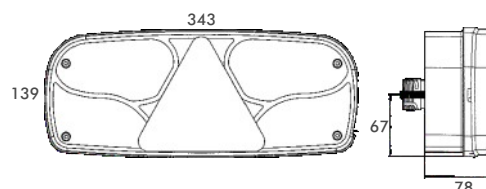

Función: Luz Posición - Freno - Intermitente -
 Marcha Atrás - Antiniebla - Luz Matrícula - Triángulo
 Reflectante
 Opcional Módulo LED

Function: Dir.Indicator-, Stop-, Rear-, Fog-, Reverse-,
 Numberplate Lamp, Triangle Reflex Reflector,
 Opt. LED Module



Referencia: Reference-No.	Ud. QTY	Izq. left	Dch. right	Luz Matrícula Numberplate- lamp	Descripción - Referencia O.E. Specification - O.E.-No.	Conector - Accesorios - Recambios Connector - Accessories - Spare Parts
A25-2201-701	1	■		■	O.E.: A25-2201-707 Conector 7p ASS2 Con bombillas incluidas 7p ASS2 connector, with bulbs fitted	 Posición y Freno con Módulo LED
A25-2601-701	1		■	■	O.E.: A25-2601-707 Conector 7p ASS2 Con bombillas incluidas 7p ASS2 connector, with bulbs fitted	 Posición y Freno con Módulo LED
A25-2201-731	1	■		■	O.E.: A25-2201-737 Conector 7p ASS2 Con bombillas incluidas 7p ASS2 connector, with bulbs fitted	 Completo LED
A25-2601-731	1		■	■	O.E.: A25-2601-737 Conector 7p ASS2 Con bombillas incluidas 7p ASS2 connector, with bulbs fitted	 Completo LED
A18-8522-002	2	■	■		Kit 2 Tulipas Lens	
A13-5626-941	1	■			Conector amarillo, para las versiones Aspöck ASS1 & ASS2 Connector yellow, for Aspöck ASS1 & ASS2 connector system	
A13-5626-951	1		■		Conector verde, para las versiones Aspöck ASS1 & ASS2 Connector green, for Aspöck ASS1 & ASS2 connector system	

Piloto Trasero

Rear Combination Lamp

Tipo: ECOPOINT 24V

Función: Luz Posición - Freno - Intermitente -
 Marcha Atrás - Antiniebla - Luz Matrícula - Cuerno
 Balizamiento Posición - Triángulo Reflectante
 Opcional Módulo LED

Function: Dir.Indicator-, Stop-, Rear-, Fog-, Reverse-, End Outline
 Marker-, Numberplate Lamp, Triangle Reflex Reflector,
 Opt. LED Module

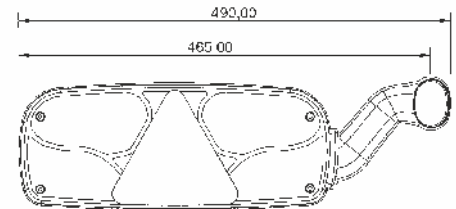

Referencia: Reference-No.	Ud. QTY	Izq. left	Dch. right	Luz Matrícula Numberplate- lamp	Descripción - Referencia O.E. Specification - O.E.-No.	Conector - Accesorios - Recambios Connector - Accessories - Spare Parts
A25-2210-001	1	■			O.E.: A25-2210-007 Conector 7p ASS2 Con Bombillas incluidas 7p ASS2 connector with bulbs fitted	
A25-2610-001	1		■		O.E.: A25-2610-007 Conector 7p ASS2 Con Bombillas incluidas 7p ASS2 connector with bulbs fitted	
A25-2211-001	1	■		■	O.E.: A25-2211-007 Conector 7p ASS2 Con Bombillas incluidas 7p ASS2 connector with bulbs fitted	
A25-2611-001	1		■	■	O.E.: A25-2611-007 Conector 7p ASS2 Con Bombillas incluidas 7p ASS2 connector with bulbs fitted	
A18-8522-002	2	■	■		Kit 2 Tulipas Lens	
A13-5626-941	1	■			Conector amarillo, para las versiones Aspöck ASS1 & ASS2 Connector yellow, for Aspöck ASS1 & ASS2 connector system	
A13-5626-951	1		■		Conector verde, para las versiones Aspöck ASS1 & ASS2 Connector green, for Aspöck ASS1 & ASS2 connector system	

Piloto Trasero

Rear Combination Lamp

Tipo: ECOPOINT 24V

Función: Luz Posición - Freno - Intermitente -
Marcha Atrás - Antiniebla - Luz Matrícula - Cuerno
Balizamiento Posición - Triángulo Reflectante
Opcional Módulo LED

Function: Dir.Indicator-, Stop-, Rear-, Fog-, Reverse-, End Outline
Marker-, Numberplate Lamp, Triangle Reflex Reflector,
Opt. LED Module

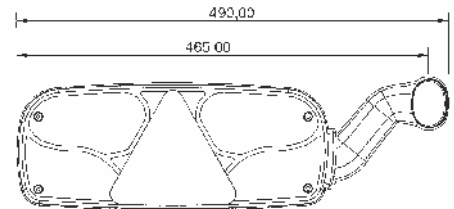

Referencia: Reference-No.	Ud. QTY	Izq. left	Dch. right	Luz Matrícula Numberplate- lamp	Descripción - Referencia O.E. Specification - O.E.-No.	Conector - Accesorios - Recambios Connector - Accessories - Spare Parts
A25-2211-701	1	■		■	O.E.: A25-2211-707 Conector 7p ASS2 Con Bombillas incluidas 7p ASS2 connector with bulbs fitted	 Posición y Freno con Módulo LED
A25-2611-701	1		■	■	O.E.: A25-2611-707 Conector 7p ASS2 Con Bombillas incluidas 7p ASS2 connector with bulbs fitted	 Posición y Freno con Módulo LED
A25-2211-711	1	■		■	O.E.: A25-2211-717 Conector 7p ASS2 Con Bombillas incluidas 7p ASS2 connector with bulbs fitted	 Posición / Freno / Intermitente con Módulo LED
A25-2611-711	1		■	■	O.E.: A25-2611-717 Conector 7p ASS2 Con Bombillas incluidas 7p ASS2 connector with bulbs fitted	 Posición / Freno / Intermitente con Módulo LED
A25-2211-721	1	■		■	O.E.: A25-2211-727 Conector 7p ASS2 Con Bombillas incluidas 7p ASS2 connector with bulbs fitted	 Posición / Freno / Intermitente / Niebla con Módulo LED
A25-2611-721	1		■	■	O.E.: A25-2611-727 Conector 7p ASS2 Con Bombillas incluidas 7p ASS2 connector with bulbs fitted	 Posición / Freno / Intermitente / Niebla con Módulo LED
A25-2211-731	1	■		■	O.E.: A25-2211-737 Conector 7p ASS2 Cuerno de Bombilla 7p ASS2 connector with bulbs fitted	 Completo LED
A25-2611-731	1		■	■	O.E.: A25-2611-737 Conector 7p ASS2 Cuerno de Bombilla 7p ASS2 connector with bulbs fitted	 Completo LED

Piloto Trasero

Rear Combination Lamp

Tipo: Módulos LED para ECOPOINT

Función: Intermitente LED-, Frenos LED-, Posición LED-,
Antiniebla LED-,
Marcha Atrás LED

Function: LED Dir.Indicator-, LED Stop-, LED Rear-, LED Fog-,
LED Reverse Lamp



Referencia: Part-No.	Ud. QTY	Izq. left	Dch. right	Luz Matrícula Numberplate- lamp	Descripción - Referencia O.E. Specification - O.E.-No.	Conector - Accesorios - Recambios Connector - Accessories - Spare Parts
A12-1522-004	1		■		O.E.: A12-1522-007 Posición / Freno LED LED-Unit Stop-Rear Lamp	
A12-1526-004	1		■		O.E.: A12-1526-007 Posición / Freno LED LED-Unit Stop-Rear Lamp	
A12-1522-014	1		■		O.E.: A12-1522-017 Intermitente LED LED-Unit Direction Indicator Lamp	
A12-1526-014	1		■		O.E.: A12-1526-017 Intermitente LED LED-Unit Direction Indicator Lamp	
A12-1522-024	1		■		O.E.: A12-1522-027 Antiniebla LED LED-Unit Fog Lamp	
A12-1526-024	1		■		O.E.: A12-1526-027 Antiniebla LED LED-Unit Fog Lamp	
A12-1522-034	1		■		O.E.: A12-1522-037 Marcha Atrás LED LED-Unit Reverse Lamp	
A12-1526-034	1		■		O.E.: A12-1526-037 Marcha Atrás LED LED-Unit Reverse Lamp	
A75-0300-001	1		■	■	Controlador LED 24V con conector Aspöck ASS2, para las funciones de Freno - Posición - Intermitente LED Control Gear, Aspöck ASS2 for Stop-Tail-Dir.Indicator function	

Piloto Trasero

Rear Combination Lamp



Tipo: Accesorios para ECOPOINT

Función: Cuerno balizamiento



Function: End Outline Marker



Referencia: Part-No.	Ud. QTY	Izq. left	Dch. right	Luz Matrícula Numberplate- lamp	Descripción - Referencia O.E. Specification - O.E.-No.	Conector - Accesorios - Recambios Connector - Accessories - Spare Parts
A31-3608-014	1		■		O.E.: A31-3608-017 Cuerno Superpoint II Ecopoint rojo/blanco/ámbar End outline marker Superpoint II Ecopoint red/white/amber	
A31-3608-004	1			■	O.E.: A31-3608-007 Cuerno Superpoint II Ecopoint rojo/blanco/ámbar End outline marker Superpoint II Ecopoint red/white/amber	
A31-3305-174	1		■		O.E.: A31-3305-177 Cuerno Superpoint II LED Ecopoint rojo/blanco/ámbar LED End outline marker Superpoint II Ecopoint red/white/ amber	
A31-3306-174	1			■	O.E.: A31-3306-177 Cuerno Superpoint II LED Ecopoint rojo/blanco/ámbar LED End outline marker Superpoint II Ecopoint red/white/ amber	
A18-8136-007	1				Tulipa Policarbonato, roja/blanca/ámbar Lens with integrated sidemarker lamp made in PC	 A18-8136-007
A15-5276-004	1		■		Tapa protectora trasera grande para los pilotos ECOPOINTI Big Protection cap Ecopoint	
A15-5270-004	1			■	Tapa protectora trasera pequeña para los pilotos ECOPOINT Big Protection cap Ecopoint	

Piloto Trasero

Rear Combination Lamp



Tipo: 7 Funciones KRONE / SCHMITZ

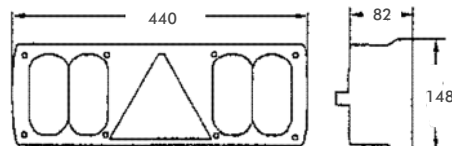

Función: Luz Posición - Freno - Intermitente -
 Marcha Atrás - Antiniebla - Luz Matrícula -
 Balizamiento lateral - Triángulo
 Reflectante

Function: Dir.Indicator-, Stop-, Rear-, Fog-, Reverse-, End Outline
 Marker-, Sidemarker Lamp, Triangle Reflex Reflector



Referencia: Reference-No.	Ud. QTY	Izq. left	Dch. right	Luz Matrícula Numberplate- lamp	Descripción - Referencia O.E. Specification - O.E.-No.	Conector - Accesorios - Recambios Connector - Accessories - Spare Parts
P40.242.011	1	■				
P40.242.012	1		■			
P40.242.611	1	■				
P40.242.612	1		■			
P40.242.112	1	■	■		Tulipa Lens	

Piloto Trasero



Rear Combination Lamp

Tipo: 5 Funciones KÖGEL

Función: Luz Posición Led- Freno - Intermitente -
Marcha Atrás - Antiniebla - Luz Matrícula - Cuerno
Balizamiento - Triángulo Reflectante

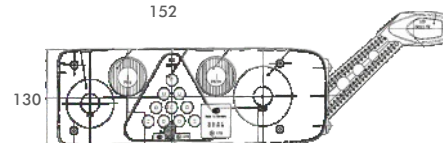
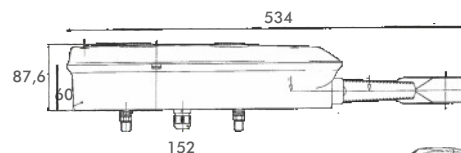
Function: LED Tail Lamp, Dir.Indicator-, Stop-, Fog-, Reverse-, End
Outline Marker-, Sidemarker Lamp,
Triangle Reflex Reflector



Referencia: Reference-No.	Ud. QTY	Izq. left	Dch. right	Luz Matrícula Numberplate- lamp	Descripción - Referencia O.E. Specification - O.E.-No.	Conector - Accesorios - Recambios Connector - Accessories - Spare Parts
P40.275.411	1	■			KÖGEL 6604332	
P40.275.412	1		■		KÖGEL 6604331	
P40.275.111	1	■			Tulipa Lens	
P40.275.112	1		■		Tulipa Lens	

Piloto Trasero

Rear Combination Lamp

Tipo: 5 Funciones Triángulo Translúcido

Función: Luz Posición - Freno - Intermitente -
Marcha Atrás - Antiniebla - Luz Matrícula -
Balizamiento lateral - Triángulo
Reflectante

Function: Dir.Indicator-, Stop-, Rear-, Fog-, Reverse-,
Sidemarker Lamp, Triangle Reflex Reflector

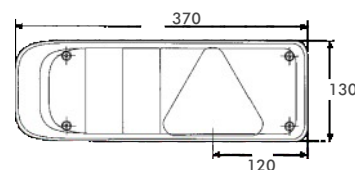
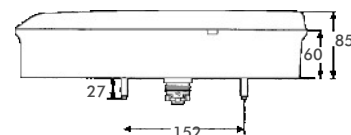

Referencia: Reference-No.	Ud. QTY	Izq. left	Dch. right	Luz Matrícula Numberplate- lamp	Descripción - Referencia O.E. Specification - O.E.-No.	Conector - Accesorios - Recambios Connector - Accessories - Spare Parts
P40.256.011/2	1	■			Con balizamiento lateral y Triángulo Translúcido Without sidemarker lamp translucent triangle	
P40.256.012/2	1		■		Con balizamiento lateral y Triángulo Translúcido Without sidemarker lamp translucent triangle	
P40.256.013/2	1	■		■	Con balizamiento lateral y Triángulo Translúcido Without sidemarker lamp translucent triangle	
P40.256.014/2	1		■	■	Con balizamiento lateral y Triángulo Translúcido Without sidemarker lamp translucent triangle	
J80093023	1	■		■	Versión con conector AMP 7p Version 7p AMP connector	
J80093024	1		■	■	Versión con conector AMP 7p Version 7p AMP connector	
P40.256.111/2	1	■			Tulipa triángulo Translúcido Translucent triangle Lens	
P40.256.112/2	1		■		Tulipa triángulo Translúcido Translucent triangle Lens	

Piloto Trasero







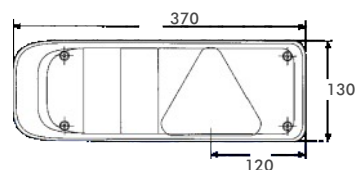
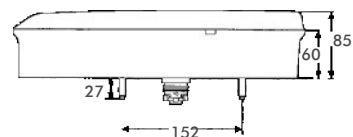

Rear Combination Lamp

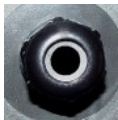
Tipo: 5 Funciones

Función: Luz Posición - Freno - Intermitente -
 Marcha Atrás - Antiniebla - Luz Matricula -
 Balizamiento lateral - Triángulo
 Reflectante

Function: Dir.Indicator-, Stop-, Rear-, Fog-, Reverse-,
 Sidemarker Lamp, Triangle Reflex Reflector



Referencia: Reference-No.	Ud. QTY	Izq. left	Dch. right	Luz Matrícula Numberplate- lamp	Descripción - Referencia O.E. Specification - O.E.-No.	Conector - Accesorios - Recambios Connector - Accessories - Spare Parts
P40.256.011/1	1	■			Sin balizamiento lateral Without sidemarker lamp	
P40.256.012/1	1		■		Sin balizamiento lateral Without sidemarker lamp	
P40.256.013/1	1	■		■	Sin balizamiento lateral Without sidemarker lamp	
P40.256.014/1	1		■	■	Sin balizamiento lateral Without sidemarker lamp	
P40.256.311	1	■			Con conector 7p 7p connector	
P40.256.312	1		■		Con conector 7p 7p connector	
P40.256.111/1	1	■			Tulipa Lens	
P40.256.112/1	1		■		Tulipa Lens	

Piloto Trasero

Rear Combination Lamp









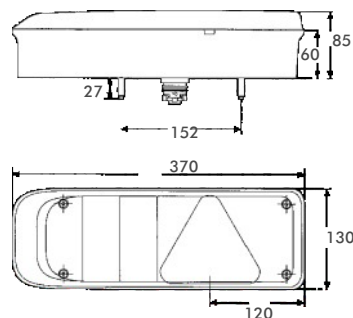

Tipo: 5 Funciones KRONE



Función: Luz Posición - Freno - Intermitente -
 Marcha Atrás - Antiniebla - Luz Matrícula -
 Cuerno Balizamiento lateral - Triángulo
 Reflectante

Function: Dir.Indicator-, Stop-, Rear-, Fog-, Reverse-, End Outline
 Marker-, Sidemarker Lamp, Triangle Reflex Reflector



Referencia: Reference-No.	Ud. QTY	Izq. left	Dch. right	Luz Matrícula Numberplate- lamp	Descripción - Referencia O.E. Specification - O.E.-No.	Conector - Accesorios - Recambios Connector - Accessories - Spare Parts
P40.256.211	1	■				
P40.256.212	1		■			
P40.256.411	1	■				
P40.256.412	1		■			
P40.256.111/1	1	■			Tulipa Lens	
P40.256.112/1	1		■		Tulipa Lens	
P40.137.504	1	■			Cuerno Balizamiento LED con Cable 0.5m+conector EasyCon, tulipa transparente End Outline Marker Lamp cable 0,5m + EasyCon Connector	
P40.137.514	1		■		Cuerno Balizamiento LED con Cable 0.5m+conector EasyCon, tulipa transparente End Outline Marker Lamp cable 0,5m + EasyCon Connector	
P40.137.504/1	1	■			Cuerno Balizamiento LED con Cable 0.5m End Outline Marker Lamp cable 0,5m	
P40.137.514/1	1		■		Cuerno Balizamiento LED con Cable 0.5m End Outline Marker Lamp cable 0,5m	

Piloto trasero

Rear Combination Lamp

Tipo: LC5TDX

Función: Luz Posición - Freno - Intermitente -
Marcha Atrás - Antiniebla - Luz Matrícula - Posición -
Triángulo Reflectante

Function: Dir.Indicator-, Stop-, Rear-, Fog-, Reverse-,
Numberplate Lamp, Triangle Reflex Reflector

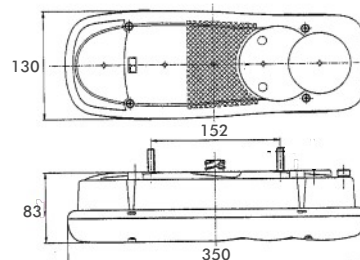

Referencia: Reference-No.	Ud. QTY	Izq. left	Dch. right	Luz Matrícula Numberplate- lamp	Descripción - Referencia O.E. Specification - O.E.-No.	Conector - Accesorios - Recambios Connector - Accessories - Spare Parts
P40.267.013	1	■		■	115011000016	
P40.267.014	1		■	■	115011000017	
P40.267.111	1	■			115015100026 Tulipa Lens	
P40.267.112	1		■		115015100025 Tulipa Lens	

Piloto Trasero

Rear Combination Lamp

Tipo: 7 Funciones LC8

Función: Luz Posición - Freno - Intermitente -
 Marcha Atrás - Antiniebla - Luz Matrícula -
 Balizamiento lateral - Triángulo
 Reflectante

Function: Dir.Indicator-, Stop-, Rear-, Fog-, Reverse-, End Outline
 Marker-, Numberplate-, Sidemarkers Lamp red,
 Triangle Reflex Reflector

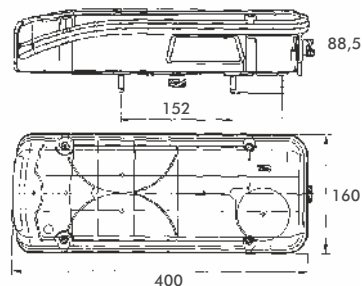

Referencia: Reference-No.	Ud. QTY	Izq. left	Dch. right	Luz Matrícula Numberplate- lamp	Descripción - Referencia O.E. Specification - O.E.-No.	Conector - Accesorios - Recambios Connector - Accessories - Spare Parts
P40.253.211	1	■				
P40.253.212	1		■			
P40.253.213	1	■		■		
P40.253.214	1		■	■		
P40.253.121	1	■			Tulipa Lens	
P40.253.122	1		■		Tulipa Lens	
P50.071.100	1	■	■		Kit Conector AMP Repairkit	
P50.120.000	2	■	■		Kit Conector AMP con 4m de Cable Cablekit with AMP connector, 4m	

Piloto trasero





Rear Combination Lamp

TIPO: 7 Funciones Leciñena

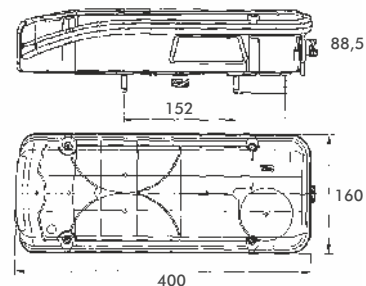
Función: Luz Posición - Freno - Intermitente -
Marcha Atrás - Antiniebla - Luz Matrícula - Posición -
Triángulo Reflectante

Function: Dir.Indicator-, Stop-, Rear-, Fog-, Reverse-,
Numberplate Lamp, Triangle Reflex Reflector



Referencia: Reference-No.	Ud. QTY	Izqdo. left	Dcho. right	Luz Matrícula Numberplate- lamp	Descripción - O.E. Number Specification - O.E.-No.	Conector - Accesorios - Recambios Connector - Accessories - Spare Parts
P40.253.213/1	1	■		■		
P40.253.214/1	1		■	■		
P40.253.121/1	1	■			Tulipa Blanca White Lens	
P40.253.122/1	1		■		Tulipa Blanca White Lens	
P50.071.100	1	■	■			

Piloto trasero





Rear Combination Lamp

TIPO: 7 Funciones Leciñena

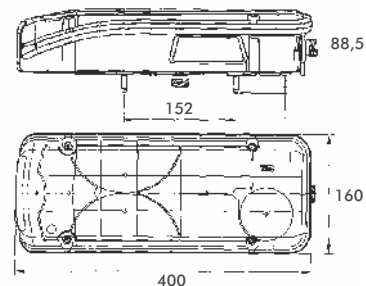
Función: Luz Posición - Freno - Intermitente -
Marcha Atrás - Antiniebla - Luz Matrícula - Posición -
Triángulo Reflectante

Function: Dir.Indicator-, Stop-, Rear-, Fog-, Reverse-,
Numberplate Lamp, Triangle Reflex Reflector



Referencia: Reference-No.	Ud. QTY	Izqdo. left	Dcho. right	Luz Matrícula Numberplate- lamp	Descripción - O.E. Number Specification - O.E.-No.	Conector - Accesorios - Recambios Connector - Accessories - Spare Parts
P40.253.213/1	1	■		■		
P40.253.214/1	1		■	■		
P40.253.121/1	1	■			Tulipa Blanca White Lens	
P40.253.122/1	1		■		Tulipa Blanca White Lens	
P50.071.100	1	■	■			

Piloto trasero





Rear Combination Lamp

Tipo: 7-Funciones

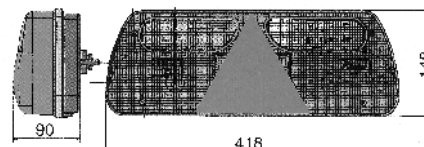
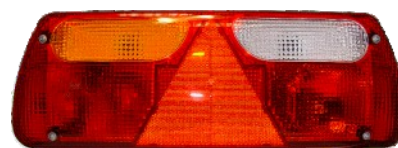
Función: Luz Posición - Freno - Intermitente -
Marcha Atrás - Antiniebla - Posición -
Triángulo Reflectante

Function: Dir.Indicator-, Stop-, Rear-, Fog-, Reverse-, End Outline
Marker-, Sidemarker Lamp, Triangle Reflex Reflector



Referencia: Reference-No.	Ud. QTY	Izqdo. left	Dcho. right	Luz Matrícula Numberplate- lamp	Descripción - O.E. Number Specification - O.E.-No.	Conector - Accesorios - Recambios Connector - Accessories - Spare Parts
P40.245.011	1	■				
P40.245.012	1		■			
P40.245.111	1	■			Tulipa Lens	
P40.245.112	1		■		Tulipa Lens	

Piloto trasero



Rear Combination Lamp

Tipo: 5-Funciones

Función: Luz Posición, Freno, Intermitente, Antiniebla,
Marcha Atrás, Triángulo Reflectante

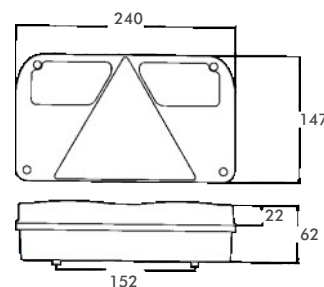
Function: Dir.Indicator-, Stop-, Rear-, Fog-, Reverse-,
Numberplate Lamp, Triangle Reflex Reflector



Referencia: Reference-No.	Ud. QTY	Izq. left	Dch. right	Luz Matrícula Numberplate- lamp	Anti- Niebla Fog- lamp	Marcha Atrás Reversing lamp	Descripción Referencia O.E. Specification - O.E.-No.	Conector - Accesorios Connector - Spare Parts
P40.268.011	1	■			■	■	Piloto completo fabricado en Policarbonato Complete lamp made of unbreakable Polycarbonate	
P40.268.012	1		■		■	■	Piloto completo fabricado en Policarbonato Complete lamp made of unbreakable Polycarbonate	
P40.268.111	1	■			■	■	Tulipa Lens	
P40.268.112	1		■		■	■	Tulipa Lens	

Piloto trasero LED

LED Rear Combination Lamp

Tipo: MULTIPOINT LED

Función: Luz Posición LED, Freno LEDt, Intermitente, Antiniebla, Marcha Atrás, Triángulo Reflectante

Function: LED Rear Lamp, LED Stop Lamp, Dir.Indicator-, Fog-, Reverse Lamp, Triangle Reflex Reflector

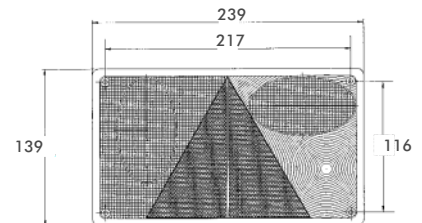

Referencia: Reference-No.	Ud. QTY	Izq. left	Dch. right	Luz Matrícula Numberplate- lamp	Anti- Niebla Fog- lamp	Marcha Atrás Reversing lamp	Descripción Referencia O.E. Specification - O.E.-No.	Conector - Accesorios Connector - Spare Parts
A34-5802-001	1		■			■	34-5802-007 Cable 1,8m conector recto Cable 1,8m	
A34-5705-001	1	■			■		34-5705-007 Cable 2,5m conector codo 90° Cable 2,5m	
A34-5806-001	1		■			■	34-5806-007 Cable 2,5m conector codo 90° Cable 2,5m	
A18-8457-137	1	■					Tulipa Lens	
A18-8458-137	1		■				Tulipa Lens	
A12-1527-004	1	■	■				Módulo LED para Freno/Posición LED Module for Stop-Rear Lamp	

Piloto trasero

Rear Combination Lamp

Tipo: MULTIPOINT V

Función: Luz Posición, Freno, Intermitente, Antiniebla, Marcha Atrás, Triángulo Reflectante

Function: Dir.Indicator-, Stop-, Rear-, Fog-, Reverse-, Numberplate Lamp, Triangle Reflex Reflector

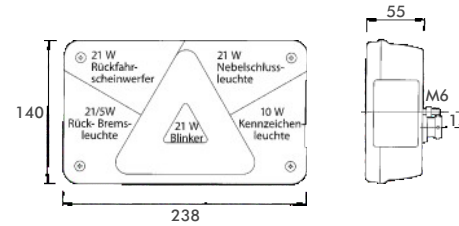

Referencia: Reference-No.	Ud. QTY	Izq. left	Dch. right	Luz Matrícula Numberplate- lamp	Anti- Niebla Fog- lamp	Marcha Atrás Reversing lamp	Descripción Referencia O.E. Specification - O.E.-No.	Conector - Accesorios Connector - Spare Parts
A24-8500-007	1	■		■ lateral/ lateral	■		Con Bombillas 12V incluidas Bulbs 12V fitted	
A24-8700-007	1		■	■ lateral/ lateral			Con Bombillas 12V incluidas Bulbs 12V fitted	
A24-8710-007	1		■	■ lateral/ lateral		■	Con Bombillas 12V incluidas Bulbs 12V fitted	
A18-8485-007	1	■					Tulipa Lens	
A18-8487-007	1		■				Tulipa Lens	
A13-0546-004	1	■	■				Kit conector Repairkit	

Piloto trasero

Rear Combination Lamp



Tipo: MULTIPOINT V LED

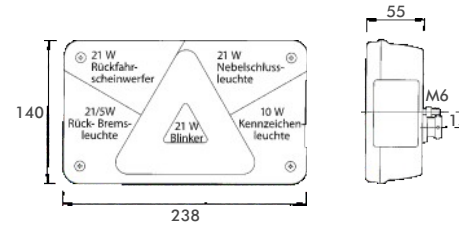

Función: Luz Posición LED, Freno LEDt, Intermitente, Antiniebla, Marcha Atrás, Triángulo Reflectante

Function: LED Rear Lamp, LED Stop Lamp, Dir.Indicator-, Fog-, Reverse Lamp, Triangle Reflex Reflector



Referencia: Reference-No.	Ud. QTY	Izq. left	Dch. right	Luz Matrícula Numberplate- lamp	Anti- Niebla Fog- lamp	Marcha Atrás Reversing lamp	Descripción Referencia O.E. Specification - O.E.-No.	Conector - Accesorios Connector - Spare Parts
F25-8504-707	1	■		■ lateral/ lateral	■		Versión con cable 3m y conector.. 24V version cable 3 m. 24V	
F25-8714-707	1		■	■ lateral/ lateral		■	Versión con cable 3m y conector.. 24V version cable 3 m. 24V	
A18-8485-007	1	■					Tulipa Lens	
A18-8487-007	1		■				Tulipa Lens	
A12-1530-004	1	■					Módulo LED Posición y Freno LED Unit Tail Lamp Stop Lamp	
A12-1531-004	1	■	■				Módulo LED Posición y Freno LED Unit Tail Lamp Stop Lamp	

Piloto trasero

Rear Combination Lamp

Tipo: MULTIPOINT IV



Función: Luz Posición, Freno, Intermitente, Antiniebla, Marcha
 Atrás, Triángulo Reflectante

Function: Dir.Indicator-, Stop-, Rear-, Fog-, Reverse-,
 Numberplate Lamp, Triangle Reflex Reflector

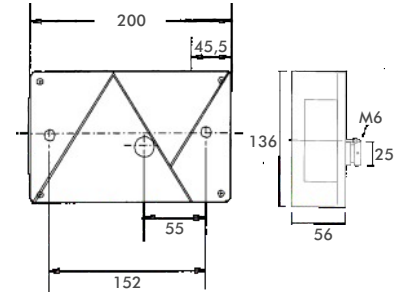

Referencia: Reference-No.	Ud. QTY	Izq. left	Dch. right	Luz Matrícula Numberplate- lamp	Anti- Niebla Fog- lamp	Marcha Atrás Reversing lamp	Descripción Referencia O.E. Specification - O.E.-No.	Conector - Accesorios Connector - Spare Parts
A24-8400-007	1	■		■ lateral/ lateral	■		Con bombillas 12V incluidas Bulbs 12V fitted	
A24-8600-007	1		■	■ lateral/ lateral			Con bombillas 12V incluidas Bulbs 12V fitted	
A24-8610-007	1		■	■ lateral/ lateral		■	Con bombillas 12V incluidas Bulbs 12V fitted	
A18-8484-007	1	■					Tulipa Lens	
A18-8486-007	1		■				Tulipa Lens	
A13-0546-004	1	■	■				Kit Conector Repairkit	

Piloto trasero





Rear Combination Lamp

Tipo: MULTIPOINT III

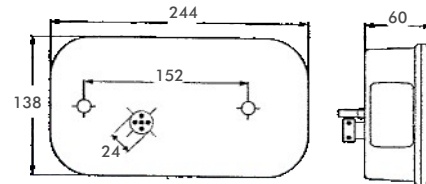
Función: Luz Posición, Freno, Intermitente, Antiniebla, Marcha Atrás, Triángulo Reflectante

Function: Dir.Indicator-, Stop-, Rear-, Fog-, Reverse-, Numberplate Lamp, Triangle Reflex Reflector



Referencia: Reference-No.	Ud. QTY	Izq. left	Dch. right	Luz Matrícula Numberplate- lamp	Anti- Niebla Fog- lamp	Marcha Atrás Reversing lamp	Descripción Referencia O.E. Specification - O.E.-No.	Conector - Accesorios Connector - Spare Parts
A24-8000-007	1	■		■ lateral/ lateral	■		Con bombillas 12V incluidas Bulbs 12V fitted	
A24-8200-007	1		■	■ lateral/ lateral			Con bombillas 12V incluidas Bulbs 12V fitted	
A24-8210-007			■			■	Con bombillas 12V incluidas Bulbs 12V fitted	
A18-8480-007	1	■	■				Tulipa, incluye indicador de dirección Lens	
A13-0546-004	1	■	■				Kit conector Repairkit	

Piloto trasero

Rear Combination Lamp

Tipo: MULTIPOINT II



Función: Luz Posición, Freno, Intermitente, Antiniebla, Marcha Atrás, Triángulo Reflectante

Function: Dir.Indicator-, Stop-, Rear-, Fog-, Reverse-, Numberplate Lamp, Triangle Reflex Reflector

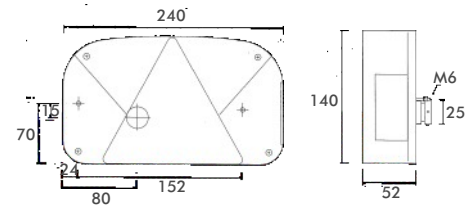

Referencia: Reference-No.	Ud. QTY	Izg. left	Dch. right	Luz Matrícula Numberplate- lamp	Anti- Niebla Fog- lamp	Marcha Atrás Reversing lamp	Descripción Referencia O.E. Specification - O.E.-No.	Conector - Accesorios Connector - Spare Parts
A24-7000-007	1	■		■ lateral/ lateral	■		Con bombillas 12V incluidas Bulbs 12V fitted	
A24-7200-007	1		■	■ lateral/ lateral			Con bombillas 12V incluidas Bulbs 12V fitted	
A24-7210-007	1		■	■ lateral/ lateral		■	Con bombillas 12V incluidas Bulbs 12V fitted	
A24-7000-207	1	■		■ abajo/ lateral	■		Con bombillas 12V incluidas Bulbs 12V fitted	
A24-7200-207	1		■	■ abajo/ lateral			Con bombillas 12V incluidas Bulbs 12V fitted	
A24-7200-307	1		■	■ abajo/ lateral		■	Con bombillas 12V incluidas Bulbs 12V fitted	
A18-8470-007	1	■	■				Tulipa Lens	
A13-0546-004	1	■	■				Kit Conector Repairkit	

Piloto trasero

Rear Combination Lamp





Tipo: MULTIPOINT I

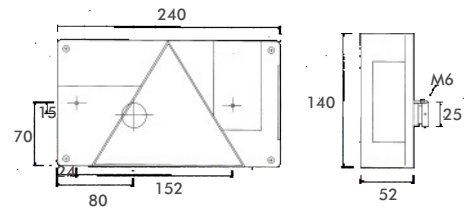

Función: Luz Posición, Freno, Intermitente, Antiniebla,
 Marcha Atrás, Luz Matricula, Triángulo Reflectante

Function: Dir.Indicator-, Stop-, Rear-, Fog-, Reverse-,
 Numberplate Lamp, Triangle Reflex Reflector



Referencia: Reference-No.	Ud. QTY	Izq. left	Dch. right	Luz Matrícula Numberplate- lamp	Anti- Niebla Fog- lamp	Marcha Atrás Reversing lamp	Descripción Referencia O.E. Specification - O.E.-No.	Conector - Accesorios Connector - Spare Parts
A24-5000-007	1	■		■ lateral/ lateral	■		Con Bombillas 12V incluidas Bulbs 12V fitted	
A24-5200-007	1		■	■ lateral/ lateral			Con Bombillas 12V incluidas Bulbs 12V fitted	
A24-5210-007	1		■	■ lateral/ lateral		■	Con Bombillas 12V incluidas Bulbs 12V fitted	
A18-8450-007	1	■			■		Tulipa Lens	
A18-8452-007	1		■				Tulipa Lens	
A18-8452-107	1		■			■	Tulipa Lens	
A13-0546-004	1	■	■				Kit conector Repairkit	

Piloto trasero

Rear Combination Lamp

Tipo: 5-Funciones

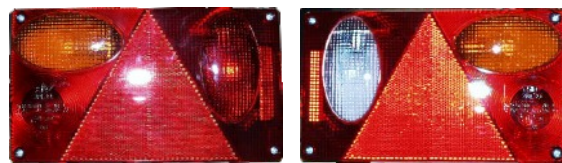

Función: Luz Posición, Freno, Intermitente, Antiniebla, Marcha Atrás, Triángulo Reflectante

Function: Dir.Indicator-, Stop-, Rear-, Fog-, Reverse-, Numberplate Lamp, Triangle Reflex Reflector

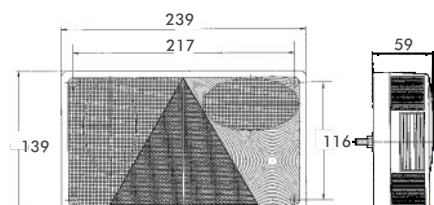

Referencia: Reference-No.	Ud. QTY	Izg. left	Dch. right	Luz Matrícula Numberplate- lamp	Anti- Niebla Fog- lamp	Marcha Atrás Reversing lamp	Descripción Referencia O.E. Specification - O.E.-No.	Conector - Accesorios Connector - Spare Parts
P40.233.011	1	■		■ lateral/ lateral	■			
P40.233.012	1		■	■ lateral/ lateral				
P40.233.013	1		■	■ lateral/ lateral		■		
P40.233.311	1	■		■ lateral/ lateral	■		Con bombillas 12V incluidas Bulbs 12V fitted	
P40.233.312	1		■	■ lateral/ lateral			Con bombillas 12V incluidas Bulbs 12V fitted	
P40.233.313	1		■	■ lateral/ lateral		■	Con bombillas 12V incluidas Bulbs 12V fitted	
P40.233.111	1	■			■		Tulipa Lens	
P40.233.112	1		■				Tulipa Lens	
P40.233.113	1		■			■	Tulipa Lens	
A13-0546-004	1	■	■				Kit conector Repairkit	

Piloto trasero

Rear Combination Lamp

Tipo: EARPOINT

Función: Luz Posición, Freno, Intermitente, Antiniebla, Marcha Atrás, Triángulo Reflectante

Function: Dir.Indicator-, Stop-, Rear-, Fog-, Reverse Lamp, Triangle Reflex Reflector

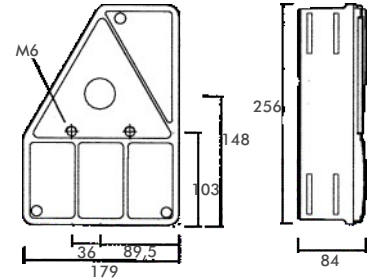

Referencia: Reference-No.	Ud. QTY	Izq. left	Dch. right	Luz Matrícula Numberplate- lamp	Anti- Niebla Fog- lamp	Marcha Atrás Reversing lamp	Descripción Referencia O.E. Specification - O.E.-No.	Conector - Accesorios Connector - Spare Parts
A24-4001-007	1	■			■		con Bombillas 12V incluidas Bulbs 12V fitted	
A24-4201-007	1		■				con Bombillas 12V incluidas Bulbs 12V fitted	
A24-4205-007	1		■			■	con Bombillas 12V incluidas Bulbs 12V fitted	
A18-8440-007	1	■			■		Tulipa Lens	
A18-8442-007	1		■				Tulipa Lens	
A18-8442-107	1		■			■	Tulipa Lens	
A13-0546-004	1	■	■				Kit Conector Repairkit	
A14-4952-014	1	■	■				Kit Instalación Installation Kit	

Piloto trasero

Rear Combination Lamp

Tipo: EARPOINT

Función: Luz Posición, Freno, Intermitente, Antiniebla,
 Marcha Atrás, Luz Matrícula, Cuerno balizamiento
 Lateral, Triángulo Reflectante

Function: Dir.Indicator-, Stop-, Rear-, Fog-, Reverse-, End Outline
 Marker Lamp, Triangle Reflex Reflector

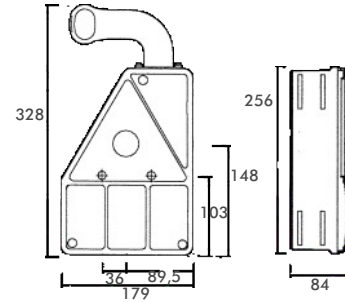

Referencia: Reference-No.	Ud. QTY	Izq. left	Dch. right	Luz Matrícula Numberplate- lamp	Anti- Niebla Fog- lamp	Marcha Atrás Reversing lamp	Descripción Referencia O.E. Specification - O.E.-No.	Conector - Accesorios Connector - Spare Parts
A24-4051-007	1	■			■		Con bombillas 12V incluidas Bulbs 12V fitted	
A24-4251-007	1		■				Con bombillas 12V incluidas Bulbs 12V fitted	
A24-4255-007	1		■			■	Con bombillas 12V incluidas Bulbs 12V fitted	
A18-8440-007	1	■			■		Tulipa Lens	
A18-8442-007	1		■				Tulipa Lens	
A18-8442-107	1		■			■	Tulipa Lens	
A31-3802-077	1	■						
A31-3803-077	1		■					
50 047 000	1	■	■				Kit conector Repairkit	
A14-4952-014	1	■	■				Kit instalación Installation Kit	

Piloto trasero

Rear Combination Lamp

Tipo: EARPOINT III

Función: Luz Posición, Freno, Intermitente, Antiniebla,
Marcha Atrás, Luz Matrícula, Triángulo Reflectante

Function: Dir.Indicator-, Stop-, Rear-, Fog-, Reverse Lamp,
Triangle Reflex Reflector

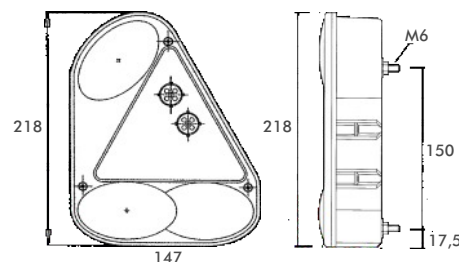

Referencia: Reference-No.	Ud. QTY	Izq. left	Dch. right	Luz Matrícula Numberplate- lamp	Anti- Niebla Fog- lamp	Marcha Atrás Reversing lamp	Descripción Referencia O.E. Specification - O.E.-No.	Conector - Accesorios Connector - Spare Parts
A24-4700-007	1	■			■		Con bombillas 12V incluidas Bulbs 12V fitted	
A24-4800-007	1		■				Con bombillas 12V incluidas Bulbs 12V fitted	
A24-4810-007	1		■			■	Con bombillas 12V incluidas Bulbs 12V fitted	
A18-8447-007	1	■			■		Tulipa Lens	
A18-8448-007	1		■				Tulipa Lens	
A18-8448-107	1		■			■	Tulipa Lens	
A13-0546-004	1	■	■				Kit conector Repairkit	
A15-5303-007	1	■	■				Kit instalación Installation Kit	

Kits de Luces

Lighting Kits



Vista lateral
side view



Vista Trasera
Back view

Referencia: Reference-No.	Ud. QTY	Descripción Specification	
P40.305.600	1	<ul style="list-style-type: none"> - Kit de Luces Magnético - 2 x Pilotos traseros Posición-Freno-Intermitente 12V - 7,5m de cable con conector macho 7p. incluido - 2,5m de cable entre pilotos 	<ul style="list-style-type: none"> - Magnetic Lighting Kit - 2 x Dir.Indicator-,Stop-, Rearlamps 12V - 7,5m Cable incl. Plug 7-poles - 2,5m Cable between the lights
P40.305.700	1	<ul style="list-style-type: none"> - Kit de Luces Magnético - 2 x Pilotos traseros Posición-Freno-Intermitente 12V - 10m de cable con conector macho 7p. incluido - 2,5m de cable entre pilotos 	<ul style="list-style-type: none"> - Magnetic Lighting Kit - 2 x Dir.Indicator-,Stop-, Rearlamps 12V - 10m Cable incl. Plug 7-poles - 2,5m Cable between the lights



Referencia: Reference-No.	Ud. QTY	Descripción Specification	
P40.305.200	1	<ul style="list-style-type: none"> - Kit de instalación - Kit de luces ajustable a partir de 1.60m. - 2 x Pilotos traseros Posición-Freno-Intermitente 12V - 7,5m de cable con conector macho 7p. incluido - 2 x Triángulo reflectante + portamatrícula 	<ul style="list-style-type: none"> - 2 x Dir.Indicator-,Stop-,Rearlamps 12V - Lighting Kit adjustable up to 1,60m - 10m Cable incl. Plug 7-poles - 2 x Triangle-Reflex Reflec. + Registration Plate - Fixing Kit

Parachoques Traseros

Rear Bumpers



Parachoques LED PRO-SPOT
LED Rear Bumper PRO-SPOT



Referencia: Reference-No.	Ud. QTY	Parachoques de Aluminio Rear bumper Aluminium	
P97.019.000	1	Parachoques de Aluminio 2400mm Descripción y Componentes: - 2 x Pilotos 3 funciones LED PRO-SPOT - 2 X Antiniebla - Marcha Atrás LED PRO-SPOT FR - 2 x Luz Matrícula LED - 2 x Cuerno gálibo Superpoint III LED - 2 x Triángulos reflectantes PRO-REFLEX - 1 x Caja conexiones SCAN BOX - Completamente cableado y listo para instalación - 1 x Conector 8 polos para SCAN BOX - Color blanco Kit conector macho 15p. para conexión con parachoques.	Rear Bumper Aluminium 2400mm Specification: - 2 x LED 3 Function lamp PRO-SPOT - 2 x LED Fog - Reversing lamp PRO-SPOT FR - 2 x LED End outline marker lamp Superpoint III - 2 x LED Registration plate lamp - 2 x Triangle Reflex Reflector PRO-REFLEX - 1 x Junction Box SCAN-BOX - complete cabled, ready for instalation - 8 Poles connection to SCAN-BOX - colour white
EX-47284-M55	1	Paracheque de Aluminio NACIONAL 2400mm, M55 REV.3, Anodizado, Sin pilotos	
EX-47284-M56	1	Paracheque de Aluminio INTERNACIONAL 2400mm, M56 REV.3, Anodizado, Sin pilotos	
EX-4163-07	1	Paracheque de Aluminio 2400mm, Color gris Sin pilotos Rear Bumper Aluminium 2400mm, grey colour without rear lamps	
A15-5272-007	1	Tapa protectora izquierda Paracheque EX47284-M55 & EX47284-M56	
A15-5272-017	1	Tapa protectora derecha Paracheque EX47284-M55 & EX47284-M56	
A15-5394-014	1	Kit tapas para el Paracheque de Aluminio EX4163-07 Cover kit for the Rear Bumper	

Antiniebla LED/ Marcha Atrás LED	LED Fog Lamps/LED Reversing Lamps	2.0	- 2.7
Antiniebla/Marcha Atrás Intermitente LED	Fog Lamps/Reversing Lamps	2.8	
3° Luz de Freno LED	LED Direction Indicator Lamps	2.9	- 2.13.2
	LED 3rd Stop Lamps	2.14	- 2.14.1



*straßentaug***LICHT**

NEW

ASPÖCK
IBERICA

PROPLAST

FAHRZEUGBELEUCHTUNG

www.aspock.com

Catálogo 2022/2023

Pilotos Antiniebla y Marcha Atrás LED

LED Fog - / Reversing Lamp

Tipo: PRO-TWIN-CAN

Función: Antiniebla LED - Marcha Atrás LED

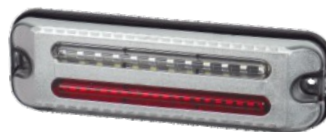

Function: LED Fog Lamp - LED Reversing Lamp

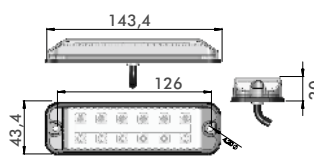

Superficie /Pendant

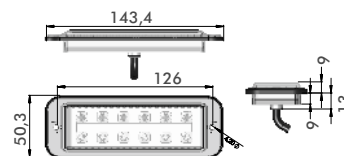

Empotrable /Recessed

Referencia: Reference-No.	Ud. QTY	Izq. left	Dch. right	Luz Matrícula Numberplate- lamp	Descripción - Referencia O.E. Specification - O.E.-No.	Conector - Accesorios - Recambios Connector - Accessories - Spare Parts
P40.073.002 Superficie Pendant	1	■	■		<p>Diseño exclusivo y compacto carcasa metalizada Tulipa: PMMA Conexión: 0,5m puntas abiertas Voltaje: 12/24 Volt Protección: IP6K9K Montaje: horizontal / vertical Homolog.: ECE ADR EMV</p> <p>Antiniebla: 12V-1,0W / 24V-2,0W M. Atrás: 12V-1,0W / 24V-2,0W</p> <p>Unique compact design metalized cover</p>	
P40.073.702 Empotrable Recessed	1	■	■		<p>Lens: PMMA Cable: 0,5m open end Voltage: 12/24 Volt Protection: IP6K9K Fixation: horizontal / vertical Homologation: ECE approved ADR approved EMC approved</p> <p>Fog: 12V-1,0W / 24V-2,0W Reverse : 12V-0,3W / 24V-0,6W</p>	

NEW

Pilotos Antiniebla y Marcha Atrás LED

LED Fog - / Reversing Lamp

Tipo: PRO-LOOP

Función: Antiniebla LED - Marcha Atrás LED

Function: LED Fog Lamp - LED Reversing Lamp

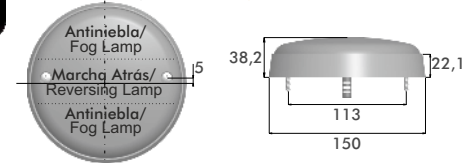





Referencia: Reference-No.	Ud. QTY	Izq. left	Dch. right	Luz Matrícula Numberplate- lamp	Descripción - Referencia O.E. Specification - O.E.-No.	Conector - Accesorios - Recambios Connector - Accessories - Spare Parts
P40.149.292 Anillo exterior Cromado body ring chrome	1	■	■		Incremento de protección gracias a su bajo perfil Diseño Moderno Doble Antiniebla Carcasa: ABS Tulipa: PMMA Anillo: ABS Conexión: 0,5m puntas abiertas Voltaje: 12/24 Volt Protección: IP6K9K Homolog.: ECE ADR EMV Antiniebla: 12V-1,9W / 24V-1,9W M. Atrás: 12V-0,5W / 24V-0,5W	
P40.149.242 Anillo exterior Negro body ring glossy black	1	■	■		Increased protection thanks to low profile Modern design Double Fog light Single Reverse light Housing: ABS Lens: PMMA Body ring: ABS Cable: 0,5m open end Voltage: 12/24 Volt Protection: IP6K9K Homologation: ECE approved ADR approved EMC approved Fog: 12V-0,5W / 24V-0,5W Reverse: 12V-2,1W / 24V-2,1W	
P40.149.252 Anillo exterior Blanco body ring glossy white	1	■	■			

Pilotos Antiniebla y Marcha Atrás LED

LED Fog -/ Reversing Lamp

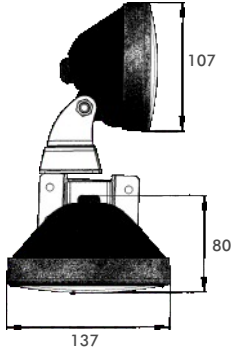
Tipo: PRO-FOG, PRO-REAR, PRO-REVERSE

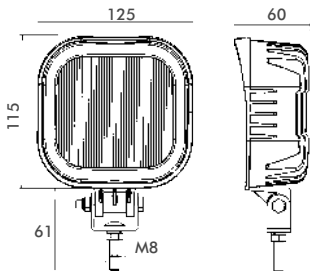

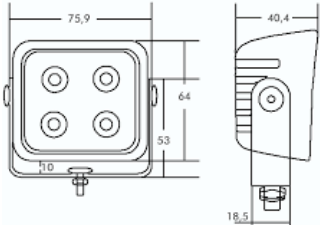
Referencia: Reference-No.	Ud. QTY	Descripción Description	Piloto LED LED Lamps	Tecnología LED LED Technology
P40.460.802	1	<p>Antiniebla LED PRO-FOG, acorde con ECE 38, alta intensidad de luz debido a la brillante tecnología de diseño libre, 6 LED alta potencia, tulipa irrompible PC, Cable 1,75m ADR, 12V-6,2W,24V-7,7W</p> <p>LED FOG Lamp PRO-FOG accord. to ECE R38, high intensity light due to brilliant free-form technology, 6 high power LEDs, Lens made of unbreakable PC, cable 1,75m, ADR-appr., 12V-6,2W, 24V-7,7W</p>		
P40.460.903	1	<p>Marcha Atrás LED PRO-REAR, acorde con ECE R23, alta intensidad de luz debido a la brillante tecnología de diseño libre, 6 LED alta potencia, tulipa irrompible PC, Cable 1,75m ADR,12V-6,2W,24V-7,7W</p> <p>LED Reversing Lamp PRO-REAR accord. to ECE R23, high intensity light due to brilliant free-form technology, 6 high power LEDs, Lens made of unbreakable PC, cable 1,75m, ADR-appr., 12V-6,2W, 24V-7,7W</p>		
P40.466.003	1	<p>Marcha Atrás LED PRO-REVERSE, acorde con ECE R23, tulipa transparente e irrompible PC, Leds alta potencia, pequeño diseño compacto y solido, Cable 0.50m ADR, 12V/24V</p> <p>LED Reversing Lamp PRO-REVERSE, according to ECE R23, clear lens made of unbreakable PC, small, solid housing, cable 0,5m, ADR-appr., 12V/24V</p>		
P40.424.003	1	<p>Faro de trabajo y Luz de marcha atrás LED PRO-FIELD, iluminación homogénea, perfil extremadamente compacto, carcasa de aluminio, tulipa policarbonado, ECE R23, 4 LEDs cable 0,5m, ADR,9V/32V /12W Potencia de luz: 800Lumen</p> <p>LED Reversing Lamp PRO-REVERSE, according to ECE R23, clear lens made of unbreakable PC, small, solid housing, cable 0,5m, ADR-appr., 12V/24V</p>		

Pilotos Antiniebla y Marcha Atrás LED

LED Fog -/ Reversing Lamp

Tipo: PRO-SPOT ECO FR & PRO-SPOT FR









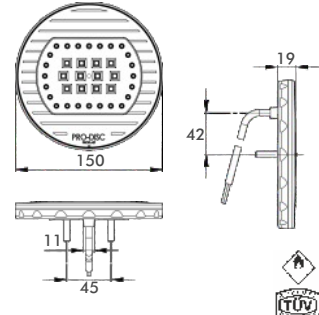

Referencia Reference-No.	Ud. QTY	Descripción Description	Piloto LED LED Lamp	Tecnología LED LED Technology
P40.025.502	1	<p>Piloto LED-PRO-SPOT ECO FR, Antiniebla / Marcha Atrás, ADR & ECE R10, 12/24V, Cable 0,5m</p> <p>LED-Fog-/Reversing Lamp PRO-SPOT ECO FR, 12/24V, cable 0,5m</p>		
P40.025.522	1	<p>PRO-SPOT ECO FR, con cable 0,5m + conector 7p.</p> <p>PRO-SPOT ECO FR, cable 0,5m + 7-pol. AMP con.</p>		
P40.025.002	1	<p>Piloto LED PRO-SPOT FR, Antiniebla / Marcha Atrás, Racor PG Posterior 10-30V</p> <p>LED Fog-/Reversing Lamp PRO-SPOT FR, 10-30V, with PG-screw</p>		
P40.025.462	1	<p>Piloto LED PRO-SPOT FR, Antiniebla / Marcha Atrás con cable 2m, 10-30V,</p> <p>LED Fog-/Reversing Lamp PRO-SPOT FR, 10-30V, incl. 2m cable</p>		
P40.019.102	1	<p>Kit montaje Cromado para piloto LED PRO-SPOT FR Antiniebla / Marcha Atrás</p> <p>Built-In Kit chrome for LED fog-/reversing lamp PRO-SPOT FR</p>		
P20.105.004	1	<p>Triángulo Reflectante PRO-REFLEX Diámetro 145mm</p> <p>Triangle Reflex Reflector PRO-REFLEX</p>	<p>P40.019.102</p>	<p>P20.105.004</p>

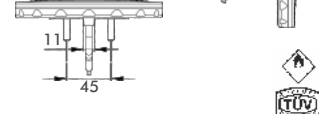
Pilotos Antiniebla y Marcha Atrás LED

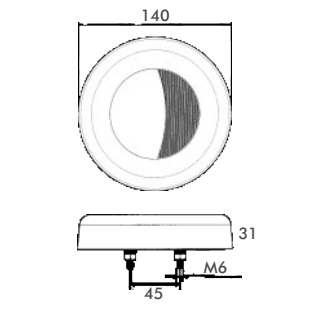
LED Fog -/ Reversing Lamp

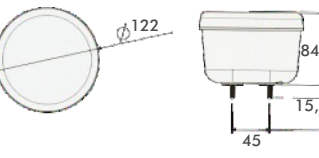

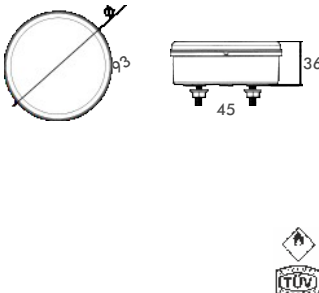

Referencia Reference-No.	Ud. QTY	Descripción Description	Piloto LED LED Lamp	Tecnología LED LED Technology
P40.053.002	1	Piloto LED PRO-DISC FR , Antiniebla y Marcha Atrás ADR & ECE R10, 12/24V, Cable 1,8m LED-Fog-/Reversing Lamp PRO-DISC FR , 12/24V, cable 1,8m		
P40.053.202	1	PRO-DISC FR , Cable 0,3m + conector 7p. PRO-DISC FR , cable 0,3m + 7-pol. AMP connector		
P40.051.002	1	Piloto LED PRO-RING FR , Antiniebla y Marcha Atrás, Luz de Posición Guía de LED en el anillo exterior. 12/24V, Cable 0,5m LED-Fog-/Reversing Lamp incl. LED Tail lamp in the outer ring, PRO-RING FR , 12/24V, cable 0,5m		
P40.278.002	1	Piloto LED PRO-WAY FR , Antiniebla y Marcha Atrás 12/24V, Cable 0,3m LED-Fog-/Reversing Lamp PRO-WAY FR , 12/24V, cable 0,3m		
P40.283.002	1	Piloto LED PRO-TOP FR , Antiniebla y Marcha Atrás, 12/24V, ADR, Cable 0,5m LED-Fog-/Reversing Lamp PRO-TOP FR , 12/24V, ADR approved, cable 0,5m		

Pilotos Antiniebla y Marcha Atrás LED

LED Fog -/ Reversing Lamp

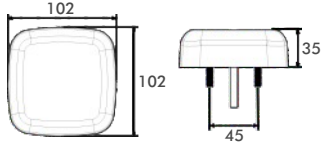
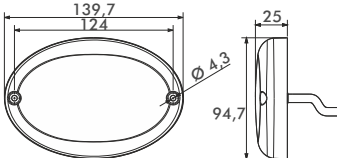









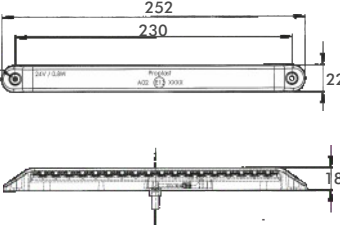

Referencia Reference-No.	Ud. QTY	Descripción Description	Piloto LED LED Lamp	Tecnología LED LED Technology
P40.288.002	1	<p>Piloto LED PRO-ROAD FR, Antiniebla y Marcha Atrás, 12/24V, IP6K9K, Cable 0,5m</p> <p>LED-Fog-/Reversing Lamp PRO-ROAD FR, 12/24V, IP6K9K geprüft, cable 0,5m</p>		
P40.057.002	1	<p>Piloto LED PRO-SQUARE, Antiniebla y Marcha Atrás 12/24V, IP6K9K, Cable 0,5m</p> <p>LED-Fog-/Reversing Lamp PRO-SQUARE, 12/24V, IP6K9K approved, cable 0,5m</p>		
P40.057.502	1	<p>PRO-SQUARE FR, con Luz de Matrícula lateral</p> <p>PRO-SQUARE FR, dito., with lat. Numberplate Lamp</p>		
P40.057.602	1	<p>PRO-SQUARE FR, con Luz de Matrícula abajo</p> <p>PRO-SQUARE FR, dito., with Numberplate Lamp below</p>		
P40.058.002	1	<p>Piloto LED PRO-OVAL, Antiniebla y Marcha Atrás 12/24V, IP6K9K, Cable 0,5m</p> <p>LED-Fog-/Reversing Lamp PRO-OVAL, 12/24V, IP6K9K approved, cable 0,5m</p>		
P40.052.022 24V	1	<p>Piloto LED PRO-STRIPE ECE II, Antiniebla y Marcha Atrás, homologado para fijación horizontal o vertical, IP6K9K, Cable 0,5m</p>		
P40.052.222 12V	1	<p>LED Fog-/Reversing Lamp PRO-STRIPE ECE II, approved for horizontal and vertical fixation, IP6K9K approved, cable 0,5m</p>		

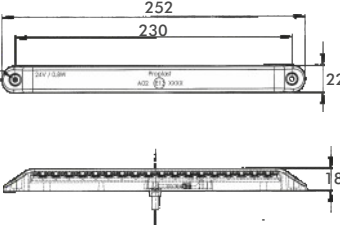
Pilotos Antiniebla y Marcha Atrás LED

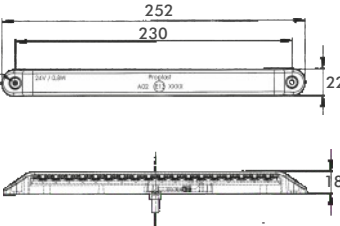
LED Fog -/ Reversing Lamp

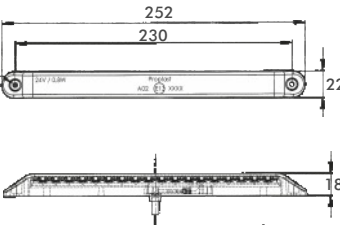
Tipo: PRO-CAN XL

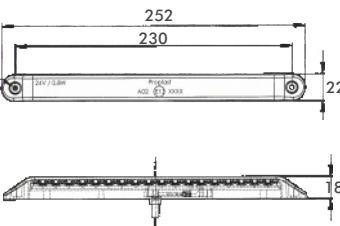

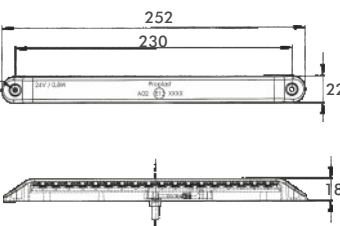
Referencia Reference-No.	Ud. QTY	Descripción Description	Piloto LED LED Lamp	Tecnología LED LED Technology
P40.026.022 24V	2	Piloto LED PRO-CAN XL rojo, Antiniebla, Cable 0,5m, a prueba de agua, versión homologada para fijación horizontal o vertical, 24V/3W LED Fog Lamp PRO-CAN XL , red, cable 0,5m, potted version, for horizontal or vertical fixation, 24V/3W	 18 LEDs	
P40.026.222 12V	2	Piloto LED PRO-CAN XL rojo, Antiniebla, Cable 0,5m, a prueba de agua, versión homologada para fijación horizontal o vertical, 12V/3W LED Fog Lamp PRO-CAN XL red, cable 0,5m, potted version, for horizontal or vertical fixation, 12V/3W	 18 LEDs	
P40.026.422 24V	2	Piloto LED PRO-CAN XL rojo, Antiniebla, Cable 0,5m, a prueba de agua, versión homologada para fijación horizontal o vertical tulipa transparente, 24V/3W LED Fog Lamp PRO-CAN XL red, clear lens, cable 0,5m, potted version, for horizontal or vertical fixation, 24V/3W	 18 LEDs	
P40.026.322 12V	2	Piloto LED PRO-CAN XL rojo, Antiniebla, Cable 0,5m, a prueba de agua, versión homologada para fijación horizontal o vertical tulipa transparente, 12V/3W LED Fog Lamp PRO-CAN XL red, clear lens, cable 0,5m, potted version, for horizontal or vertical fixation, 12V/3W	 18 LEDs	
P40.026.503 24V	2	Piloto LED PRO-CAN XL blanco, Marcha Atrás, Cable 0,5m, a prueba de agua, versión homologada para fijación horizontal o vertical, 24V 3W LED Reversing Lamp PRO-CAN XL white, incl.cable 0,5m, potted version, for horizontal or vertical fixation, 24V/3W	 18 LEDs	
P40.026.523 12V	2	Piloto LED PRO-CAN XL blanco, Marcha Atrás, Cable 0,5m, a prueba de agua, versión homologada para fijación horizontal o vertical, 12V/3W LED Reversing Lamp PRO-CAN XL white, incl.cable 0,5m, potted version, for horizontal or vertical fixation, 12V/3W	 18 LEDs	

Pilotos Antiniebla y Marcha Atrás LED

LED Fog -/ Reversing Lamp

Tipo: PRO-MINI-RING



Referencia Reference-No.	Ud. QTY	Descripción Description	Piloto LED LED Lamp	Tecnología LED LED Technology
P40.054.022	1	Piloto LED PRO-MINI-RING , Antiniebla, versión superficie, Cable 0,5m, 12/24V, ADR. LED Fog Lamp PRO-MINI-RING , pendant version, cable 0,5m, 12/24V, ADR appr.		
P40.054.003	1	Piloto LED PRO-MINI-RING , Marcha Atrás, versión superficie, Cable 0,5m, 12/24V, ADR. LED Reversing Lamp PRO-MINI-RING , pendant version, cable 0,5m, 12/24V, ADR appr.		
P40.054.522	1	Piloto LED PRO-MINI-RING , Antiniebla, versión empotrable, Anillo acero inoxidable, Cable 0,5m, 12/24V, ADR. LED Fog Lamp PRO-MINI-RING , recessed version, stainless steel ring, cable 0,5m, 12/24V, ADR appr.		
P40.054.503	1	Piloto LED PRO-MINI-RING , Marcha Atrás, versión empotrable, Anillo acero inoxidable, Cable 0,5m, 12/24V, ADR. LED Reversing Lamp PRO-MINI-RING , recessed version, stainless steel ring, cable 0,5m, 12/24V, ADR appr.		
A27-8400-707	1	Piloto LED ASPÖCK, Antiniebla, racor PG 11 12/24V, IP54, ADR LED Fog Lamp, racor PG 11, IP 54 12/24V, ADR appr.		
A28-8400-707	1	Piloto LED ASPÖCK, Marcha Atrás, racor PG 11 12/24V, IP54, ADR LED Reversing Lamp racor PG 11, IP 54 12/24V, ADR appr.		

Pilotos Antiniebla y Marcha Atrás LED





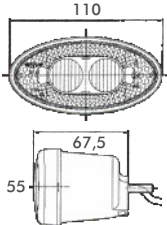



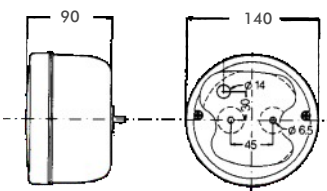

LED Fog -/ Reversing Lamp

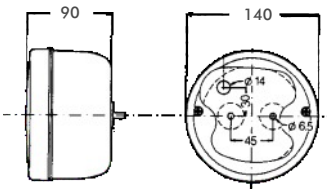

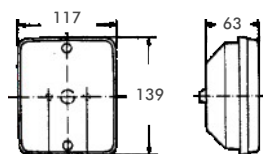
Referencia Reference-No.	Ud. QTY	Descripción Description	Piloto LED LED Lamp	Tecnología LED LED Technology
P40.149.202	1	Piloto LED Antiniebla y Marcha Atrás, Cable 0,5m, IP6K9K, 12/24V LED-Fog-/Reversing Lamp cable 0,5m, IP6K9K geprüft, 12/24V		
P40.149.402	1	Piloto LED Antiniebla 24V LED Fog Lamp 124V		
P40.149.403	1	Piloto LED Marcha Atrás 24V LED Reversing Lamp 24V		
P40.031.002	1	Piloto LED Antiniebla tulipa transparente, óptica FF, con espejo brillante Cable 0,5m, 12/24V LED Fog Lamp, clear glas ff-optic with brilliant mirror, cable 0,5m, 12/24V		
P40.031.003	1	Piloto LED Marcha Atrás tulipa transparente, óptica FF- con espejo brillante, Cable 0,5m, 12/24V LED Reversing Lamp, clear glas ff-optic with brilliant mirror, cable 0,5m, 12/24V		
P40.294.003	1	Piloto LED PRO-ROAD LG R, Marcha Atrás, Luz de posición con Guía de LED, 12/24V, IP69K, Cable 0,5m LED-Reversing Lamp incl. LED Tail lamp in light guide technology PRO-ROAD LG R, 12/24V, IP69K approved, cable 0,5m		

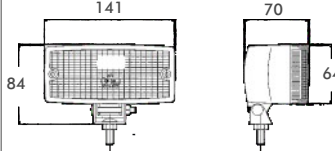
Pilotos Antiniebla y Marcha Atrás

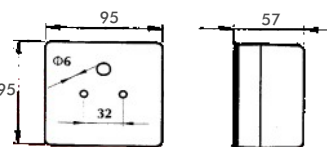
Fog -/ Reversing Lamp

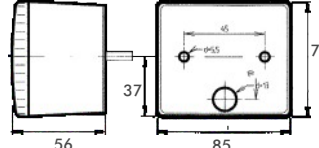
Referencia Reference-No.	Ud. QTY	Descripción Description	Antiniebla/M. Atrás Fog/Reversing Lamp	BA 15s / P21W
P40.149.002	1	Piloto Antiniebla Fog Lamp		
P40.149.003	1	Piloto Marcha Atrás Reversing Lamp		
A27-6600-017	1	Piloto Antiniebla Fog Lamp		
A27-6610-027	1	Piloto Antiniebla Reversing Lamp		
P40.130.002	1	Piloto Antiniebla Fog Lamp		
P40.130.003	1	Piloto Marcha Atrás Reversing Lamp		
P40.132.002	1	Piloto Antiniebla Fog Lamp		
P40.132.003	1	Piloto Marcha Atrás Reversing Lamp		
P40.162.002	1	Piloto Antiniebla Fog Lamp		
P40.162.003	1	Piloto Marcha Atrás Reversing Lamp		
P40.183.002	1	Piloto Antiniebla Fog Lamp		

Intermitente Frontal y Luz de Posición LED

Front LED Direction Indicator-/Position Lamp

Tipo: PRO-TWIN-CAN

Función: Intermitente Frontal LED Categoría 1a - Posición LED

Intermitente unidad de control acorde ISO 13207-1

Function: LED Dir. Indicator Lamp Category 1a - LED Position Lamp

Flasher control unit according to ISO 13207-1

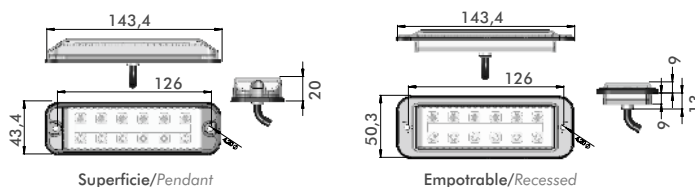









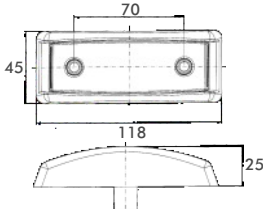

Referencia: Reference-No.	Ud. QTY	Izq. left	Dch. right	Luz Matrícula Numberplate- lamp	Descripción - Referencia O.E. Specification - O.E.-No.	Conector - Accesorios - Recambios Connector - Accessories - Spare Parts
P40.073.911 Superficie Pendant 	1	■	■		Intermitente con Unidad de control acorde ISO 13207-1 Diseño compacto y exclusivo carcasa metalizada Tulipa: PMMA Conexión: 0,5m puntas abiertas Voltaje: 12/24 Volt Protección: IP6K9K Montaje: horizontal / vertical Homolog.: ECE ADR EMV Intermitente: 12V-3,0W / 24V-6,0W Posición: 12V-0,6W / 24V-1,2W	
P40.073.811 Empotrable Recessed 	1	■	■		Flasher control unit according to ISO 13207-1 unique compact design metalized cover Lens: PMMA Cable: 0,5m open end Voltage: 12/24 Volt Protection: IP6K9K Fixation: horizontal / vertical Homologation: ECE approved ADR approved EMC approved Dir. Indicator: 12V-3,0W / 24V-6,0W Position: 12V-0,6W / 24V-1,2W	
P40.078.001 Superficie Pendant 	1	■	■		Intermit. lateral LED PRO-WING II Categoría 5 & 6 Controlador Intermitente (LCG) Carcasa: Aluminio Tulipa: Policarbonato Conexión: 0,5m puntas abiertas Voltaje: 24 Volt Protección: IP67 Homolog.: ECE EMV Consumo: 24V-5,0W Lateral LED Dir. Indicator Lamp according to category 5 & 6 integr. flasher control unit (LCG) Housing: Aluminium Lens: Polycarbonate Cable: 0,5m open end Voltage: 24 Volt Protection: IP67 Homologation: ECE approved EMC approved Consumption: 24V-5,0W	

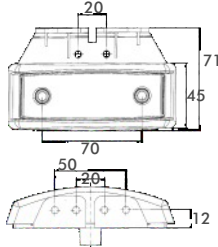
Piloto Intermitente LED

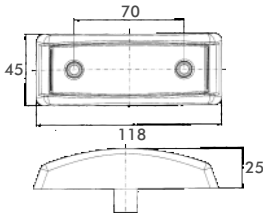
LED Direction Indicator Lamp

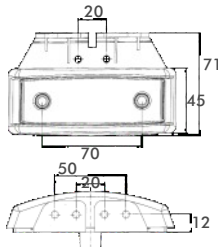
Tipo: PRO-MULTI-SML



Referencia Reference-No.	Ud. QTY	Descripción Description	Piloto Intermitente LED LED Sidemarker / Dir. Indicator Lamps	Tecnología LED LED Technology
P40.049.801	2	<p>Piloto PRO-MULTI-SML, combina función de Intermitencia Cat. 5 y posición lateral, Cable 0,5m, 10-32V/1,6W, IP6K9K, ADR.</p> <p>LED Sidemarker Lamp incl. lateral LED Direction Indicator Lamp cat. 5, PRO-MULTI-SML, cable 0,5m, 10-32V/1,6W, IP6K9K, ADR approved</p>	 <p>Categoría 5 lateral + LED SML</p>	
P40.049.821	2	<p>Piloto PRO-MULTI-SML, combina función de Intermitencia Cat. 5 y posición lateral, soporte 90° Cable 0,5m, 10-32V/1,6W, IP6K9K, ADR.</p> <p>LED Sidemarker Lamp incl. lateral LED Direction Indicator Lamp cat. 5, PRO-MULTI-SML, cable 0,5m, bracket 90°, 10-32V/1,6W, IP6K9K, ADR approved</p>	 <p>Categoría 5 lateral+ LED SML</p>	
P40.049.501	2	<p>Piloto PRO-MULTI-SML, combina función de Intermitencia Cat. 5 y posición lateral, Conector AMP SUPER SEAL 3p., 10-32V/1,6W, IP6K9K, ADR.</p> <p>LED Sidemarker Lamp incl. lateral LED Direction Indicator Lamp cat. 5, PRO-MULTI-SML, AMP SS con. 3-poles, 10-32V/1,6W, IP6K9K, ADR approved</p>	 <p>Categoría 5 lateral + LED SML</p>	
P40.049.521	2	<p>Piloto PRO-MULTI-SML, combina función de Intermitencia Cat. 5 y posición lateral, soporte 90° Conector AMP SUPER SEAL 3p., 10-32V/1,6W, IP6K9K, ADR.</p> <p>LED Sidemarker Lamp incl. lateral LED Direction Indicator Lamp cat. 5 PRO-MULTI-SML, AMP SS conntor. 3-poles, bracket 90°, 10-32V/1,6W, IP6K9K, ADR approved</p>	 <p>Categoría 5 lateral + LED SML</p>	
P50.079.400	1	<p>Conector hembra AMP SUPER SEAL 3p.</p> <p>Connector 3-poles female, AMP SUPER SEAL</p>		
P50.141.012 12V	1	<p>Controlador LED PRO-CONTROL monitoriza la función Intermitencia</p>		+ info. página 9.0.0
P50.141.024 24V	1	<p>LED Control Gear PRO-CONTROL monitors the Direction Indicator function</p>		LED Control Gear see also catalogue page 9.0

Piloto Intermitente LED

LED Direction Indicator Lamp

Tipo: PRO-CAN XL



Referencia Reference-No.	Ud. QTY	Descripción Description	Piloto Intermitente LED LED Sidemarker / Dir. Indicator Lamps	Tecnología LED LED Technology
P40.026.011 24V	2	Intermitente LED PRO-CAN XL , Frontal, Cat. 1a, Cable 0,5m, a prueba de agua, versión homologada para fijación horizontal o vertical		
P40.026.211 12V	2	Front LED Dir. Indicator Lamp PRO-CAN XL , cat. 1a incl. cable 0,5m, potted version, for horizontal or vertical fixation	Categoría 1a 18 LEDs	
P40.026.031 24V	2	Intermitente LED PRO-CAN XL , Frontal, Cat. 1a, Cable 0,5m, Tulipa transparente a prueba de agua, versión homologada para fijación horizontal o vertical		
P40.026.231 12V	2	Front LED Dir. Indicator Lamp PRO-CAN XL , cat. 1a, clear lens, cable 0,5m, potted version, for horizontal or vertical fixation	Categoría 1a 18 LEDs	
P40.026.501 24V	2	Intermitente LED PRO-CAN XL , Trasero, Cat. 2a, Cable 0,5m, a prueba de agua, versión homologada para fijación horizontal o vertical		
P40.026.521 12V	2	Rear LED Dir. Indicator Lamp PRO-CAN XL , cat. 2a incl. cable 0,5m, potted version, for horizontal or vertical fixation	Categoría 2a 18 LEDs	
P40.026.601 24V	2	Intermitente LED PRO-CAN XL , Trasero, Cat. 2a, Cable 0,5m, Tulipa transparente a prueba de agua, versión homologada para fijación horizontal o vertical		
P40.026.621 12V	2	Rear LED Dir. Indicator Lamp PRO-CAN XL , cat. 2a, clear lens, cable 0,5m, potted version, for horizontal or vertical fixation	Categoría 2a 18 LEDs	
P40.026.701 24V	2	Intermitente LED PRO-CAN XL , Lateral, Cat. 5a, Cable 0,5m, a prueba de agua, versión homologada para fijación horizontal o vertical		
P40.026.721 12V	2	Lateral LED Dir. Indicator Lamp PRO-CAN XL , cat.5 incl. cable 0,5m, potted version, for horizontal or vertical fixation	Categoría 5 18 LEDs	
P40.026.801 24V	2	Intermitente LED PRO-CAN XL , Lateral, Cat. 5a, + Luz posición lateral, Cable 0,5m, a prueba de agua, versión homologada para fijación horizontal o vertical		
		LED SML + Lateral LED Dir. Indicator Lamp PRO-CAN XL , cat.5 incl. cable 0,5m, potted version, for horizontal or vertical fixation	Categoría 5 + LED SML 18 LEDs	

Piloto Intermitente LED

LED Direction Indicator Lamp

Tipo: PRO-CAN XL
Luz de Giro Secuencial











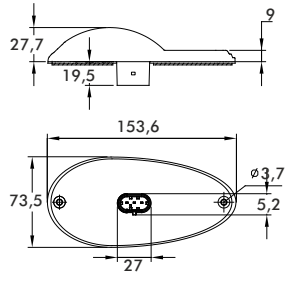

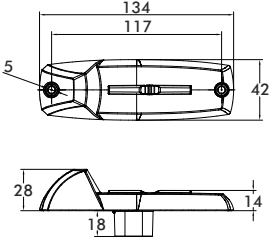
Referencia Reference-No.	Ud. QTY	Descripción Description	Piloto Intermitente LED LED Sidemarker / Dir. Indicator Lamps	Tecnología LED LED Technology
P40.026.061 24V	2	Intermitente LED PRO-CAN XL , con luz de giro secuencial, Frontal Cat. 1a, Cable 0,5m, a prueba de agua, versión homologada para fijación horizontal o vertical, ADR, IP67	 Categoría 1a 18 LEDs	
P40.026.261 12V	2	Front LED Dir. Indicator Lamp PRO-CAN XL , sequential turn signal, cat. 1a, cable 0,5m, potted version, for horizontal fixation, ADR-appr. IP67		
P40.026.071 24V	2	Intermitente LED PRO-CAN XL , con luz de giro secuencial, Tulipa transparente, Frontal Cat. 1a, Cable 0,5m, a prueba de agua, versión homologada para fijación horizontal o vertical, ADR, IP67	 Categoría 1a 18 LEDs	
P40.026.271 12V	2	Front LED Dir. Indicator Lamp PRO-CAN XL , sequential turn signal, cat. 1a, cable 0,5m, clear lens, potted version, for horizontal fixation, ADR-appr. IP67		
P40.026.041 24V	2	Intermitente LED PRO-CAN XL , con luz de giro secuencial, Trasero Cat. 2a, Cable 0,5m, a prueba de agua, versión homologada para fijación horizontal o vertical, ADR, IP67	 Categoría 2a 18 LEDs	
P40.026.241 12V	2	Rear LED Dir. Indicator Lamp PRO-CAN XL , sequential turn signal, cat. 2a, cable 0,5m, potted version, for horizontal fixation, ADR-appr. IP67		
P40.026.051 24V	2	Intermitente LED PRO-CAN XL , con luz de giro secuencial, Tulipa transparente, Trasero Cat. 2a, Cable 0,5m, a prueba de agua, versión homologada para fijación horizontal o vertical, ADR, IP67	 Categoría 2a 18 LEDs	
P40.026.251 12V	2	Rear LED Dir. Indicator Lamp PRO-CAN XL , sequential turn signal, cat. 2a, cable 0,5m, clear lens, potted version, for horizontal fixation, ADR-appr. IP67		
P50.141.012 12V	1	Controlador LED PRO-CONTROL monitoriza la función Intermitencia		+ info. página 9.0.0
P50.141.024 24V	1	LED Control Gear PRO-CONTROL monitors the Direction Indicator function		LED Control Gear see also catalogue page 9.0

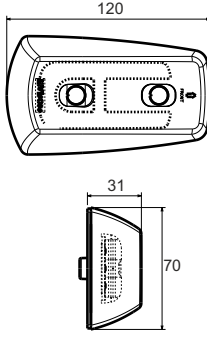
Piloto Intermitente LED

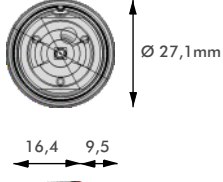
LED Direction Indicator Lamp

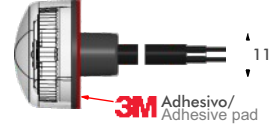

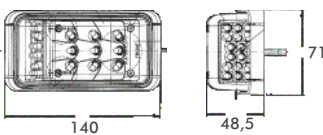

Referencia Reference-No.	Ud. QTY	Descripción Description	Piloto Intermitente LED LED Sidemarker / Dir. Indicator Lamps	Tecnología LED LED Technology
P40.071.001	1	<p>Intermitente LED, lateral Categoría 6, reflectante y luz de posición integrado, conector 3p AMP SuperSeal, IP67, 12/24V, ECE R10</p> <p>LED Dir. Indicator Lamp, Cat. 6, integrated sidemarker lamp & reflex reflector, 3-pin AMP SuperSeal connector, IP67, 12/24V, ECE R10 approved</p>	 <p>Categoría 6</p>	
P40.069.001	1	<p>Intermitente LED, lateral Categoría 6, reflectante y luz de posición integrado, conector 3p AMP SuperSeal, IP67, 12/24V, ECE R10</p> <p>LED Dir. Indicator Lamp, Cat. 6, integrated sidemarker lamp & reflex reflector, 3-pin AMP SuperSeal connector, IP67, 12/24V, ECE R10 approved</p>	 <p>Categoría 6</p>	
P40.067.001	1	<p>Intermitente LED PRO-WING, Lateral Categoría 6, diseño atractivo y con guía de LED Integrada, tulipa de policarbonato translúcida, cable 0.5m, EMC Probado, 9-33V</p> <p>LED Dir. Indicator Lamp PRO-WING, Cat. 6, attractive design due to integrated light guide technology, clear glass optic, lens made of unbreakable polycarbonate, cable 0,5m, EMC appr., 9-33V</p>	 <p>Categoría 6</p>	
P40.002.901	1	<p>Intermitente LED PRO-PENNY, Lateral Categoría 5, Cable 0,5m, 12/24V, ADR, IP6K9K</p> <p>Lateral LED Dir. Indicator Lamp PRO-PENNY, cat. 5, cable 0,5m, 12/24V, ADR appr., IP6K9K</p>		
P40.002.911	1	<p>Intermitente LED PRO-PENNY, Tulipa transparente</p> <p>Lateral LED Dir. Indicator Lamp PRO-PENNY, dito, clear housing</p>	 <p>Categoría 5</p>	
P40.032.001	1	<p>Intermitente LED Categoría 5 y 6, Cable 0,5m, 9-33V</p> <p>LED Dir. Indicator Lamp, Cat. 5 and 6, cable 0,5m, 9-33V</p>	 <p>Categoría 5 + Categoría 6</p>	

Piloto Intermitente LED

LED Direction Indicator Lamp

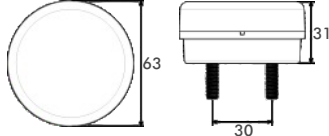

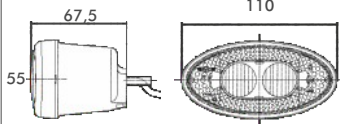
Referencia Reference-No.	Ud. QTY	Descripción Description	Piloto Intermitente LED LED Dir. Indicator Lamps	Tecnología LED LED Technology
P40.054.001	1	Intermitente LED PRO-MINI-RING , Trasero Categoría 2a, versión superficie, Cable 0,5m, 12/24V, ADR, IP6K9K LED Dir. Indicator Lamp PRO-MINI-RING , pendant version cat. 2a, cable 0,5m, 12/24V, ADR appr., IP6K9K	 Categoría 2a	
P40.054.501	1	Intermitente LED PRO-MINI-RING , Trasero Categoría 2a, versión empotrable, Cable 0,5m, 12/24V, ADR, IP6K9K LED Dir. Indicator Lamp PRO-MINI-RING , recessed version cat. 2a, cable 0,5m, 12/24V, ADR appr., IP6K9K	 Categoría 2a	
P40.057.001	1	Intermitente LED PRO-SQUARE Trasero Categoría 2a, Cable 0,5m, 12/24V, ADR-gepr., IP6K9K LED Dir. Indicator Lamp PRO-SQUARE cat. 2a, cable 0,5m, 12/24V, ADR appr., IP6K9K	 Categoría 2a	
P40.031.001	1	Intermitente LED Trasero óptica transparente FF y espejo brillante, Categoría 2a, Cable 0,5m, 12/24V LED Dir. Indicator Lamp, clear glas ff-optic with brilliant mirror, cat. 2a, cable 0,5m, 12/24V	 Categoría 2a	
P50.141.012 12V	1	Controlador LED PRO-CONTROL monitoriza la función Intermitencia		+ info. página 9.0.0
P50.141.024 24V	1	LED Control Gear PRO-CONTROL monitors the Direction Indicator function		LED Control Gear see also catalogue page 9.0

Piloto Intermitente LED

LED Direction Indicator Lamp



Referencia Reference-No.	Ud. QTY	Descripción Description	Piloto Intermitente LED/ Posición Frontal LED Dir. Indicator Lamps/ Front Position Lamp	Tecnología LED LED Technology
P40.287.911	1	Intermitente LED Frontal Cat. 1a, Cable 0,5m, a prueba de agua, versión superficie, para fijación horizontal o vertical. 12/24V - 3,5W LED Dir. Indicator/ Front Position Lamp, cat. 1a incl. cable 0,5m, potted version, for horizontal or vertical fixation, 12/24V - 3,5W	 Categoría 1a	
P40.057.911	1	Intermitente PRO-SQUARE Frontal Cat. 1a, Cable 0,5m, a prueba de agua, versión superficie, 12/24V LED Dir. Indicator/ Front Position Lamp PRO-SQUARE, cat. 1a incl. cable 0,5m, potted version, 12/24V	 Categoría 1a	
P40.058.911	1	Intermitente PRO-OVAL Frontal Cat. 1a, Cable 0,5m, a prueba de agua, versión superficie, 12/24V LED Dir. Indicator/ Front Position Lamp PRO-OVAL, cat. 1a incl. cable 0,5m, potted version, 12/24V	 Categoría 1a	
P40.042.001/1	1	Piloto Intermitente izquierdo Dir. Indicator Lamp, left	Volvo FM/FH O.E.: 82114506	
P40.042.011/1	1	Piloto Intermitente derecho Dir. Indicator Lamp, right	Volvo FM/FH O.E.: 82114500	
P50.141.012 12V	1	Controlador LED PRO-CONTROL monitoriza la función Intermitencia		+ info. página 9.0.0
P50.141.024 24V	1	LED Control Gear PRO-CONTROL monitors the Direction Indicator function		LED Control Gear see also catalogue page 9.0

NEW

ASPÖCK
IBERICA

PROPLAST

FAHRZEUGBELEUCHTUNG

www.aspock.com

Catálogo 2022/2023

3ª Luz de Freno LED

3rd Led Stop Lamp

Tipo: PRO-TWIN-CAN

Función: 3º Luz de Freno LED

Function: 3rd LED Stop Lamp

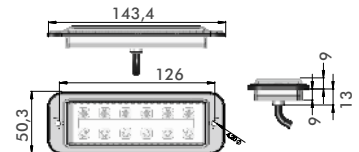
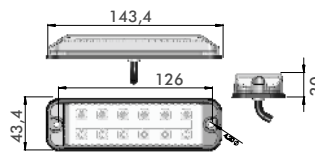

Referencia: Reference-No.	Ud. QTY	Izq. left	Dch. right	Luz Matrícula Numberplate- lamp	Descripción - Referencia O.E. Specification - O.E.-No.	Conector - Accesorios - Recambios Connector - Accessories - Spare Parts
P40.073.042 <i>Superficie Pendant</i>	1	■	■		Diseño compacto y exclusivo carcasa metalizada Tulipa: PMMA roja Conexión: 0,5m puntas abiertas Voltaje: 12/24 Volt Protección: IP6K9K Montaje: horizontal / vertical Homolog.: ECE ADR EMV Freno: 12V-1,0W / 24V-2,0W	
P40.073.742 <i>Empotrable Recessed</i>	1	■	■		Unique compact design metalized cover Lens: PMMA red Cable: 0,5m open end Voltage: 12/24 Volt Protection: IP6K9K Fixation: horizontal / vertical Homologation: ECE approved ADR approved EMC approved Stop: 12V-1,0W / 24V-2,0W	
P40.073.342 <i>Superficie Pendant</i>	1	■	■		Diseño compacto y exclusivo carcasa metalizada Tulipa: PMMA transparente Conexión: 0,5m puntas abiertas Voltaje: 12/24 Volt Protección: IP6K9K Montaje: horizontal / vertical Homolog.: ECE ADR EMV Freno: 12V-1,0W / 24V-2,0W	
P40.073.842 <i>Empotrable Recessed</i>	1	■	■		Unique compact design metalized cover Lens: PMMA clear Cable: 0,5m open end Voltage: 12/24 Volt Protection: IP6K9K Fixation: horizontal / vertical Homologation: ECE approved ADR approved EMC approved Stop: 12V-1,0W / 24V-2,0W	

Pilotos Intermitente

Direction Indicator Lamp



Referencia Reference-No.	Ud. QTY	Descripción Description	Referencia O.E. O.E. Part Number	Piloto Intermitente Dir. Indicator Lamps
P50.200.004/1	1	Piloto Intermitente derecho Dir. Indicator Lamp, right	Volvo FH, FM O.E.: 20826213-20498275	
P50.200.003/1	1	Piloto Intermitente izquierdo Dir. Indicator Lamp, left	Volvo FH, FM O.E.: 20826211-20498274	
P50.200.018/1	1	Piloto Intermitente derecho Dir. Indicator Lamp, right	Iveco Stralis O.E.: 41221029	
P50.200.019/1	1	Piloto Intermitente izquierdo Dir. Indicator Lamp, left	Iveco Stralis O.E.: 41221039	
P50.200.025/1	1	Piloto Intermitente Dcho./Izq. Dir. Indicator Lamp, right/left	RVI Premium O.E.: 5001847597	
P40.150.701	1	Portalámparas Bulb holder	RVI Premium O.E.: 5001845568	
P50.100.007	1	Piloto Intermitente Dcho./Izq. Dir. Indicator Lamp, right/left	Volvo FH/FH O.E.: 8191146	
P50.100.008	1	Piloto Intermitente Dcho./Izq. Dir. Indicator Lamp, right/left	Volvo FH/FH O.E.: 3981668	
P40.045.001/1	1	Piloto Intermitente izquierdo Dir. Indicator Lamp, right	Iveco Stralis O.E.: 42555042	
P40.045.011/1	1	Piloto Intermitente derecho Dir. Indicator Lamp, left	Iveco Stralis O.E.: 42555041	
P50.200.007	1	Piloto Intermitente derecho Dir. Indicator Lamp, right	Scania Serie 4 O.E.: 1385410	
P50.200.008	1	Piloto Intermitente izquierdo Dir. Indicator Lamp, left	Scania Serie 4 O.E.: 1387155	
P50.200.009/1	1	Piloto Intermitente derecho Dir. Indicator Lamp, right	Iveco Stralis O.E.: 41221040	
P50.200.010/1	1	Piloto Intermitente izquierdo Dir. Indicator Lamp, left	Iveco Stralis O.E.: 41221041	
P50.200.011/1	1	Piloto Intermitente Dcho./Izq. Dir. Indicator Lamp, right/left	Iveco Eurocargo O.E.: 504047573	
J80066000	1	Piloto Intermitente Dcho./Izq. Dir. Indicator Lamp, right/left	Volvo FH12 > 02 O.E.: 3981666	
P40.184.001	1	Piloto Intermitente Dcho./Izq. Dir. Indicator Lamp, right/left		 

3ª Luz de Freno LED

3rd LED Stop Lamp



Referencia Reference-No.	Ud. QTY	Descripción Description	Tecnología LED LED Technology
P40.052.042 24V	1	3ª Luz de freno LED PRO-STRIPE ECE II roja, cable 0,5m, 40 LEDs a prueba de agua, fijación horizontal, ADR, IP6K9K, 3W	
P40.052.242 12V	1	3rd LED Stop Lamp PRO-STRIPE ECE II , red, C. 0,5m, 40 LED fitted in a waterproof housing, for horizontal fixation, ADR-appr. IP6K9K, 3W	
P40.048.200	1	Kit de montaje PRO-STRIPE ECE incluye tornillos Mounting Kit PRO-STRIPE ECE incl. screws	
P40.026.412 24V	1	3ª Luz de Freno LED PRO-CAN XL roja, cable 0,5m, 18 LEDs, a prueba de agua, versión para fijación horizontal o. vertical, ADR IP67, 24/2W - 12V/2,5W	
P40.026.312 12V	1		
P40.026.432 24V	1	3ª Luz de Freno LED PRO-CAN XL roja, cable 0,5m, 18 LEDs, a prueba de agua, versión para fijación horizontal o. vertical, ADR IP67, 24/2W - 12V/2,5W 3rd LED Stop Lamp PRO-CAN XL , red, cable 0,5m, 18 LED fitted in a waterproof housing, for horizontal or vertical fixation, ADR-appr. IP67, 24V/2W - 12V/2,5W	
P40.606.002	1	3ª Luz de freno LED 12/24V versión empotrable, 18 LEDs, a prueba de agua, cable 0,5m 3rd LED-Stop Lamp 12/24V recessed version, 18 LED fitted in a waterproof housing, cable 0,5m	
P40.607.002	1	3ª Luz de freno LED 24V 28 LEDs de alto rendimiento, a prueba de agua, soporte muy resistente, incluye kit completo para instalar, IP54 3rd LED-Stop Lamp 24V 28 LED fitted in a waterproofed, solid plastic housing incl. Fixation Kit, IP54 appr.	
LÑ10100002	1	3ª Luz de freno LED 24V a prueba de agua, IP54 3rd LED-Stop Lamp 24V waterproofed, IP54 appr.	

3ª Luz de Freno LED

3rd LED Stop Lamp



Referencia Reference-No.	Ud. QTY	Descripción Description	Tecnología LED LED Technology
A31-9007-017	1	3ª Luz de freno LED 24V, 28 LEDs roja, cable 2m + conector ASS1 2p, a prueba de agua, ADR, IP69K 3rd LED Stop Lamp, 24V, 28 LEDs cabel 2m + 2 poles ASS1 connector ADR, IP54.	
A31-9009-007	1	3ª Luz de freno LED 12V, 28 LEDs roja, cable 2m, a prueba de agua, ADR, IP69K 3rd LED Stop Lamp, 24V, 28 LEDs cabel 2m + 2 poles ASS1 connector ADR, IP54.	
A31-8907-027	1	3ª Luz de freno LED 24V, 28 LEDs roja, cable 3m + conector ASS1 2p, a prueba de agua, ADR, IP54 3rd LED Stop Lamp, 24V, 28 LEDs cabel 3m + 2 poles ASS1 connector ADR, IP54.	
A31-8919-007	1	3ª Luz de freno LED 12V, roja, cable 1m + conector DC, a prueba de agua, ADR, IP69K 3rd LED Stop Lamp, 24V, cabel 1m + DC connector ADR, IP69K	
A31-8700-007	1	3ª Luz de freno LED 12V, roja, cable 0,2m a prueba de agua, IP54 3rd LED Stop Lamp, 12V, cabel 0,2m, IP54	
A31-8907-007	1	3ª Luz de freno LED 12V, roja, cable 2m + conector ASS1 2p, a prueba de agua, IP69K 3rd LED Stop Lamp, 24V, cabel 2m + ASS1 2poles connector ADR, IP69K	
A37-3764-007	1	Portamatrícula con 2 Luces de matrícula LED, cable 0.5m P&R 24V, sin 3ª Luz de Freno	
A37-3767-007	1	Portamatrícula con 2 Luces de matrícula LED, cable plano 0.5m + conector ASS2, 24V sin 3ª Luz de Freno	
A37-3760-017	1	Portamatrícula con 2 Luces de matrícula LED, cable 3.5m 24V Incluye 3ª Luz de Freno	

3ª Luz de Freno LED

3rd LED Stop Lamp



Referencia Reference-No.	Ud. QTY	Descripción Description	Tecnología LED LED Technology
A31-8920-007	1	<p>3º Luz de freno LED LINEPOINT I cable 0.5m, 12/24V, ADR, IP6K9K</p> <p>3rd LED Stop Lamp LINEPOINT I cable 0.5m, 12/24V, ADR, IP6K9K</p>	
A31-8910-017	1	<p>3º Luz de freno LED 24V, cable 0.5m, ADR, IP69K</p> <p>3rd LED Stop Lamp, 24V, cable 0.5m, ADR, IP69K.</p>	
A31-8907-017	1	<p>3º Luz de freno LED 24V, cable 0.5m, ADR, IP69K con bayoneta 2p ASS2</p> <p>3rd LED Stop Lamp, 24V, cable 1m + DC connector ADR, IP69K, with ASS2 bayonet 2p</p>	
A21-1000-034	1	<p>3º Luz de freno LED 12V, roja, cable 0,2m a prueba de agua, IP54</p> <p>3rd LED Stop Lamp, 12V, cable 0,2m, IP54</p>	
A15-5392-017	1	<p>Portamatricula Aspock</p>	

3ª Luz de Freno LED/Sistemas de Visión trasera

3rd LED Stop Lamp & Rear Vision System



Referencia Reference-No.	Ud. QTY	Descripción Description	Tecnología LUIS LUIS Technology
LU101063	1	<p>3ª Luz de freno universal con cámara integrada y monitor 3.5".1/4. Sensor de color Sony CCD 420 líneas de TV, Ángulo de visión 170 ° Fotosensibilidad 0 lux,6 LED para visión nocturna 10 m. 12V, 1.5W,180 mA, Temperatura de trabajo -30 / 70 °C, Ip68, formato de imagen PAL</p> <p>3rd LED Stop with camera integred and 3.5" monitor 1/4 Sony CCD color sensor, 420 TV lines, Viewing angle 170 ° Photosensitivity 0 lux, 6 x IR LEDs for night vision up to 10m Operating voltage 12V DC,Current consumption max. 180 mA Operating temperature -30 ° C to + 70 ° C, Protection class IP68 Picture format: PAL</p>	 <p>UNIVERSAL</p>
LU901064	1	<p>3ª Luz de freno universal con cámara integrada y monitor 7".1/4. Sensor de color Sony CCD 420 líneas de TV, Ángulo de visión 170 ° Fotosensibilidad 0 lux,6 LED para visión nocturna 10 m. 12V, 1.5W,180 mA, Temperatura de trabajo -30 / 70 °C, Ip68, formato de imagen PAL</p> <p>3rd LED Stop with camera integred and 7" monitor 1/4 Sony CCD color sensor, 420 TV lines, Viewing angle 170 ° Photosensitivity 0 lux, 6 x IR LEDs for night vision up to 10m Operating voltage 12V DC,Current consumption max. 180 mA Operating temperature -30 ° C to + 70 ° C, Protection class IP68 Picture format: PAL</p>	 <p>UNIVERSAL</p>
LU101066	1	<p>3ª Luz de freno con cámara integrada para Fiat Ducato Peugeot Boxer, Citroen Jumper. Sensor de color CMOS, ángulo de visión 170 °, Resolución 648 x 488 pixeles Fotosensibilidad 0.1 lux (día), 0 lux (con IR) 6 x LEDs IR para visión nocturna, 12V/2W máx. 180 mA Temperatura de funcionamiento -30 ° / 70 ° C, IP68, Micrófonos integrados, formato de imagen PAL</p> <p>3rd LED Stop with camera integred for Fiat Ducato & Peugeot Boxer, CMOS color sensor, Viewing angle 170 Resolution 648 x 488 pixels Photosensitivity 0.1 lux 6 x IR LEDs for night vision, 12V. 180 mA, Operating temperature -30 ° C to + 70 ° C, Ip68, Integrated microphones, Picture format: PAL.</p>	 <p>CITR. JUMPER/FIAT DUCADO/PEUG. BOXER</p>
LU101067	1	<p>3ª Luz de freno con cámara integrada para VW Crafter y MB Sprinter 2006, Sensor de color CMOS con 700 líneas de TV, Ángulo de visión 120 °, Resolución 510 x 492 pixeles Fotosensibilidad 0.1 lux (día), 0 lux LED IR para visión nocturna, Temperatura de trabajo -30 ° / 70 ° C, IP69k, Protección contra vibraciones 10G Consumo de energía 3 W máx., Formato de imagen: PAL</p> <p>3rd LED Stop with camera integred for VW Crafter & MB Sprinter 2006, CMOS color sensor with 700 TV lines Viewing angle 120, Resolution 510 x 492 pixels Photosensitivity 0.1 lux (day), 0 lux (with IR) IR LEDs for night vision. Operating temperature -30 ° C to + 70 ° C, Protection class IP69K, Vibration protection 10G, Power consumption 3W max., Picture format: PAL</p>	 <p>VW CRAFTER / MB SPRINTER</p>
LU101068	1	<p>3ª Luz de freno con cámara integrada para Iveco Daily, Sensor de color CMOS con 700 líneas de TV Ángulo de visión 170 °, Resolución 510 x 492 pixeles, Fotosensibilidad 0.1 lux (día), 0 lux (con IR), LED IR para visión nocturna, Temperatura de trabajo -30°/70 ° C IP69k, Protección contra vibraciones 10G, Consumo de energía 3 W máx., Formato de imagen: PAL</p> <p>3rd LED Stop with camera integred for Iveco Daily, CMOS color sensor with 700 TV lines, Viewing angle 170 ° Resolution 510 x 492 pixels Photosensitivity 0.1 lux (day), 0 lux (with IR), IR LEDs for night vision, Operating temperature -30° to + 70 ° C, Protection class IP69k, Vibration protection 10G Power consumption 3 W max., Picture format: PAL</p>	 <p>IVECO DAILY</p>

3ª Luz de Freno LED/Sistemas de Visión trasera

3rd LED Stop Lamp & Rear Vision System





Referencia Reference-No.	Ud. QTY	Descripción Description	Tecnología LUIS LUIS Technology
LU101069	1	<p>3ª Luz de freno con cámara integrada para VW Crafter Man TGE 2017. Ángulo de visión 120° Visión nocturna, 1/3 CMOS-Sensor, 700 líneasTV, Temperatura de trabajo -30°/70°C, IP69K, 12V</p> <p>3rd LED Stop camera for VW Crafter & MAN TGE 2017, Viewing angle of 120°, Night vision up to 10m. 1/3 CMOS-Sensor, 700 lines TV, Applicable from approx. -30°/70°C, IP69K, 12V</p>	 VW CRAFTER / MAN TGE 2017
LU101073	1	<p>3ª Luz de freno con cámara integrada para Renault Master, Opel Movano, Nissan Nv400, Resolución 700 TV- líneas, sistema PAL, IP69k</p> <p>3rd LED Stop with camera integred for Renault Master, Opel Movano, Nissan Nv400 Resolution 700TV-lines, PAL System, IP69k</p>	 RVI MASTER
LU500130	1	<p>Kit de visión trasera BASIC LUIS, incluye cámara con 20m de cable y Monitor 7", datos técnicos: Cámara: 1/3 CMOS-Color-Sensor, Ángulo de visión 80° H / 65° V / 105° D, Resolución 600 líneas de TV con sistema PAL, LED infrarrojos para visión nocturna, Temperatura de trabajo -30°/ 70° C, IP68, 9-32 V Monitor: Display: 7", Resolución 800 x 480 pixel, Panel Digital A+, Altavoz integrado, 2 Entradas de video Cambio automático PAL / NTSC, 9-24 V</p> <p>LUIS BASIC System camera, included camera with cable 20m + Monitor 7", Datasheet: Camera: 1/3 CMOS-Colour-Sensor, Resolution 600 TV-lines with PAL System, Operating temperature -30°C to +70°C, IP68 IR LED on, 9-32 V Monitor: Display: 7", Resolution 800 x 480 Pixel, Digital A+ panel, Integrated speaker, 2 Video Inputs Reverse trigger, Operating Temperature -30°C to +70°C, 9-24 V, R10</p>	 KIT BÁSICO
LU910130	1	<p>Kit de visión trasera PROFESSIONAL LUIS, incluye cámara con 20m de cable y Monitor 7", datos técnicos: Cámara: 1/3 SONY CCD-Color-Sensor, Ángulo de visión 80°H / 55° V / 100° D, Resolución 600 líneas de TV con sistema PAL, LED infrarrojos para visión nocturna, Temperatura de trabajo -40°/ 85°C, IP69K, 9-32 V, calefacción integrada, R10 Monitor: Pantalla 7"HD, Resolución 1280 x 600 pixel, Panel Digital A+, Altavoz integrado, función espejo, 3 Entradas de video (señal AHD), temp.-30° / 70° C 9-32 V</p> <p>LUIS PROFESSIONAL System camera, included camera with cable 20m + Monitor 7", Datasheet: Camera: 1/3 CMOS-Colour-Sensor, Resolution 600 TV-lines with PALSystem, Operating temperature -30/70°C, IP68, 9-32 V Monitor: Display: 7", Resolution 1.280 x 600 Pixel, Digital A+ panel, Brightness of 400cd/m2, Integrated speaker, 3 Video Inputs Operating Temperature -30C /70°C, 9-32 V</p>	 KIT PROFESIONAL
LU002099	1	<p>Kit completo de serpentinas y conectores LUIS especial remolques, con cable de 20m mas los conectores de los macho y hembra correspondientes.</p> <p>Complete kit of special LUIS streamers and connectors trailers, with 20m cable plus the connectors of the corresponding male and female.</p>	

Sistemas de Visión trasera

Rear Vision System



Referencia Reference-No.	Ud. QTY	Descripción Description	Tecnología LUIS LUIS Technology
LU000555	1	<p>Kit de Visión trasera WIRELESS LUIS incluye cámara y monitor con sistema de radio digital. datos técnicos: Cámara: Sensor de color CMOS SONY 1/4, Resolución 640 x 480 VGA, Ángulo de visión 135° (HI), Señal de video wireless 2.4G Tecnología digital de encriptación para asegurar la no interferencia, Visión Nocturna: 10m Temperatura de trabajo 0°C a +60°C Micrófono integrado (opcional), Ip68, 12-24V Monitor: TFT-Monitor 7" a color, Resolución 800 x 480 Pixel, 2 entradas señal video inalámbrica 2.4G con 14 puntos de frecuencia 2412MHz ~ 2484MHz, Tecnología digital de encriptación para asegurar la no interferencia 4 Entradas de video Digital Wireless, 1 Entrada de Audio, 12/24V, Temperatura trabajo -20°/70°C</p> <p>Kit wireless system camera, included radio digital camera and video digital Monitor. Data sheet: Camera: SONY CCD-Colour-Sensor, § View angle 65° H / 45° V / 80° D, Resolution 640 x 480 VGA TV System PAL, 2.4G wireless video signal, Digital wireless encryption technology to ensure anti-interference Operating temperature -30°C to +70°C, IP69k, 9-32V Monitor: Colour TFT-Monitor Display 7", Resolution 800 x 480 Pixel, 2.4G wireless video signal input (14 signal frequency points) 2,412MHz ~ 2,484MHz Integrated speaker, Digital wireless encryption technology to ensure anti-interference, 2 Digital wireless video inputs (1 Audio Input), Working temperature -30°C to +70°C 12/ 24 V</p>	 <p>KIT WIRELESS</p>
LU300360	1	<p>Kit de visión trasera 360° KBF, incluye 4 cámaras con 20m de cable, Monitor 7" y centralita ECU. Cámara: 1/3 Color CCD, Angulo de visión 180° H / 65° V / 145° V, Resolución 640 x 480, señal de video NTSC, Ip69, 12/24V, Temperatura de trabajo -40° / 85 °C Temperatura de trabajo -30°/ 70° C, IP68, 9-32 V Monitor: Display: 7", Resolución 800 x 480 pixel, Panel Digital A+, Altavoz integrado, 2 Entradas de video Cambio automático PAL / NTSC, 9-24 V</p> <p>360° LUIS Video System camera, included camera + Monitor 7", Datasheet: Camera: 1/3 SONY CCD-Colour-Sensor, Viewing angle 65° H / 45° V / 80° D, Resolution 640X480 VGA, TV PAL System 2.4G wireless video signal, Digital wireless encryption technology to ensure anti-interference, Operating temperature -30°C to +70°C IP69k, 9-32 V Monitor: Colour TFT display 7", Resolution 800 x 480 Pixel, 2.4G wireless video signal input (14 signal frequency points) 2,412MHz ~ 2,484MHz, Integrated speaker, Digital wireless encryption technology to ensure anti-interference, 2 Digital wireless video inputs (1 Audio Input) Working temperature -30°C to +70°C, 12/24V</p>	 <p>KIT 360° KFB</p>
LU101085	1	<p>Transmisor profesional WIFI LUIS, transfiere la señal de video de cualquier cámara con cables LUIS a su teléfono inteligente o tablet (Android /iOS), carcasa robusta, resistente al polvo y al agua IP69K, conexión mediante la aplicación gratuita LUIS SK WIFI</p> <p>WIFI LUIS professional transmitter, transfers the Video signal from any camera with LUIS cables to your smartphone or tablet (Android / iOS), robust housing, water and dust resistant IP69K, connection through the free application LUIS SK WIFI</p>	

Sistema Asistencia Ángulo Muerto LUIS

Turn Detect LUIS

Referencia Reference-No.	Ud. Descripción QTY Description	Tecnología LUIS LUIS Technology
		
<p>LU420400.PRO7.3</p>	<p>LUIS ofrece sistemas de asistencia de giro altamente innovadores y efectivos. Los sistemas han sido desarrollados para el equipamiento de serie y también, explícitamente, para reequipamiento. El TURN DETECT® funciona con cámara y software. El software de TURN DETECT® detecta peatones y ciclistas en la zona de peligro del vehículo y advierte solo si hay riesgo de colisión.</p>  <p> › Asistente de giro basado en cámara y software › Cámara gran angular con ángulo de cobertura muy grande, cámara frontal opcional › Advertencia óptica (cuadro rojo) y acústica (timbre) para personas en la zona de peligro y riesgo de colisión inminente › Activación por velocidad u otros factores desencadenantes </p>	<p>Advertencia de dos etapas: (1) Cuadro rojo en caso de persona en el área de peligro (2) Cuadro rojo y advertencia acústica en caso de persona en el área de peligro y el vehículo inicia la maniobra de giro (por ejemplo, giro de volante o luz intermitente) › Detección de ciclistas en segunda fila › Tensión de funcionamiento 9 a 32 V</p> <p> › Asistente de giro basado en cámara y software › Cámara gran angular con ángulo de cobertura muy grande, cámara frontal opcional › Advertencia óptica (cuadro rojo) y acústica (timbre) para personas en la zona de peligro y riesgo de colisión inminente › Activación por velocidad u otros factores desencadenantes </p>

Pilotos Posición Lateral LED	LED End Outline Marker Lamps	3.0	- 3.9
Pilotos Posición Lateral	End Outline Marker Lamps	3.10	- 3.20
Pilotos Gálbos Frontales LED	LED Front Position Lamps/	3.21	- 3.42
Pilotos Gálbos Traseros LED	LED Rear Position Lamps		
Gálbos Universales	Universal Position Lamps	3.43	



Pilotos Posición LED

LED End Outline Marker Lamp

Tipo: PRO-SUPER-JET LED con Luz Lateral



Referencia: Reference-No.	Ud. QTY	Descripción Description	Piloto Posición Lateral LED LED End Outline Marker Lamps	Tecnología LED12V/24V LED Technology 12V/24V
P40.004.014 Izquierdo/left	1	<p>Piloto posición lateral LED PRO-SUPER-JET izquierdo, con guía de LED y tecnología de óptica de espejo, lente roja / blanca / ámbar, soporte flexible, cubierta de plástico de la lente, cable de 1,75 m, ADR. IP6K9K, 12V-1W, 24V-2W</p> <p>LED End Outline Marker PRO-SUPER-JET left, Light Guide Technology with Mirror Optics, Lens red/white/amber, flex bracket, plastic-covered Lens, cable 1,75m, ADR appr. IP6K9K, 2V-1W, 24V-2W</p>		
P40.004.015 Derecho/right	1	<p>Piloto posición lateral LED PRO-SUPER-JET derecho, con guía de LED y tecnología de óptica de espejo, lente roja / blanca / ámbar, soporte flexible, cubierta de plástico de la lente, cable de 1,75 m, ADR. IP6K9K, 12V-1W, 24V-2W</p> <p>LED End Outline Marker PRO-SUPER-JET right, Light Guide Technology with Mirror Optics, Lens red/white/amber, flex bracket, plastic-covered Lens, cable 1,75m, ADR appr. IP6K9K, 2V-1W, 24V-2W</p>		
P40.004.314 Izquierdo/left	1	<p>Piloto posición lateral LED PRO-SUPER-JET izquierdo, con guía de LED y tecnología de óptica de espejo, lente roja / blanca / ámbar, soporte flexible, cubierta de plástico de la lente, cable de 1,75 m P&R, ADR. IP6K9K, 12V-1W, 24V-2W</p> <p>LED End Outline Marker PRO-SUPER-JET left, Light Guide Technology with Mirror Optics, Lens red/white/amber, flex bracket, plastic-covered Lens, cable 1,75m + P&R connector, ADR appr. IP6K9K, 12V-1W, 24V-2W</p>		
P40.004.315 Derecho/right	1	<p>Piloto posición lateral LED PRO-SUPER-JET derecho, con guía de LED y tecnología de óptica de espejo, lente roja / blanca / ámbar, soporte flexible, cubierta de plástico de la lente, cable de 1,75 m P&R, ADR. IP6K9K, 12V-1W, 24V-2W</p> <p>LED End Outline Marker PRO-SUPER-JET left, Light Guide Technology with Mirror Optics, Lens red/white/amber, flex bracket, plastic-covered Lens, cable 1,75m + P&R connector, ADR appr. IP6K9K, 12V-1W, 24V-2W</p>		

Pilotos Posición LED

LED End Outline Marker Lamp

Tipo: PRO-SUPER-JET LED con Luz Lateral



Referencia: Reference-No.	Ud. QTY	Descripción Description	Piloto Posición Lateral LED LED End Outline Marker Lamps	Tecnología LED12V/24V LED Technology 12V/24V
P40.005.004	1	<p>Piloto posición lateral LED PRO-SUPER-JET izquierdo, con guía de LED y tecnología de óptica de espejo, lente roja / blanca / ámbar, soporte flexible, cubierta de plástico de la lente, cable de 1,75 m, ADR. IP6K9K, 12V-1W, 24V-2W</p> <p>LED End Outline Marker PRO-SUPER-JET, Light Guide Technology with Mirror Optics, Lens red/white/amber, flex short bracket, plastic-covered Lens, cable 1,75m, ADR appr. IP6K9K, 12V-1W, 24V-2W</p>		
P40.005.304	1	<p>Piloto posición lateral LED PRO-SUPER-JET izquierdo, con guía de LED y tecnología de óptica de espejo, lente roja / blanca / ámbar, soporte flexible, cubierta de plástico de la lente, cable de 1,75 m P&R, ADR. IP6K9K 12V-1W, 24V-2W</p> <p>LED End Outline Marker PRO-SUPER-JET, Light Guide Technology with Mirror Optics, Lens red/white/amber, flex short bracket, plastic-covered Lens, cable 1,75m + P&R connector, ADR appr. IP6K9K, 12V-1W, 24V-2W</p>		
P40.006.004	1	<p>Piloto posición lateral LED PRO-SUPER-JET izquierdo, con guía de LED y tecnología de óptica de espejo, lente roja / blanca / ámbar, soporte flexible, cubierta de plástico de la lente, cable de 1,75 m, ADR. IP6K9K, 12V-1W, 24V-2W</p> <p>LED End Outline Marker PRO-SUPER-JET, Light Guide Technology with Mirror Optics, Lens red/white/amber, flex housing, plastic-covered Lens, cable 1,75m, ADR appr. IP6K9K, 12V-1W, 24V-2W</p>		
P40.006.304	1	<p>Piloto posición lateral LED PRO-SUPER-JET izquierdo, con guía de LED y tecnología de óptica de espejo, lente roja / blanca / ámbar, soporte flexible, cubierta de plástico de la lente, cable de 1,75 m P&R, ADR. IP6K9K 12V-1W, 24V-2W</p> <p>LED End Outline Marker PRO-SUPER-JET, Light Guide Technology with Mirror Optics, Lens red/white/amber, flex housing, plastic-covered Lens, cable 1,75m + P&R connector, ADR appr. IP6K9K, 12V-1W, 24V-2W</p>		

Pilotos Posición LED

LED End Outline Marker Lamp

Tipo: PRO-SUPER-JET LED con Luz Lateral



Referencia: Reference-No.	Ud. QTY	Descripción Description	Piloto Posición Lateral LED LED End Outline Marker Lamps	Tecnología LED12V/24V LED Technology 12V/24V
P40.007.014	1	<p>Piloto posición lateral LED PRO-SUPER-JET izquierdo, con guía de LED y tecnología de óptica de espejo, lente roja / blanca / ámbar, cable de 1,75m, ADR, EMC, IP6K9K, 12/24V</p> <p>LED End Outline Marker PRO-SUPER-JET, Light Guide Technology with Mirror Optics, Lens red/white/amber, cable 1,75m, ADR, EMC appr. IP6K9K, 12/24V</p>		
P40.007.024	1	<p>Piloto posición lateral LED PRO-SUPER-JET izquierdo, con guía de LED y tecnología de óptica de espejo, soporte recto flexible, lente roja / blanca / ámbar, cable de 1,75m, ADR, EMC, IP6K9K, 12/24V</p> <p>LED End Outline Marker PRO-SUPER-JET, Light Guide Technology with Mirror Optics, Lens red/white/amber, flex short bracket, cable 1,75m, ADR, EMC appr. IP6K9K, 12/24V</p>		

Pilotos Posición LED

LED End Outline Marker Lamp

Tipo: PRO-JET



Referencia Reference-No.	Ud. QTY	Descripción Description	Piloto Posición Lateral LED LED End Outline Marker Lamps	Tecnología LED 12V/24V LED Technology 12V/24V
P40.001.004	2	<p>Piloto posición lateral LED PRO-JET con tecnología FF, tulipa roja/blanca, a prueba de agua, IP6K9K, cable 1.75m, ADR, 12V-0,8W, 24V-1,5W</p> <p>LED End Outline Marker PRO-JET FF-Technology, Lens red/white, lamp complete waterproof casted, cable 1,75m, 12V-0,8W, 24V-1,5W, ADR approved IP6K9K</p>		
P40.001.304	2	<p>Piloto posición lateral LED PRO-JET con tecnología FF, tulipa roja/blanca, a prueba de agua, IP6K9K, cable 1.75m, con Conector P&R, ADR, 12V-0,8W, 24V-1,5W</p> <p>LED End Outline Marker PRO-JET FF-Technology, Lens red/white, lamp complete waterproof casted, cable 1,75m + P&R, 12V-0,8W, 24V-1,5W, ADR approved IP6K9K</p>		
P40.001.024	2	<p>Piloto posición lateral LED PRO-JET con tecnología FF, tulipa roja/blanca, a prueba de agua, soporte recto flexible IP6K9K, cable 1.75m, ADR, 12V-0,8W, 24V-1,5W</p> <p>LED End Outline Marker PRO-JET FF-Technology, Lens red/white, lamp complete waterproof casted, flex. bracket, cable 1,75m, 12V-0,8W, 24V-1,5W, ADR approved IP6K9K</p>		
P40.001.324	2	<p>Piloto posición lateral LED PRO-JET con tecnología FF, tulipa roja/blanca, a prueba de agua, soporte recto flexible IP6K9K, cable 1.75m con conector P&R, ADR, 12V-0,8W, 24V-1,5W</p> <p>LED End Outline Marker PRO-JET FF-Technology, Lens red/white, lamp complete waterproof casted, flex. bracket, cable 1,75m P&R,, 12V-0,8W, 24V-1,5W, ADR approved IP6K9K</p>		

Pilotos Posición LED

LED End Outline Marker Lamp

Tipo: PRO-JET



Referencia Reference-No.	Ud. QTY	Descripción Description	Piloto Posición Lateral LED LED End Outline Marker Lamps	Tecnología LED 12V/24V LED Technology 12V/24V
P40.001.204	2	<p>Piloto posición lateral LED PRO-JET con tecnología FF, tulipa roja/blanca, a prueba de agua, IP6K9K, cable plano 0,5m, ADR, 12V-0,8W, 24V-1,5W</p> <p>LED End Outline Marker PRO-JET FF-Technology, Lens red/white, lamp complete waterproof casted, flatcable 0,5m, 12V-0,8W, 24V-1,5W, ADR approved IP6K9K</p>		
P40.001.704	2	<p>Piloto posición lateral LED PRO-JET con tecnología FF, tulipa roja/blanca, a prueba de agua, IP6K9K, con conector AMP 2p Superseal, ADR, 12V-0,8W, 24V-1,5W</p> <p>LED End Outline Marker PRO-JET FF-Technology, Lens red/white, lamp complete waterproof casted, AMP SuperSeal connector, 12V-0,8W, 24V-1,5W, ADR approved IP6K9K</p>		
P40.001.224	2	<p>Piloto posición lateral LED PRO-JET con tecnología FF, tulipa roja/blanca, a prueba de agua, soporte recto flexible IP6K9K, cable plano 0.5m, ADR, 12V-0,8W, 24V-1,5W</p> <p>LED End Outline Marker PRO-JET FF-Technology, Lens red/white, lamp complete waterproof casted, flex. bracket, flatcable 0,5m, 12V-0,8W, 24V-1,5W, ADR approved IP6K9K</p>		
P40.001.724	2	<p>Piloto posición lateral LED PRO-JET con tecnología FF, tulipa roja/blanca, a prueba de agua, soporte recto flexible IP6K9K, conector AMP Superseal, ADR, 12V-0,8W, 24V-1,5W</p> <p>LED End Outline Marker PRO-JET FF-Technology, Lens red/white, lamp complete waterproof casted, flex. bracket, AMP SuperSeal connector, 12V-0,8W, 24V-1,5W, ADR approved IP6K9K</p>		

Pilotos Posición LED

LED End Outline Marker Lamp

Tipo: LED PRO-SUPERPOINT III



Referencia: Reference-No.	Ud. QTY	Descripción Description	Piloto Posición Lateral LED LED End Outline Marker Lamps	Tecnología LED12V/24V LED Technology 12V/24V
P40.010.004	2	Piloto lateral posición LED SUPERPOINT III con tecnología FF, tulipa policarbonato de color rojo/blanco/ámbar, soporte de goma flexible, ADR, cable 1,75m, 12V-0,5W, 24V-1W LED End Outline Marker SUPERPOINT III in FF-Technology Lens red/white/amber, flex bracket, Lens made in PC, ADR appr., cable 1,75m, 12V-0,5W, 24V-1W		
P40.011.004	2	Piloto lateral posición LED SUPERPOINT III con tecnología FF, tulipa policarbonato de color rojo/blanco/ámbar, base de goma flexible, ADR, cable 1,75m, 12V-0,5W, 24V-1W LED End Outline Marker SUPERPOINT III in FF-Technology Lens red/white/amber, flex housing, Lens made in PC, ADR appr., cable 1,75m, 12V-0,5W, 24V-1W		
P40.012.004	2	Piloto lateral posición LED SUPERPOINT III con tecnología FF, tulipa policarbonato de color rojo/blanco/ámbar, soporte recto de goma flexible, ADR, cable 1,75m, 12V-0,5W, 24V-1W LED End Outline Marker SUPERPOINT III in FF-Technology Lens red/white/amber, flex bracket, Lens made in PC, ADR appr., cable 1,75m, 12V-0,5W, 24V-1W		
P40.013.004	2	Piloto lateral posición LED SUPERPOINT III con tecnología FF, tulipa policarbonato de color rojo/blanco/ámbar, soporte recto de goma flexible, ADR, cable 1,75m, 12V-0,5W, 24V-1W LED End Outline Marker SUPERPOINT III in FF-Technology Lens red/white/amber, flex short bracket, Lens made in PC, ADR cable 1,75m, 12V-0,5W, 24V-1W		
P40.010.105	2	Portalámparas LED con cable 1,75m, 12V-0,5W / 24V-1W LED Unit incl. cable 1,75m, 12V-0,5W / 24V-1W		
P40.010.104	10	Tulipa policarbonato rojo/blanco/ámbar Lens made in PC, red/white/amber		

Pilotos Posición LED

LED End Outline Marker Lamp

Tipo: LED PRO-SUPERPOINT III



Referencia: Reference-No.	Ud. QTY	Descripción Description	Piloto Posición Lateral LED LED End Outline Marker Lamps	Tecnología LED12V/24V LED Technology 12V/24V
P40.010.304	2	<p>Piloto lateral posición LED SUPERPOINT III con tecnología FF, tulipa policarbonato de color rojo/blanco/ámbar, soporte de goma flexible, ADR, cable 1,75m P&R, 12V-0,5W, 24V-1W</p> <p>LED End Outline Marker SUPERPOINT III in FF-Technology Lens red/white/amber, flex bracket, Lens made in PC, ADR appr., cable 1,75m + P&R connector, 12V-0,5W, 24V-1W</p>		
P40.011.304	2	<p>Piloto lateral posición LED SUPERPOINT III con tecnología FF, tulipa policarbonato de color rojo/blanco/ámbar, base de goma flexible, ADR, cable 1,75m P&R, 12V-0,5W, 24V-1W</p> <p>LED End Outline Marker SUPERPOINT III in FF-Technology Lens red/white/amber, flex housing, Lens made in PC, ADR appr., cable 1,75m + P&R connector, 12V-0,5W, 24V-1W</p>		
P40.012.304	2	<p>Piloto lateral posición LED SUPERPOINT III con tecnología FF, tulipa policarbonato de color rojo/blanco/ámbar, soporte recto de goma flexible, ADR, cable 1,75m, 12V-0,5W, 24V-1W</p> <p>LED End Outline Marker SUPERPOINT III in FF-Technology Lens red/white/amber, flex bracket, Lens made in PC, ADR appr., cable 1,75m + P&R connector, 12V-0,5W, 24V-1W</p>		
P40.013.304	2	<p>Piloto lateral posición LED SUPERPOINT III con tecnología FF, tulipa policarbonato de color rojo/blanco/ámbar, soporte recto goma flexible, ADR, cable 1,75m P&R, 12V-0,5W, 24V-1W</p> <p>LED End Outline Marker SUPERPOINT III in FF-Technology Lens red/white/amber, flex short bracket, Lens made in PC, ADR appr., cable 1,75m + P&R connector, 12V-0,5W, 24V-1W</p>		
P40.010.105	2	<p>Portalámparas LED con cable 1,75m P&R, 12V-0,5W / 24V-1W LED Unit incl. cable 1,75m + P&R connector, 12V-0,5W / 24V-1W</p>		
P40.010.104	10	<p>Tulipa policarbonato rojo/blanco/ámbar Lens made in PC, red/white/amber</p>		

Pilotos Posición LED

LED End Outline Marker Lamp

Tipo: LED PRO-SUPERPOINT III



Referencia: Reference-No.	Ud. QTY	Descripción Description	Piloto Posición Lateral LED LED End Outline Marker Lamps	Tecnología LED12V/24V LED Technology 12V/24V
P40.010.214 Izquierdo/left	1	<p>Piloto lateral posición LED SUPERPOINT III con tecnología FF, tulipa policarbonato de color rojo/blanco/ámbar, soporte de goma flexible, ADR, cable plano 1,75m, 12V-0,5W, 24V-1W</p> <p>LED End Outline Marker SUPERPOINT III in FF-Technology, left, Lens red/white/amber, flex bracket, Lens made in PC, ADR appr., flat cable 0,5m, 12V-0,5W, 24V-1W</p>		
P40.010.215 Derecho/right	1	<p>Piloto lateral posición LED SUPERPOINT III con tecnología FF, tulipa policarbonato de color rojo/blanco/ámbar, soporte de goma flexible, ADR, cable plano 1,75m, 12V-0,5W, 24V-1W</p> <p>LED End Outline Marker SUPERPOINT III in FF-Technology, right, Lens red/white/amber, flex bracket, Lens made in PC, ADR appr., flat cable 0,5m, 12V-0,5W, 24V-1W</p>		
FA42-4000-001	1	<p>Piloto lateral posición LED rojo/blanco, IP67, soporte goma flexible, cable 0.2m 10/30V</p> <p>LED End Outline Marker Lens red/white, flex bracket, Ip67 approved, cable 0.2m 10/30V</p>		

Pilotos Posición LED

LED End Outline Marker Lamp

Tipo: LED PRO-SUPERPOINT III ECO



Referencia: Reference-No.	Ud. QTY	Descripción Description	Piloto Posición Lateral LED LED End Outline Marker Lamps	Tecnología LED12V/24V LED Technology 12V/24V
P40.010.924	2	<p>Piloto lateral posición LED SUPERPOINT III ECO, tulipa policarbonato de color rojo/NEGRO/ámbar, soporte de goma flexible, ADR, cable 0,5m 12V-0,5W, 24V-1W</p> <p>LED End Outline Marker SUPERPOINT III ECO Lens red/BLACK/amber, flex bracket, Lens made in PC, ADR appr., cable 0,5m, 12V-0,5W, 24V-1W</p>		
P40.011.904	2	<p>Piloto lateral posición LED SUPERPOINT III ECO, tulipa policarbonato de color rojo/blanco/ámbar, base de goma flexible, ADR, cable 0,5m 12V-0,5W, 24V-1W</p> <p>LED End Outline Marker SUPERPOINT III ECO Lens red/white/amber, flex housing, Lens made in PC, ADR appr., cable 0,5m, 12V-0,5W, 24V-1W</p>		
P40.012.944	2	<p>Piloto lateral posición LED SUPERPOINT III ECO, tulipa policarbonato de color rojo/blanco/ámbar, soporte recto de goma flexible, ADR, cable 0,5m, 12V-0,5W, 24V-1W</p> <p>LED End Outline Marker SUPERPOINT III ECO Lens red/white/amber, flex bracket, Lens made in PC, ADR appr., cable 0,5m, 12V-0,5W, 24V-1W</p>		
P40.013.904	2	<p>Piloto lateral posición LED SUPERPOINT III ECO, tulipa policarbonato de color rojo/blanco/ámbar, soporte recto goma flexible, ADR, cable 0,5m 12V-0,5W, 24V-1W</p> <p>LED End Outline Marker SUPERPOINT III ECO Lens red/white/amber, flex short bracket, Lens made in PC, ADR cable 0,5m, 12V-0,5W, 24V-1W</p>		

Pilotos Posición LED

LED End Outline Marker Lamp

Tipo: LED SUPERPOINT IV ASPÖCK



Referencia: Reference-No.	Ud. QTY	Descripción Description	Piloto Posición Lateral LED LED End Outline Marker Lamps	Tecnología LED12V/24V LED Technology 12V/24V
A31-3104-007 Izquierdo	1	<p>Piloto lateral posición LED SUPERPOINT IV, tulipa incolora, rojo/blanca/ámbar soporte goma flexible, ADR, cable 2m + conector P&R 12V-0,5W, 24V-1W, IP69K</p> <p>LED End Outline Marker SUPERPOINT IV Lens red/white/amber, flex bracket, Lens made in PC, ADR appr. cable 2m + P&R connector 12V-0,5W, 24V-1W</p>	 <p>Salida cable exterior</p>	
A31-3104-017 Derecho	1	<p>Piloto lateral posición LED SUPERPOINT IV, tulipa incolora, rojo/blanca/ámbar soporte goma flexible, ADR, cable 2m + conector P&R 12V-0,5W, 24V-1W, IP69K</p> <p>LED End Outline Marker SUPERPOINT IV Lens red/white/amber, flex bracket, Lens made in PC, ADR appr. cable 2m + P&R connector 12V-0,5W, 24V-1W</p>	 <p>Salida cable exterior</p>	
A31-3105-007 Izquierdo	1	<p>Piloto lateral posición LED SUPERPOINT IV, tulipa incolora, rojo/blanca/ámbar soporte goma flexible, ADR, cable 2m + conector ASS2 12V-0,5W, 24V-1W, IP69K</p> <p>LED End Outline Marker SUPERPOINT IV Lens red/white/amber, flex bracket, Lens made in PC, ADR appr. cable 2m + ASS2 connector 12V-0,5W, 24V-1W</p>	 <p>Salida cable exterior</p>	
A31-3106-007 Derecho	1	<p>Piloto lateral posición LED SUPERPOINT IV, tulipa incolora, rojo/blanca/ámbar soporte goma flexible, ADR, cable 2m + conector ASS2 12V-0,5W, 24V-1W, IP69K</p> <p>LED End Outline Marker SUPERPOINT IV Lens red/white/amber, flex bracket, Lens made in PC, ADR appr. cable 2m + ASS2 connector 12V-0,5W, 24V-1W</p>	 <p>Salida cable exterior</p>	

Pilotos Posición LED

LED End Outline Marker Lamp

Tipo: LED SUPERPOINT IV ASPÖCK



Referencia: Reference-No.	Ud. QTY	Descripción Description	Piloto Posición Lateral LED LED End Outline Marker Lamps	Tecnología LED12V/24V LED Technology 12V/24V
A31-3103-034 Izquierdo	1	<p>Piloto lateral posición LED SUPERPOINT IV, tulipa incolora, rojo/blanca/ámbar soporte goma flexible, ADR, cable 1m + con. 2p Superseal 12V-0,5W, 24V-1W, IP69K</p> <p>LED End Outline Marker SUPERPOINT IV Lens red/white/amber, flex bracket, Lens made in PC, ADR appr. cable 2m + 2p. Superseal connector 12V-0,5W, 24V-1W</p>	 Salida cable interior	
A31-3102-034 Derecho	1	<p>Piloto lateral posición LED SUPERPOINT IV, tulipa incolora, rojo/blanca/ámbar soporte goma flexible, ADR, cable 1m + con. 2p Superseal 12V-0,5W, 24V-1W, IP69K</p> <p>LED End Outline Marker SUPERPOINT IV Lens red/white/amber, flex bracket, Lens made in PC, ADR appr. cable 2m + 2p. Superseal connector 12V-0,5W, 24V-1W</p>	 Salida cable interior	
A31-3103-024 Izquierdo	1	<p>Piloto lateral posición LED SUPERPOINT IV, tulipa incolora, rojo/blanca/ámbar soporte goma flexible, ADR, cable 0.25m puntas abiertas 12V-0,5W, 24V-1W, IP69K</p> <p>LED End Outline Marker SUPERPOINT IV Lens red/white/amber, flex bracket, Lens made in PC, ADR appr. cable 0.25m with open end 12V-0,5W, 24V-1W</p>	 Salida cable interior	
A31-3102-024 Derecho	1	<p>Piloto lateral posición LED SUPERPOINT IV, tulipa incolora, rojo/blanca/ámbar soporte goma flexible, ADR, cable 0.25m puntas abiertas 12V-0,5W, 24V-1W, IP69K</p> <p>LED End Outline Marker SUPERPOINT IV Lens red/white/amber, flex bracket, Lens made in PC, ADR appr. cable 0.25m with open end 12V-0,5W, 24V-1W</p>	 Salida cable interior	

Pilotos Posición LED

LED End Outline Marker Lamp

Tipo: SUPERPOINT LED III ASPÖCK



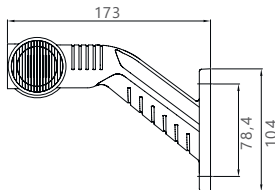





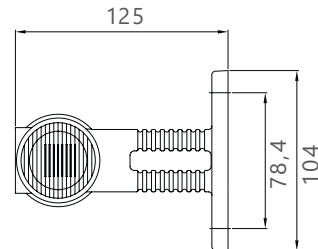

Referencia: Reference-No.	Ud. QTY	Descripción Description	Piloto Posición Lateral LED LED End Outline Marker Lamps	Tecnología LED12V/24V LED Technology 12V/24V
A31-3305-007 Izquierdo	1	Piloto lateral posición LED SUPERPOINT III , tulipa policarbonato incolora, Luz roja/blanca/ámbar soporte de goma flexible, ADR, cable 0,5m + conector ASS2 12V-0,5W, 24V-1W, IP69K		
A31-3306-007 Derecho	1	LED End Outline Marker SUPERPOINT III clear Lens, red/white/amber,flex bracket, Lens made in PC,ADR, cable 0,5m + ASS2 connector 12V-0,5W, 24V-1W, IP69K		
A31-3302-054 Izquierdo	1	Piloto lateral posición LED SUPERPOINT III , tulipa policarbonato incolora, Luz roja/blanca/ámbar soporte de goma flexible, ADR, cable 0,5m + conect. Superseal 12V-0,5W, 24V-1W, IP69K		
A31-3303-054 Derecho	1	LED End Outline Marker SUPERPOINT III clear Lens, red/white/amber,flex bracket, Lens made in PC,ADR, cable 0,5m + AMP connector 12V-0,5W, 24V-1W, IP69K		
A31-3304-047 Izquierdo	1	Piloto lateral posición LED SUPERPOINT III , tulipa policarbonato incolora, Luz roja/blanca/ámbar soporte de goma flexible, ADR, cable 1,25m + conector P&R 12V-0,5W, 24V-1W, IP69K		
A31-3304-057 Derecho	1	LED End Outline Marker SUPERPOINT III clear Lens, red/white/amber,flex bracket, Lens made in PC,ADR, cable 1,25m + P&R connector 12V-0,5W, 24V-1W, IP69K		
A31-3303-007 Izquierdo	1	Piloto lateral posición LED SUPERPOINT III , tulipa policarbonato incolora, rojo/blanca/ámbar soporte de goma flexible, Cable 4m, ADR,12V-0,5W, 24V-1W, IP69K		
A31-3302-007 Derecho	1	LED End Outline Marker SUPERPOINT III in FF-Technology Lens red/white/amber, flex short bracket, Lens made in PC, ADR cable 4m, 12V-0,5W, 24V-1W		
A21-3351-707	1	Tulipa LED SUPERPOINT III rojo/blanco/ámbar, cable 4m, 12V-0,5W, 24V-1W LED Lens SUPERPOINT III red/white/amber, cable 4m, 12V-0,5W, 24V-1W		

Pilotos Posición LED

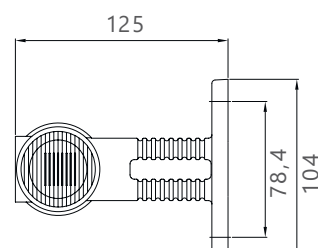
LED End Outline Marker Lamp

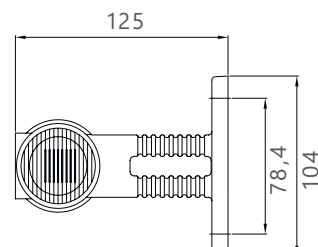
Tipo: SUPERPOINT LED III ASPÖCK

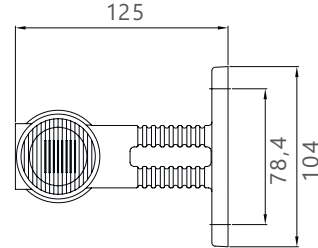











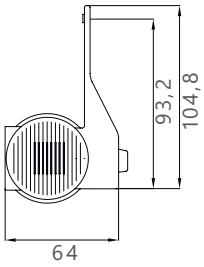

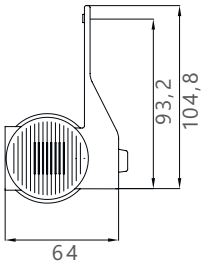
Referencia: Reference-No.	Ud. QTY	Descripción Description	Piloto Posición Lateral LED LED End Outline Marker Lamps	Tecnología LED12V/24V LED Technology 12V/24V
A31-3307-017	1	<p>Piloto lateral posición LED SUPERPOINT III, tulipa policarbonato incolora, Luz roja/blanca/ámbar soporte recto de goma flexible, cable 0,5m + conector ASS2 ADR, 12V-0,5W, 24V-1W, IP69K</p> <p>LED End Outline Marker SUPERPOINT III clear Lens, red/white/amber,flex bracket, Lens made in PC,ADR, cable 0,5m + ASS2 connector 12V-0,5W, 24V-1W, IP69K</p>	 <p>Rojo/Blanco/Ambar Conector ASS2</p>	
A31-3304-097	1	<p>Piloto lateral posición LED SUPERPOINT III, tulipa policarbonato incolora, Luz roja/blanca/ámbar soporte recto de goma flexible, cable 0,5m + conector P&R ADR, 12V-0,5W, 24V-1W, IP69K</p> <p>LED End Outline Marker SUPERPOINT III clear Lens, red/white/amber,flex bracket, Lens made in PC,ADR, cable 0,5m + P&R connector 12V-0,5W, 24V-1W, IP69K</p>	 <p>Rojo/Blanco/Ambar Conector P&R</p>	
A31-3300-247	1	<p>Piloto lateral posición LED SUPERPOINT III, tulipa policarbonato incolora, Luz roja/blanca/ámbar soporte recto de goma flexible, cable 4m ADR, 12V-0,5W, 24V-1W, IP69K</p> <p>LED End Outline Marker SUPERPOINT III clear Lens, red/white/amber,flex bracket, Lens made in PC,ADR, cable 4m 12V-0,5W, 24V-1W, IP69K</p>	 <p>Rojo/Blanco/Ambar Puntas abiertas</p>	
A31-3300-227	1	<p>Piloto lateral posición LED SUPERPOINT III, tulipa policarbonato incolora, Luz roja/blanca/ámbar soporte rector de goma flexible, Cable 2m, ADR,12V-0,5W, 24V-1W, IP69K</p> <p>LED End Outline Marker SUPERPOINT III in FF-Technology Lens red/white/amber, flex short bracket, Lens made in PC, ADR cable 2m, 12V-0,5W, 24V-1W</p>	 <p>Rojo/Blanco/Ambar Puntas abiertas</p>	
A21-3351-707	1	<p>Tulipa LED SUPERPOINT III rojo/blanco/ámbar, cable 4m, 12V-0,5W, 24V-1W</p> <p>LED Lens SUPERPOINT III red/white/amber, cable 4m, 12V-0,5W, 24V-1W</p>		

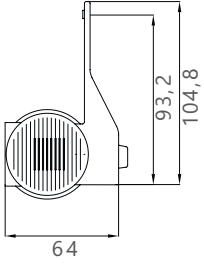
Pilotos Posición LED

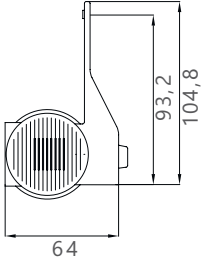
LED End Outline Marker Lamp

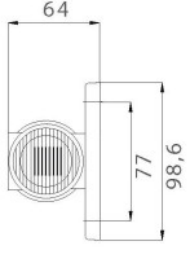
Tipo: SUPERPOINT LED III ASPÖCK

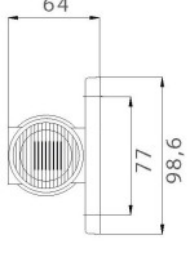





Referencia: Reference-No.	Ud. QTY	Descripción Description	Piloto Posición Lateral LED LED End Outline Marker Lamps	Tecnología LED12V/24V LED Technology 12V/24V
A31-3364-057 Izquierdo	1	Piloto lateral posición LED SUPERPOINT III , tulipa PC incolora, rojo/blanca/ámbar soporte pendular goma flexible, ADR, cable 1,5m + conector P&R 12V-0,5W, 24V-1W, IP69K	 Rojo/Blanco/Ambar Conector P&R	
A31-3364-027 Derecho	1	LED End Outline Marker SUPERPOINT III clear Lens, Red/white/amber,pendular flex bracket, Lens made in PC, ADR, cable 1,5m P&R connector 12V-0,5W, 24V-1W, IP69K	 Rojo/Blanco/Ambar Conector P&R	
A31-3365-017 Izquierdo	1	Piloto lateral posición LED SUPERPOINT III , tulipa PC incolora, rojo/blanca/ámbar soporte pendular goma flexible, ADR, cable 4m 12V-0,5W, 24V-1W, IP69K	 Rojo/Blanco/Ambar Puntas abiertas	
A31-3366-027 Derecho	1	LED End Outline Marker SUPERPOINT III clear Lens, red/white/amber,pendular flex bracket, Lens made in PC, ADR, cable 4m, 12V-0,5W, 24V-1W, IP69K	 Rojo/Blanco/Ambar Puntas abiertas	
A31-3364-007	1	Piloto lateral posición LED SUPERPOINT III , tulipa PC incolora, rojo/blanca/ámbar base de goma flexible, Cable 1.5m, P&R, ADR, 12V-0,5W, 24V-1W, IP69K LED End Outline Marker SUPERPOINT III clear Lens, red/white/amber,pendular short bracket, Lens made in PC, ADR, cable 1.5m + P&R connector 12V-0,5W, 24V-1W, IP69K	 Rojo/Blanco/Ambar Conector P&R	
A31-3360-007	1	Piloto lateral posición LED SUPERPOINT III , tulipa PC incolora, rojo/blanca/ámbar base de goma flexible, Cable 4m, ADR, 12V-0,5W, 24V-1W, IP69K LED End Outline Marker SUPERPOINT III clear Lens, red/white/amber,pendular short bracket, Lens made in PC, ADR, cable 4m, 12V-0,5W, 24V-1W, IP69K	 Rojo/Blanco/Ambar Puntas abiertas	
A21-3351-707	1	Tulipa LED SUPERPOINT III rojo/blanco/ámbar , cable 4m, 12V-0,5W, 24V-1W LED Lens SUPERPOINT III red/white/amber, cable 4m, 12V-0,5W, 24V-1W		

Pilotos Posición LED

LED End Outline Marker Lamp

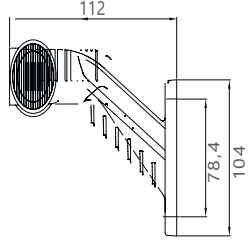
Tipo: SUPERPOINT LED III ASPÖCK

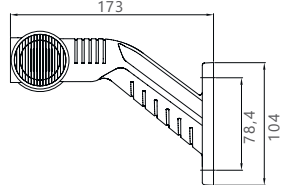

Referencia: Reference-No.	Ud. QTY	Descripción Description	Piloto Posición Lateral LED LED End Outline Marker Lamps	Tecnología LED12V/24V LED Technology 12V/24V
A31-3305-237 Izquierdo	1	<p>Piloto lateral posición LED SUPERPOINT III, para ECOLED, tulipa policarbonato incolora, Luz roja/blanca/ámbar soporte corto de goma flexible, cable 0,5m + conector ASS3 ADR, 12V-0,5W, 24V-1W, IP69K</p> <p>LED End Outline Marker SUPERPOINT III ECOLED clear Lens, red/white/amber,flex bracket, Lens made in PC,ADR, cable 0,5m + ASS3 connector 12V-0,5W, 24V-1W, IP69K</p>	 <p>Rojo/Blanco/Ambar Conector ASS3</p>	
A31-3306-237 Derecho	1	<p>Piloto lateral posición LED SUPERPOINT III, para ECOLED, tulipa policarbonato incolora, Luz roja/blanca/ámbar soporte corto de goma flexible, cable 0,5m + conector ASS3 ADR, 12V-0,5W, 24V-1W, IP69K</p> <p>LED End Outline Marker SUPERPOINT III ECOLED clear Lens, red/white/amber,flex bracket, Lens made in PC,ADR, cable 0,5m + ASS3-connector 12V-0,5W, 24V-1W, IP69K</p>	 <p>Rojo/Blanco/Ambar Conector ASS3</p>	
A31-3305-227 Izquierdo	1	<p>Piloto lateral posición LED SUPERPOINT III, tulipa policarbonato incolora, Luz roja/blanca/ámbar soporte de goma flexible, cable interior 0.5m + conector ASS2, ADR, 12V-0,5W, 24V-1W, IP69K</p> <p>LED End Outline Marker SUPERPOINT III clear Lens, red/white/amber,flex bracket, ADR, cable 0,5m + ASS2 connector 12V-0,5W, 24V-1W, IP69K</p>	<p>LECITRAILER</p>  <p>Rojo/Blanco/Ambar Salida cable por dentro</p>	
A31-3306-227 Derecho	1	<p>Piloto lateral posición LED SUPERPOINT III, tulipa policarbonato incolora, rojo/blanca/ámbar soporte goma flexible, Cable interior 0.5m, + conector ASS2 ADR, 12V-0,5W, 24V-1W, IP69K</p> <p>LED End Outline Marker SUPERPOINT III clear Lens, red/white/amber,flex bracket, ADR, cable 0,5m + ASS2 connector 12V-0,5W, 24V-1W, IP69K</p>	<p>LECITRAILER</p>  <p>Rojo/Blanco/Ambar Salida cable por dentro</p>	
A21-3351-707	1	<p>Tulipa LED SUPERPOINT III rojo/blanco/ámbar, cable 4m, 12V-0,5W, 24V-1W</p> <p>LED Lens SUPERPOINT III red/white/amber, cable 4m, 12V-0,5W, 24V-1W</p>		

Pilotos Posición LED

LED End Outline Marker Lamp

Tipo: SUPERPOINT LED



Referencia: Reference-No.	Ud. QTY	Descripción Description	Piloto Posición Lateral LED LED End Outline Marker Lamps	Tecnología LED12V/24V LED Technology 12V/24V
P40.167.004	2	Piloto lateral posición LED SUPERPOINT , tulipa PC, Luz roja/blanca / soporte de goma flexible 90°, cable 1,75m ADR, 24V-0.8W, IP69K LED End Outline Marker SUPERPOINT Lens red/white, flex bracket 90°, Lens made in PC, ADR approved, cable 1,75m, 24V/0,85W	 <p>Luz roja/blanca Light Red/White</p>	
P40.167.304	2	Piloto posición lateral LED SUPERPOINT , Cable 1,75m + P&R connector LED End Outline Marker SUPERPOINT dito., cable 1,75m + P&R con.		
P40.168.004	2	Piloto lateral posición LED SUPERPOINT , tulipa PC, Luz roja/blanca / soporte de goma recto flexible, cable 1,75m ADR, 24V-0.8W, IP69K LED End Outline Marker Lamp SUPERPOINT Lens red/white, flex short bracket, Lens made in PC, ADR approved, cable 1,75m, 24V/0,85W	 <p>Luz roja/blanca Light Red/White</p>	
P40.168.304	2	Piloto posición lateral LED SUPERPOINT , Cable 1,75m + P&R connector LED End Outline Marker SUPERPOINT dito., cable 1,75m + P&R con.		
P40.169.004	2	Piloto lateral posición LED SUPERPOINT , tulipa PC, Luz roja/blanca / soporte de goma inclinado flexible, cable 1,75m, ADR, 24V-0.8W, IP69K LED End Outline Marker Lamp SUPERPOINT Lens red/white, flex bracket 60°, Lens made in PC, ADR approved, cable 1,75m, 24V/0,85W	 <p>Luz roja/blanca Light Red/White</p>	
P40.169.304	2	Piloto posición lateral LED SUPERPOINT , Cable 1,75m + P&R connector LED End Outline Marker SUPERPOINT dito., cable 1,75m + P&R con.		
P40.167.104	2	Tulipa LED para SUPERPOINT , ADR, Cable 1,75m LED Lens for End Outline Marker Lamp SUPERPOINT , cable 1,75m,		

Pilotos Posición LED

LED End Outline Marker Lamp

Tipo: SUPERPOINT LED



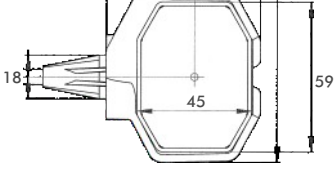



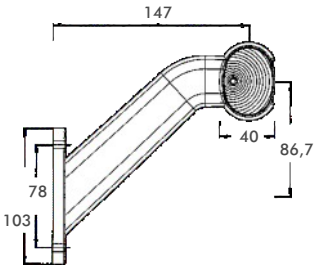

Referencia: Reference-No.	Ud. QTY	Descripción Description	Piloto Posición Lateral LED LED End Outline Marker Lamps	Tecnología LED12V/24V LED Technology 12V/24V
P40.189.004	2	Piloto lateral posición LED SUPERPOINT , tulipa PC, Luz roja/blanca / soporte con base de goma flexible, cable 1,75m, ADR, 24V-0.8W, IP69K LED End Outline Marker SUPERPOINT Lens red/white, flex housing°, Lens made in PC, ADR approved, cable 1,75m, 24V/0,85W		
P40.189.304	2	Piloto posición lateral LED SUPERPOINT , Cable 1,75m + P&R connector LED End Outline Marker SUPERPOINT dito., cable 1,75m + P&R con.	Luz roja/blanca Light Red/White	
P40.190.004	2	Piloto lateral posición LED SUPERPOINT , tulipa PC, Luz roja/blanca / soporte pendular de goma flexible, cable 1,75m, ADR, 24V-0.8W, IP69K LED End Outline Marker Lamp SUPERPOINT Lens red/white, flex bracket, Lens made in PC, ADR approved, cable 1,75m, 24V/0,85W		Distancia entre orificios 15mm o 30mm Distance fixation holes 15mm or 30mm 
P40.190.304	2	Piloto posición lateral LED SUPERPOINT , Cable 1,75m + P&R connector LED End Outline Marker SUPERPOINT dito., cable 1,75m + P&R con.	Luz roja/blanca Light Red/White	
P40.191.004	2	Piloto lateral posición LED SUPERPOINT , tulipa PC, Luz roja/blanca / soporte pendular de goma flexible 90°, cable 1,75m, ADR, 24V-0.8W, IP69K LED End Outline Marker Lamp SUPERPOINT Lens red/white, flex bracket 90°, Lens made in PC, ADR approved, cable 1,75m, 24V/0,85W		Distancia entre orificios 15mm o 30mm Distance fixation holes 15mm or 30mm 
P40.191.304	2	Piloto posición lateral LED SUPERPOINT , Cable 1,75m + P&R connector LED End Outline Marker SUPERPOINT dito., cable 1,75m + P&R con.	Luz roja/blanca Light Red/White	
P40.167.104	2	Tulipa LED para SUPERPOINT , ADR, Cable 1,75m LED Lens for End Outline Marker Lamp SUPERPOINT , cable 1,75m,		

Pilotos Posición LED

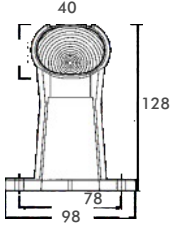
LED End Outline Marker Lamp

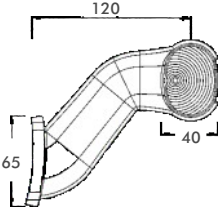
Tipo: SUPERPOINT II LED

Referencia: Reference-No.	Ud. QTY	Descripción Description	Piloto Posición Lateral LED LED End Outline Marker Lamps	Tecnología LED12V/24V LED Technology 12V/24V
P40.018.004	2	<p>Piloto lateral posición LED SUPERPOINT II, tulipa PC, Luz roja/blanca/ámbar soporte de goma angulado flexible, cable 1,75m ADR, 24V-1W, IP54</p> <p>LED End Outline Marker SUPERPOINT II Lens red/white/amber, flex bracket, Lens made in PC, ADR appr., cable 1,75m, 24V/1W</p>		
P40.018.014	2	<p>Piloto lateral posición LED SUPERPOINT II, tulipa PC, Luz roja/blanca/ámbar soporte de goma recto flexible, cable 1,75m ADR, 24V-1W, IP54</p> <p>LED End Outline Marker SUPERPOINT II Lens red/white/amber, straight flex bracket, Lens made in PC, ADR appr., cable 1,75m, 24V/1W</p>		
P40.018.024	2	<p>Piloto lateral posición LED SUPERPOINT II, para ECOPOINT tulipa PC, Luz roja/blanca/ámbar soporte de goma flexible, cable 1,75m, ADR, 24V-1W, IP54</p> <p>LED End Outline Marker SUPERPOINT II for ECOPOINT rear lamp, Lens red/white/amber, short flex bracket, Lens made in PC, ADR appr., cable 1,75m, 24V/1W</p>		
P40.018.104	2	<p>Tulipa LED para SUPERPOINT II, ADR, Cable 1,75m</p> <p>LED Lens for End Outline Marker Lamp SUPERPOINT II, ADR cable 1,75m</p>		

Pilotos Posición LED

LED End Outline Marker Lamp

Tipo: PRO-STAR



Referencia: Reference-No.	Ud. QTY	Descripción Description	Piloto Posición Lateral LED LED End Outline Marker Lamps	Tecnología LED12V/24V LED Technology 12V/24V
P40.100.004	2	<p>Piloto lateral posición LED PRO-STAR, Luz roja/blanca fijación superficie, a prueba de agua, cable 0,5m, ADR, IP54 12V-0.85W, 24V-1.8W,</p> <p>LED End Outline Marker PRO-STAR, Lens red/white, lamp complete waterproof casted, cable 0,5m, 12V-0,85W, 24V-1,8W, ADR</p>		
P40.100.504	2	<p>Piloto lateral posición LED PRO-STAR, Luz roja/blanca fijación superficie, carcasa blanca, a prueba de agua, cable 0,5m, ADR, Ip54, 12V-0.85W, 24V-1.8W,</p> <p>LED End Outline Marker PRO-STAR, Lens red/white, lamp complete waterproof casted, white housing, cable 0,5m, 12V-0,85W, 24V-1,8W, ADR</p>		
P40.100.024	2	<p>Piloto lateral posición LED PRO-STAR, Luz roja/blanca soporte goma pendular, fijación superficie, a prueba de agua, cable 0,5m, ADR, IP54 12V-0.85W, 24V-1.8W,</p> <p>LED End Outline Marker PRO-STAR, Lens red/white, lamp complete waterproof casted, flex. bracket, cable 0,5m, 12V-0,85W, 24V-1,8W, ADR</p>		

Pilotos Posición

End Outline Marker Lamp

Tipo: PRO-SUPERPOINT III









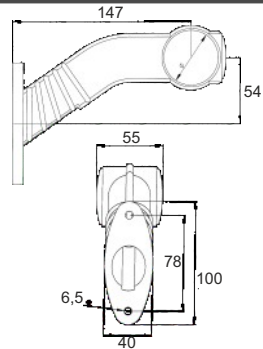

Referencia: Reference-No.	Ud. QTY	Descripción Description	Piloto Posición Lateral End Outline Marker Lamps	BA 9s / T4W
P40.107.004	2	Piloto lateral posición SUPERPOINT III , con tecnología FF , tulipa PC, Luz roja/blanca/ámbar soporte de goma angulado flexible, cable 1,75m ADR, 24V-4W, IP54, 12V/24V End Outline Marker SUPERPOINT III , in FF-Technology Lens red/white/amber, flex bracket, Lens made in PC, incl. bulb 24V/4W cable 1,75m, 12V/24V		
P40.108.004	2	Piloto lateral posición SUPERPOINT III , con tecnología FF , tulipa PC, Luz roja/blanca/ámbar base de goma flexible, cable 1,75m, ADR, 24V-4W, IP54, 12V/24V End Outline Marker SUPERPOINT III , in FF-Technology Lens red/white/amber, flex housing, Lens made in PC, incl. bulb 24V/4W cable 1,75m, 12V/24V		
P40.109.004	2	Piloto lateral posición SUPERPOINT III , con tecnología FF , tulipa PC, Luz roja/blanca/ámbar soporte de goma pendular flexible, cable 1,75m ADR, 24V-4W, IP54, 12V/24V End Outline Marker SUPERPOINT III , in FF-Technology Lens red/white/amber, flex bracket, Lens made in PC, incl. bulb 24V/4W cable 1,75m, 12V/24V		
P40.110.004	2	Piloto lateral posición SUPERPOINT III , con tecnología FF , tulipa PC, Luz roja/blanca/ámbar soporte de goma recto flexible, cable 1,75m ADR, 24V-4W, IP54, 12V/24V End Outline Marker SUPERPOINT III , in FF-Technology Lens red/white/amber, flex short bracket, Lens made in PC, incl. bulb 24V/4W cable 1,75m, 12V/24V		
P40.107.105	10	Portálmparas con bombilla incluida 24V/4W, cable 1,75m Bulb holder incl. bulb 24V/4W, cable 1,75m		
P40.107.104	10	Tulipa Policarbonato, rojo/blanco/ámbar Lens made in PC, red/white/amber		

Pilotos Posición

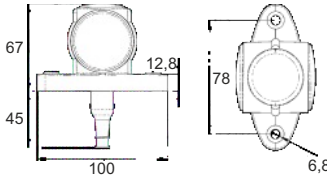
End Outline Marker Lamp

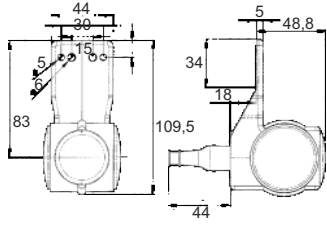
Tipo: PRO-SUPERPOINT III

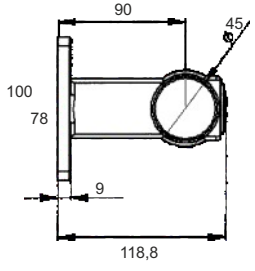

Referencia: Reference-No.	Ud. QTY	Descripción Description	Piloto Posición Lateral End Outline Marker Lamps	BA 9s / T4W
P40.107.304	2	<p>Piloto lateral posición SUPERPOINT III, con tecnología FF, tulipa PC, Luz roja/blanca/ámbar soporte de goma angulado flexible, cable 1,75m + P&R ADR, 24V-4W, IP54, 12V/24V</p> <p>End Outline Marker SUPERPOINT III, in FF-Technology Lens red/white/amber, flex bracket, Lens made in PC, incl. bulb 24V/4W cable 1,75m + P&R con.</p>		
P40.108.304	2	<p>Piloto lateral posición SUPERPOINT III, con tecnología FF, tulipa PC, Luz roja/blanca/ámbar base de goma flexible, cable 1,75m+ P&R,ADR, 24V-4W, IP54, 12V/24V</p> <p>End Outline Marker SUPERPOINT III, in FF-Technology Lens red/white/amber, flex housing, Lens made in PC, incl. bulb 24V/4W cable 1,75m + P&R con.</p>		
P40.109.304	2	<p>Piloto lateral posición SUPERPOINT III, con tecnología FF, tulipa PC, Luz roja/blanca/ámbar soporte de goma pendular flexible, cable 1,75m+ P&R ADR, 24V-4W, IP54, 12V/24V</p> <p>End Outline Marker SUPERPOINT III, in FF-Technology Lens red/white/amber, flex bracket, Lens made in PC, incl. bulb 24V/4W cable 1,75m + P&R con.</p>		
P40.110.304	2	<p>Piloto lateral posición SUPERPOINT III, con tecnología FF, tulipa PC, Luz roja/blanca/ámbar soporte de goma recto flexible, cable 1,75m + P&R ADR, 24V-4W, IP54, 12V/24V</p> <p>End Outline Marker SUPERPOINT III, in FF-Technology Lens red/white/amber, flex short bracket, Lens made in PC, incl. bulb 24V/4W cable 1,75m + P&R con.</p>		
P40.107.205	10	<p>Portalámparas con bombilla 24V/4W, cable 1,75m + P&R</p> <p>Bulb holder incl.bulb 24V/4W, cable 1,75m + P&R connector</p>		
P40.107.104	10	<p>Tulipa Policarbonato, rojo/blanco/ámbar</p> <p>Lens made in PC, red/white/amber</p>		

Pilotos Posición

End Outline Marker Lamp

Tipo: PRO-SUPERPOINT III



Referencia: Reference-No.	Ud. QTY	Descripción Description	Piloto Posición Lateral End Outline Marker Lamps	BA 9s / T4W
A31-3302-037 Izquierdo	1	Piloto lateral posición SUPERPOINT III , para ECOPOINT II , tulipa PC, Luz roja/blanca/ámbar soporte largo de goma angulado flexible, cable 1,75m ADR, 24V-4W, IP54, 12V/24V		
A31-3303-037 Derecho	1	End Outline Marker SUPERPOINT III , for ECOPOINT II , Lens red/white/amber, flex and large bracket, Lens made in PC, incl. bulb 24V/4W cable 1,75m, 12V/24V		
A31-3302-027 Derecho	1	Piloto lateral posición SUPERPOINT III , para ECOPOINT II , tulipa PC, Luz roja/blanca/ámbar soporte corto de goma angulado flexible, cable 1,75m ADR, 24V-4W, IP54, 12V/24V		
A31-3303-027 Izquierdo	1	End Outline Marker SUPERPOINT III , in FF-Technology Lens red/white/amber, flex housing, Lens made in PC, incl. bulb 24V/4W cable 1,75m, 12V/24V		
A31-3305-077 Izquierdo	1	Piloto lateral posición SUPERPOINT III , para EUROPOINT II , tulipa PC, Luz negra/blanca/ámbar soporte largo de goma angulado flexible, cable 1,75m ADR, 24V-4W, IP54, 12V/24V		
A31-3306-077 Derecho	1	End Outline Marker SUPERPOINT III , in FF-Technology Lens red/white/amber, flex bracket, Lens made in PC, incl. bulb 24V/4W cable 1,75m, 12V/24V		
A31-3305-064 Izquierdo	1	Piloto lateral posición SUPERPOINT III , para EUROPOINT II , tulipa PC, Luz rojo/blanca/ámbar soporte corto de goma angulado flexible, cable 1,75m ADR, 24V-4W, IP54, 12V/24V		
A31-3306-064 Derecho	1	End Outline Marker SUPERPOINT III , in FF-Technology Lens red/white/amber, flex short bracket, Lens made in PC, incl. bulb 24V/4W cable 1,75m, 12V/24V		
A18-8141-017	1	Tulipa Policarbonato, negro/blanco/ámbar Lens made in PC, black/white/amber		
A18-8141-007	1	Tulipa Policarbonato, rojo/blanco/ámbar Lens made in PC, red/white/amber		

Pilotos Posición

End Outline Marker Lamp

Tipo: SUPERPOINT



Referencia: Reference-No.	Ud. QTY	Descripción Description	Piloto Posición Lateral End Outline Marker Lamps	BA 9s / T4W
P40.153.004	2	Piloto lateral posición SUPERPOINT , tulipa PC, Luz roja/blanca soporte de goma angulado 90° flexible, cable 0,5m, ADR, 24V-4W, IP68, 12V/24V End Outline Marker Lamp SUPERPOINT Lens red/white, flex bracket 90°, Lens made in PC, incl. bulb 24V/4W cable 0,5m, 12V/24V		
A31-3504-017 Izquierdo	1	Piloto lateral posición SUPERPOINT , tulipa PC, Luz roja/blanca soporte de goma angulado 90° flexible, cable 1,25m + P&R, ADR, 24V-4W, IP68, 12V/24V End Outline Marker Lamp SUPERPOINT Lens red/white, flex bracket 90°, incl. bulb 24V/4W, cable 1,75m with Aspöck P&R connector		
A31-3504-007 Derecho				
P40.158.004	2	Piloto lateral posición SUPERPOINT , tulipa PC, Luz roja/blanca soporte de goma recto flexible, cable 0,5m, ADR, 24V-4W, IP68, 12V/24V End Outline Marker Lamp SUPERPOINT Lens red/white, flex short bracket, Lens made in PC, incl. bulb 24V/4W cable 0,5m, 12V/24V		
P40.159.004	2	Piloto lateral posición SUPERPOINT , tulipa PC, Luz roja/blanca soporte de goma inclinado 60° flexible, cable 0,5m, ADR, 24V-4W, IP68, 12V/24V End Outline Marker Lamp SUPERPOINT Lens red/white, flex bracket 60°, Lens made in PC, incl. bulb 24V/4W, cable 0,5m, 12V/24V		

Pilotos Posición

End Outline Marker Lamp

Tipo: SUPERPOINT



Referencia: Reference-No.	Ud. QTY	Descripción Description	Piloto Posición Lateral End Outline Marker Lamps	BA 9s / T4W
P40.188.004	2	<p>Piloto lateral posición SUPERPOINT, tulipa PC, Luz roja/blanca base de goma flexible, cable 0,5m, ADR, 24V-4W, IP68, 12V/24V</p> <p>End Outline Marker Lamp SUPERPOINT Lens red/white, flex. housing, Lens made in PC, incl. bulb 24V/4W, cable 0,5m, 12V/24V</p>		
P40.192.004	2	<p>Piloto lateral posición SUPERPOINT, tulipa PC, Luz roja/blanca soporte pendular de goma flexible, cable 0,5m, ADR, 24V-4W, IP68, 12V/24V</p> <p>End Outline Marker Lamp SUPERPOINT Lens red/white, flex. bracket, Lens made in PC, incl. bulb 24V/4W, cable 0,5m, 12V/24V</p>		<p>Befestigungslochabstand 15mm bzw. 30mm Distance fixation holes 15mm or 30mm</p>
A18-8135-007	10	<p>Tulipa Policarbonato, roja/blanca</p> <p>Lens made in PC, red/white</p>	<p>P40.153.104</p>	
P40.153.105	10	<p>Portalámparas con bombilla 24V/4W, cable 0,5m</p> <p>Bulb holder incl. bulb 24V/4W, cable 0,5m</p>	<p>P40.153.105</p>	<p>P40.153.205</p>
P40.153.205	10	<p>Portalámparas con bombilla 24V/4W, cable 2m</p> <p>Bulb holder incl. bulb 24V/4W, cable 2,0m</p>		

Pilotos Posición

End Outline Marker Lamp

Tipo: SUPERPOINT II



Referencia: Reference-No.	Ud. QTY	Descripción Description	Piloto Posición Lateral End Outline Marker Lamps	BA 9s / T4W
A31-3404-007 Derecho	1	Piloto lateral posición SUPERPOINT II , tulipa PC, Luz roja/blanca/ámbar soporte de goma angulado flexible, cable 1,25m + P&R, ADR, 24V-4W, IP68, 12V/24V		
A31-3404-017 Izquierdo	1	End Outline Marker SUPERPOINT II Lens red/white, integr. sidemarker lamp, flex bracket, Lens made in PC, incl. bulb 24V/4W, cable 1,25m with Aspöck P&R con.		
A31-3704-007	1	Piloto lateral posición SUPERPOINT II , tulipa PC, Luz roja/blanca/ámbar soporte de goma recto flexible, cable 0,5m + P&R, ADR, 24V-4W, IP68, 12V/24V		
A31-3704-017	1	Con cable 1,5m + P&R, With cable 1,5m + P&R		
A31-3608-007 Derecho	1	Piloto lateral posición SUPERPOINT II , para ECOPOINT tulipa PC, Luz roja/blanca/ámbar soporte de goma angulado flexible, cable 0,25m, ADR, 24V-4W, IP68, 12V/24V		
A31-3608-017 Izquierdo	1	End Outline Marker SUPERPOINT II for ECOPOINT rear lamp, integr. sidemarker lamp, Lens red/white/amber made in PC, flex bracket, incl. bulb 24V/4W, fits to left and right side		
A18-8136-007	1	Tulipa Policarbonato, roja/blanca/ámbar		
		Lens with integrated sidemarker lamp made in PC		
P40.018.104	2	Tulipa LED para SUPERPOINT II Luz roja/blanca/ámbar, con cable 1,75m		
		LED Lens for End Outline Marker Lamp SUPERPOINT II, ADR cable 1,75m	A18-8136-007	P40.018.104

Pilotos Posición

End Outline Marker Lamp

Tipo: SUPERPOINT II



Referencia: Reference-No.	Ud. QTY	Descripción Description	Piloto Posición Lateral End Outline Marker Lamps	BA 9s / T4W
A31-3407-094	1	<p>Piloto lateral posición SUPERPOINT II, tulipa PC, Luz roja/blanca/ámbar soporte de goma angulado flexible, cable 1,98m + conector Aspöck ASS1, ADR, 24V-4W, IP68, 12V/24V</p> <p>End Outline Marker SUPERPOINT II right, Lens red/white, integr. sidemarker lamp, flex bracket, Lens made in PC, incl. bulb 24V/4W, cable 1,98m with Aspöck ASS1 connector</p>	 <p>SCHMITZ</p>	
A31-3707-095 Derecho	1	<p>Piloto lateral posición SUPERPOINT II, tulipa PC, Luz roja/blanca/ámbar soporte de goma recto flexible, cable 1,98m + conector Aspöck ASS1, ADR, 24V-4W, IP68, 12V/24V</p>	 <p>SCHMITZ</p>	
A31-3707-105 Izquierdo	1	<p>End Outline Marker SUPERPOINT II Lens red/white, integr. sidemarker lamp, flex bracket, Lens made in PC, incl. bulb 24V/4W, cable 1,98m with Aspöck ASS1 connector</p>	 <p>SCHMITZ</p>	
A31-3700-007	1	<p>Piloto lateral posición SUPERPOINT II, tulipa PC, Luz roja/blanca/ámbar soporte de goma recto flexible, cable 1,5m, ADR, 24V-4W, IP68, 12V/24V</p> <p>End Outline Marker SUPERPOINT II Lens red/white, integr. sidemarker lamp, flex bracket, Lens made in PC, incl. bulb 24V/4W, cable 1,5m</p>	 <p>LECITRAILER</p>	
LÑ10100163	1	<p>Piloto posición lateral tulipa roja/blanca, soporte goma flexible rector, con cable 0.5m</p> <p>End Outline Marker Lamp, Lens red/white, flex bracket, incl. cable 0.5m</p>		







Pilotos Posición

End Outline Marker Lamp

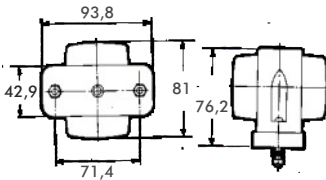
Referencia: Reference-No.	Ud. QTY	Descripción Description	Piloto Posición Lateral End Outline Marker Lamps	
P40.137.504 Izquierdo	1	Cuerno LED, Luz roja/blanca/ámbar tulipa transparente, soporte flexible, cable 0,5m conector EasyCon 24V. LED End Outline Marker, Lens red/white/amber, flex bracket, c. 0,5m with EasyCon-Conn.,24V		
P40.137.514 Derecho	1	Cuerno LED derecho LED End Outline Marker, right		
P40.137.504/1 Izquierdo	1	Cuerno LED Luz roja/blanca/ámbar soporte de goma angulado flexible, cable 0,5m puntas abiertas, 24V.		
P40.137.514/1 Derecho	1	LED End Outline Marker Lens red/white/amber, flex bracket, cable 0,5m left, 24V		
P40.116.004	2	Piloto posición lateral tulipa roja/blanca, soporte goma flexible 60°, con cable End Outline Marker Lamp, Lens red/white, flex bracket 60°, incl. cable		
P40.118.102	10	Tulipa roja Ø51mm Lens red Ø51mm		
P40.118.103	10	Tulipa blanca Ø51mm Lens white Ø51mm		
P40.118.004	2	Piloto posición lateral tulipa roja/blanca, soporte goma flexible 90°, con cable End Outline Marker Lamp, Lens red/white, flex bracket 90°, incl. cable		
P40.118.102	10	Tulipa roja Ø51mm Lens red Ø51mm		
P40.118.103	10	Tulipa blanca Ø51mm Lens white Ø51mm		
P40.116.102	10	Tulipa roja Ø54mm Lens red Ø54mm		
P40.116.103	10	Tulipa blanca Ø54mm Lens white Ø54mm		
P40.116.105	10	Portalámparas con cable Bulb holder incl. cable		
P40.116.205	10	Portalámparas Bulb holder		

Pilotos Posición

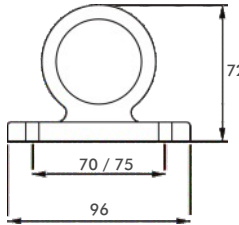
End Outline Marker Lamp

Referencia: Reference-No.	Ud. QTY	Descripción Description	Piloto Posición Lateral End Outline Marker Lamps	
P40.117.004	2	Piloto posición lateral tulipa roja/blanca, con base de goma, precableado, 2 pernos M5x18mm, IP54 End Outline Marker Lamp, Lens red/white mounted in a rubber housing		BA 15S / R5W 
P40.117.102	10	Tulipa roja para el piloto P40.117.004 Lens red for end outline marker lamp 40 117 004		
P40.117.103	10	Tulipa blanca para el piloto P40.117.004 Lens white for end outline marker lamp 40 117 004	P40.117.102	P40.117.103
P40.127.004	2	Piloto posición lateral tulipa roja/blanca, con base de goma, con cable End Outline Marker Lamp, Lens red/white mounted in a rubber housing incl. cable		BA 15S / R5W 
P40.118.101	10	Tulipa ámbar para el piloto P40.127.004 Lens amber for end outline marker 40 127 004		
P40.118.102	10	Tulipa roja para el piloto P40.127.004 Lens red for end outline marker 40 127 004		
P40.118.103	10	Tulipa blanca para el piloto P40.127.004 Lens white for end outline marker 40 127 004		
P40.116.205	10	Portalámparas con cable para el piloto P40.127.004 Bulb holder incl. cable	P40.118.101 P40.118.102 P40.118.103	P40.116.105

Pilotos Posición

End Outline Marker Lamp

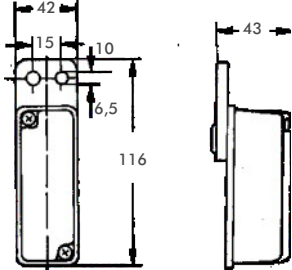
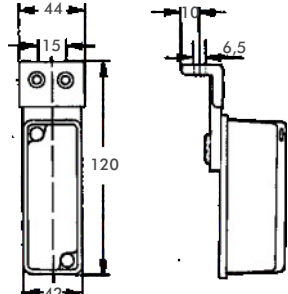
Referencia: Reference-No.	Ud. QTY	Descripción Description	Piloto Posición Lateral End Outline Marker Lamps	BA 9s / T4W
P40.101.004	10	Piloto posición lateral tulipa roja/blanca End Outline Marker Lamp Lens red/white		
P40.101.104	10	Tulipa roja/blanca Lens red/white		
P40.102.004	10	Piloto posición lateral tulipa roja/blanca, con soporte pendular flexible End Outline Marker Lamp Lens red/white, flex. bracket		
P40.103.004	10	Piloto posición lateral tulipa roja/blanca, con soporte pendular 90° flexible End Outline Marker Lamp Lens red/white, flex. 90° bracket		

Pilotos Posición

End Outline Marker Lamp

Referencia: Reference-No.	Ud. QTY	Descripción Description	Piloto Posición Lateral End Outline Marker Lamps	
P40.170.004	10	Piloto posición lateral tulipa roja/blanca End Outline Marker Lamp Lens red/white		BA 15S / R5W 
P40.170.104	10	Tulipa roja/blanca Lens red/white		
P40.171.004	10	Piloto posición lateral tulipa roja/blanca, con soporte pendular flexible End Outline Marker Lamp Lens red/white, flex. bracket		BA 15s / R5W 
P40.170.104	10	Tulipa roja/blanca Lens red/white		
P40.104.004	10	Piloto posición lateral tulipa roja/blanca, con soporte pendular flexible End Outline Marker Lamp Lens red/white, flex. bracket		SV 8,5 / C5W 
P40.104.104	10	Tulipa roja/blanca Lens red/white		RENAULT: 5000409926 VALEO: FES 88A
P40.148.004	10	Piloto posición lateral tulipa roja/blanca End Outline Marker Lamp Lens red/white		BA 9z / T4W 

Pilotos Posición

End Outline Marker Lamp

Tipo: FLEXIPOINT

Referencia: Reference-No.	Ud. QTY	Descripción Description	Piloto Posición Lateral End Outline Marker Lamps	SV 8,5 / C5W
A31-6509-047	1	<p>Piloto posición lateral FLEXIPOINT, tulipa roja/blanca, cable 0,5m con sistema Aspöck DC, 12V, 65x44x23</p> <p>End Outline Marker Lamp, FLEXIPOINT, Lens red/white, cable 0,5m with Aspöck DC-Connector System, 65x44x23</p>		
A18-8165-037	1	<p>Tulipa roja/blanca FLEXIPOINT</p> <p>Lens for End Outline Marker FLEXIPOINT</p>		
A31-6569-067	1	<p>Piloto posición lateral FLEXIPOINT, tulipa roja/blanca, con soporte pendular flexible, cable 0,5m con sistema Aspöck DC, 12V, 65x44x23</p> <p>End Outline Marker Lamp, FLEXIPOINT, Lens red/white, flex. bracket, cable 0,5m with Aspöck DC-Connector System, 65x44x23</p>		
A31-6309-027	1	<p>Piloto posición lateral LED FLEXIPOINT, tulipa roja/blanca, cable 0,5m con sistema Aspöck DC, 9-33V, 65x50x33</p> <p>LED End Outline Marker Lamp, FLEXIPOINT, Lens red/white, cable 0,5m with Aspöck DC-Connector System, 65x44x23</p>	 	
A31-6369-047 Izquierdo	1	<p>Piloto posición lateral LED FLEXIPOINT, tulipa roja/blanca, con soporte pendular flexible, cable 0,5m con sistema Aspöck DC, 12V, 65x50x33</p>	 	
A31-6369-057 Derecho		<p>LED End Outline Marker Lamp, FLEXIPOINT, Lens red/white, flex. bracket, cable 0,5m with Aspöck DC-Connector System, 65x44x23</p>		
A10-W100-537	1	<p>Herramienta para sistema Aspöck DC</p> <p>Flat-Cable on roll, 200m, for Aspöck DC-Connector System</p>		
A15-5976-017	1	<p>Sistema de conexión DC 12V incluye 2 grapas</p> <p>DC-Connector System 12V</p>		





Pilotos Posición LED

Led Position Lamp

Tipo: PRO-JACK

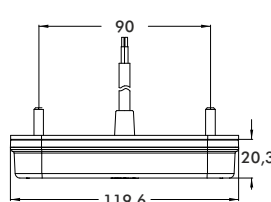
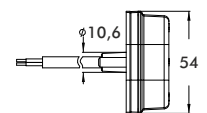

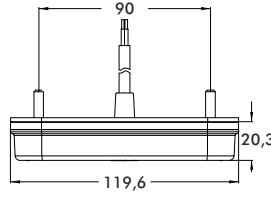
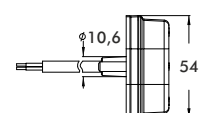
Referencia: Reference-No.	Ud. QTY	Descripción Description	Pilotos Posición LED LED Position Lamps	Esquema Drawing
P40.075.002	2	<p>Piloto Posición rojo LED PRO-JACK con Tecnología guía de Led con reflectante, diseño llamativo Iluminación homogénea, sin deslumbramiento</p> <p>Carcasa: ABS + PC Tulipa: PMMA Conexión: 0,5m puntas abiertas Voltaje: 12/24 Volt Protección: IP6K9K Montaje: horizontal / vertical Homolog.: ECE ADR EMV</p> <p>Consumo: 12V-2,0W / 24V-2,0W</p> <p><i>LED Position Lamp PRO-JACK red in Light guide technology with reflex reflector striking design homogeneous, glare-free illumination</i></p> <p>Housing: ABS + PC Lens: PMMA Cable: 0,5m open end Voltage: 12/24 Volt Protection: IP6K9K Fixation: horizontal / vertical Homologation: ECE approved ADR approved EMC approved</p> <p>Consumption: 12V-2,0W / 24V-2,0W</p>		 
P40.075.003	2	<p>Piloto Posición rojo LED PRO-JACK con Tecnología guía de Led con reflectante, diseño llamativo Iluminación homogénea, sin deslumbramiento</p> <p>Carcasa: ABS + PC Tulipa: PMMA Conexión: 0,5m puntas abiertas Voltaje: 12/24 Volt Protección: IP6K9K Montaje: horizontal / vertical Homolog.: ECE ADR EMV</p> <p>Consumo: 12V-2,0W / 24V-2,0W</p> <p><i>LED Position Lamp PRO-JACK white in Light guide technology with reflex reflector striking design homogeneous, glare-free illumination</i></p> <p>Housing: ABS + PC Lens: PMMA Cable: 0,5m open end Voltage: 12/24 Volt Protection: IP6K9K Fixation: horizontal / vertical Homologation: ECE approved ADR approved EMC approved</p> <p>Consumption: 12V-2,0W / 24V-2,0W</p>		 

Pilotos Posición LED

LED Position Lamp

Tipo: PRO-CAN XL



Referencia: Reference-No.	Ud. QTY	Descripción Description	Piloto Posición LED LED Position Lamps	Tecnología LED LED Technology
P40.026.092 24V	2	Piloto posición LED PRO-CAN XL con guía de LED, rojo, cable 0.5m a prueba de agua, versión homologada para fijación horizontal o vertical, ADR, IP67	 Tecnología guía de luz/ Light guide technology	24V / 0,8W - 12V / 1,5W Piloto en funcionamiento 
P40.026.292 12V	2	LED Position Lamp PRO-CAN XL Light guide technology, red, incl.cable 0,5m, potted version, for horizontal or vertical fixation		
P40.026.002 24V	2	Piloto posición LED PRO-CAN XL rojo, con cable 0.5m a prueba de agua, versión homologada para fijación horizontal o vertical, ADR, IP67	 18 LEDs	 
P40.026.202 12V	2	LED Position Lamp PRO-CAN XL red, incl.cable 0,5m, potted version, for horizontal or vertical fixation		
P40.026.093 24V	2	Piloto posición LED PRO-CAN XL con guía de LED, blanco, cable 0.5m a prueba de agua, versión homologada para fijación horizontal o vertical, ADR, IP67	 Tecnología luz de guía/ Light guide technology	24V / 0,8W - 12V / 1,5W Piloto en funcionamiento 
P40.026.293 12V	2	LED Position Lamp PRO-CAN XL Light guide technology, white, incl.cable 0,5m, potted version, for horizontal or vertical fixation		
P40.026.003 24V	2	Piloto posición LED PRO-CAN XL blanco, con cable 0.5m a prueba de agua, versión homologada para fijación horizontal o vertical, ADR, IP67	 18 LEDs	 
P40.026.203 12V	2	LED Position Lamp PRO-CAN XL white, incl.cable 0,5m, potted version, for horizontal or vertical fixation		
P20.017.102	2	Reflectante PRO-CAN rojo con adhesivo posterior Reflex reflector PRO-CAN red		
P20.017.103	2	Reflectante PRO-CAN blanco con adhesivo posterior Reflex reflector PRO-CAN white		
P40.026.314	2	SopORTE 90°, para versión PRO-CAN XL Bracket 90° for lamp serie PRO-CAN XL		

Pilotos Posición LED

LED Position Lamp

Tipo: PRO-CAN











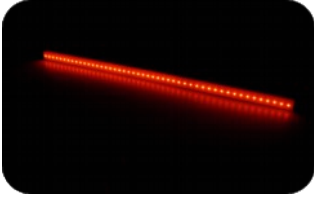

Referencia: Reference-No.	Ud. QTY	Descripción Description	Piloto Posición LED LED Position Lamps	Tecnología LED LED Technology
P40.017.022 24V	2	Piloto posición LED PRO-CAN rojo, cable 0.5m, a prueba de agua, alojamiento cromado, ADR, 24V, 0,8W, IP6K9K		24V / 0,8W - 12V / 0,4W
P40.017.222 12V	2	LED Position Lamp PRO-CAN red, chrome housing, incl. cable 0,5m, potted version		
P40.017.023 24V	2	Piloto posición LED PRO-CAN blanco, cable 0.5m, a prueba de agua, alojamiento cromado, ADR, 24V, 0,8W, IP6K9K		24V / 0,8W - 12V / 0,4W
P40.017.223 12V	2	LED Position Lamp PRO-CAN white, chrome housing, incl. cable 0,5m, potted version		
P40.017.002 24V	2	Piloto posición LED PRO-CAN rojo, cable 0.5m, a prueba de agua, ADR, 24V, 0,8W, IP6K9K		24V / 0,8W - 12V / 0,4W
P40.017.202 12V	2	LED Position Lamp PRO-CAN red, incl. cable 0,5m, potted version		
P40.017.003 24V	2	Piloto posición LED PRO-CAN blanco, cable 0.5m, a prueba de agua, ADR, 24V, 0,8W, IP6K9K		24V / 0,8W - 12V / 0,4W
P40.017.203 12V	2	LED Position Lamp PRO-CAN white, incl. cable 0,5m, potted version		
P20.017.102	2	Reflectante PRO-CAN rojo con adhesivo posterior Reflex reflector PRO-CAN red		
P20.017.103	2	Reflectante PRO-CAN blanco con adhesivo posterior Reflex reflector PRO-CAN white		
P40.017.000	2	Alojamiento cromado para PRO-CAN Chrome housing incl. flexible support for LED Position Lamp PRO-CAN		

Pilotos Posición LED

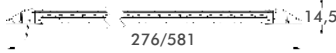
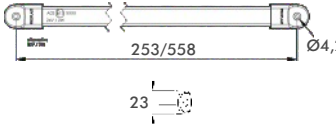
LED Position Lamp

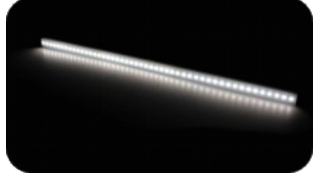
Tipo: PRO-STRIPE ECE

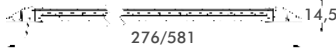
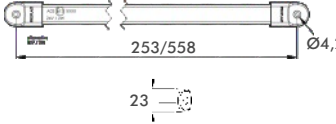

Referencia: Reference-No.	Ud. QTY	Descripción Description	Piloto Posición LED LED Position Lamps	Tecnología LED LED Technology
P40.052.002 24V	1	Piloto posición LED PRO-STRIPE ECE 1 , luz roja, montaje libre sobre la rotación del eje, cable 0.5m, a prueba de agua, versión superficie, ADR, IP6K9K, 276mm, 2W	 PRO-STRIPE ECE I 276mm	Piloto en funcionamiento 
P40.052.202 12V	1	LED Position Lamp PRO-STRIPE ECE I red, incl.cable 0,5m, potted version, IP6K9K, ADR-appr., mounting free rotated about the reference axis, 276mm, 2W		
P40.052.012 24V	1	Piloto posición LED PRO-STRIPE ECE 1 , luz roja, montaje libre sobre la rotación del eje, cable 0.5m, a prueba de agua, versión superficie, ADR, IP6K9K, 581mm, 4W	 PRO-STRIPE ECE II 581mm	 276/581
P40.052.212 12V	1	LED Position Lamp PRO-STRIPE ECE II red, incl.cable 0,5m, potted version, IP6K9K, ADR-appr., mounting free rotated about the reference axis, 581mm, 4W		 253/558 23 Ø4,2
P40.052.003 24V	1	Piloto posición LED PRO-STRIPE ECE 1 , luz blanca, montaje libre sobre la rotación del eje, cable 0.5m, a prueba de agua, versión superficie, ADR, IP6K9K, 276mm, 2W	 PRO-STRIPE ECE I 276mm	Piloto en funcionamiento 
P40.052.203 12V	1	LED Position Lamp PRO-STRIPE ECE I white, incl.cable 0,5m, potted version, IP6K9K, ADR-appr., mounting free rotated about the reference axis, 276mm, 2W		
P40.052.013 24V	1	Piloto posición LED PRO-STRIPE ECE 1 , luz blanca, montaje libre sobre la rotación del eje, cable 0.5m, a prueba de agua, versión superficie, ADR, IP6K9K, 581mm, 4W	 PRO-STRIPE ECE II 581mm	 276/581
P40.052.213 12V	1	LED Position Lamp PRO-STRIPE ECE II white, incl.cable 0,5m, potted version, IP6K9K, ADR-appr., mounting free rotated about the reference axis, 581mm, 4W		 253/558 23 Ø4,2
P40.048.200	1	Kit de montaje PRO-STRIPE ECE incluye tornillos Mounting Kit PRO-STRIPE ECE incl. screws	 P40.048. 200	

Pilotos Posición LED

Led Position Lamp

Tipo: PRO-LINE



Referencia: Reference-No.	Ud. QTY	Descripción Description	Pilotos Posición LED LED Position Lamps	Esquema Drawing
P40.074.002	2	<p>Piloto Posición LED PRO-LINE "Color Edition" Carcasa: ABS + PC Tulipa: Policarbonato Conexión: 0,5m puntas abiertas Voltaje: 12/24 Volt Protección: IP6K9K Montaje: Superficie o Empotrable Homolog.: ECE ADR EMV Consumo: 12V-0,3W / 24V-0,6W</p> <p><i>LED Position Lamp PRO-LINE „Color Edition“, red Housing: ABS + PC Lens: PC Cable: 0,5m open end Voltage: 12/24 Volt Protection: IP6K9K Fixation: recessed or pendant pendant housing included Homologation: ECE approved ADR approved EMC approved Consumption: 12V-0,3W / 24V-0,6W</i></p>		<p>88,7</p> <p>incl. Carcasa incl. housing</p> <p>71</p> <p>26,6</p> <p>21,4</p>
P40.074.003	2	<p>Piloto Posición LED PRO-LINE "Color Edition" Carcasa: ABS + PC Tulipa: Policarbonato Conexión: 0,5m puntas abiertas Voltaje: 12/24 Volt Protección: IP6K9K Montaje: Superficie o Empotrable Homolog.: ECE ADR EMV Consumo: 12V-0,3W / 24V-0,6W</p> <p><i>LED Position Lamp PRO-LINE „Color Edition“, white Housing: ABS + PC Lens: PC Cable: 0,5m open end Voltage: 12/24 Volt Protection: IP6K9K Fixation: recessed or pendant pendant housing included Homologation: ECE approved ADR approved EMC approved Consumption: 12V-0,3W / 24V-0,6W</i></p>		<p>sin Carcasa without housing</p> <p>87,6</p> <p>71</p> <p>13,5</p> <p>55,8</p> <p>16,1</p> <p>19,5</p> <p>21,4</p>

Pilotos Posición LED

LED Position Lamp

Tipo: PRO-SLIM



Referencia: Reference-No.	Ud. QTY	Descripción Description	Piloto Posición LED LED Position Lamps	Tecnología LED LED Technology	
P40.044.002 24V	2	Piloto posición LED PRO-SLIM rojo, cable 0.5m, a prueba de agua, versión superficie, ADR, 24V, 0,9W, IP6K9K		12V - 0,45W / 24V - 0,9W	
P40.044.202 12V	2	LED Position Lamp PRO-SLIM red, cable 0,5m,potted version			
P40.044.502 24V	2	Piloto posición LED PRO-SLIM rojo, cable 5m, a prueba de agua, versión superficie, ADR, 24V, 0,9W, IP6K9K			
		LED Position Lamp PRO-SLIM red, cable 5,0m,potted version			
P40.044.003 24V	2	Piloto posición LED PRO-SLIM blanco, cable 0.5m, a prueba de agua, versión superficie, ADR, 24V, 0,9W, IP6K9K		12V - 0,45W / 24V - 0,75W	
P40.044.203 12V	2	LED Position Lamp PRO-SLIM white, cable 0,5m,potted version			
P40.044.503 24V	2	Piloto posición LED PRO-SLIM blanco, cable .5m, a prueba de agua, versión superficie, ADR, 24V, 0,9W, IP6K9K			
		LED Position Lamp PRO-SLIM white, cable 5,0m,potted version			
P40.044.402 12V	2	Piloto posición LED PRO-SLIM rojo, cable plano 0.5m, a prueba de agua, versión superficie, ADR, 24V, 0,9W, IP6K9K		12V - 0,45W	
		LED Position Lamp PRO-SLIM red, flatcable 0,5m,potted version			
P40.044.403 12V	2	Piloto posición LED PRO-SLIM blanco, cable plano 0.5m, a prueba de agua, versión superficie, ADR, 24V, 0,9W, IP6K9K		12V - 0,45W	
		LED Position Lamp PRO-SLIM white, flatcable 0,5m,potted version			

**PROPLAST**

FAHRZEUGBELEUCHTUNG

www.aspock.com

Catálogo 2022/2023

Pilotos Posición LED

Led Position Lamp

Tipo: PRO-FLAT XL



Referencia: Reference-No.	Ud. QTY	Descripción Description	Pilotos Posición LED LED Position Lamps	Esquema Drawing
P40.080.002	2	<p>Piloto Posición LED PRO-FLAT XL "Color Edition" Carcasa: ABS Tulipa: Policarbonato Conexión: 0,5m puntas abiertas Voltaje: 12/24 Volt Protección: IP6K9K Montaje: Adesivo 3M fijación rápida o con tornillos</p> <p>Homolog.: ECE EMV Consumo: 12V-0,3W / 24V-0,6W</p> <p><i>LED Position Lamp PRO-FLAT XL „Color Edition“, red Housing: ABS Lens: PC Cable: 0,5m open end Voltage: 12/24 Volt Protection: IP6K9K Fixation: 3M adhesive pad for quick fixation or screw fixation</i></p> <p><i>Homologation: ECE approved EMC approved Consumption: 12V-0,3W / 24V-0,6W</i></p>		
P40.080.003	2	<p>Piloto Posición LED PRO-FLAT XL "Color Edition" Carcasa: ABS Tulipa: Policarbonato Conexión: 0,5m puntas abiertas Voltaje: 12/24 Volt Protección: IP6K9K Montaje: Adesivo 3M fijación rápida o con tornillos</p> <p>Homolog.: ECE EMV Consumo: 12V-0,3W / 24V-0,6W</p> <p><i>LED Position Lamp PRO-FLAT XL „Color Edition“, white Housing: ABS Lens: PC Cable: 0,5m open end Voltage: 12/24 Volt Protection: IP6K9K Fixation: 3M adhesive pad for quick fixation or screw fixation</i></p> <p><i>Homologation: ECE approved EMC approved Consumption: 12V-0,3W / 24V-0,6W</i></p>		

Pilotos Posición LED

LED Position Lamp

Tipo: PRO-FLAT



Referencia: Reference-No.	Ud. QTY	Descripción Description	Piloto Posición LED LED Position Lamps	Tecnología LED LED Technology
P40.061.002	2	<p>Piloto posición rojo LED PRO-FLAT Cable 0,25m, 5 leds, soporte ligero, a prueba de agua, fijación por tornillo o adhesivo 3M, Aprobado EMC, 12V/24V</p> <p>LED Position Lamp PRO-FLAT red, incl. cable 0,25m, potted version, adhesive pad for quick fixation, alternatively screw fixation, EMC approved, 12V/24V</p>		
P40.061.003	2	<p>Piloto posición blanco LED PRO-FLAT Cable 0,25m, 5 leds, soporte ligero, a prueba de agua, fijación por tornillo o adhesivo 3M, Aprobado EMC, 12V/24V</p> <p>LED Position Lamp PRO-FLAT white, incl. cable 0,25m, potted version, adhesive pad for quick fixation, alternatively screw fixation, EMC approved, 12V/24V</p>		
P40.061.022	2	<p>Piloto posición rojo LED PRO-FLAT "Color Edition" Cable 0,25m, 5 leds, soporte ligero, a prueba de agua, fijación por tornillo o adhesivo 3M, Aprobado EMC, 12V/24V</p> <p>LED Position Lamp PRO-FLAT „Color Edition“, red, cable 0,25m, potted version, adhesive pad for quick fixation, alternatively screw fixation, EMC approved, 12V/24V</p>		
P40.061.033	2	<p>Piloto posición blanco LED PRO-FLAT "Color Edition" Cable 0,25m, 5 leds, soporte ligero, a prueba de agua, fijación por tornillo o adhesivo 3M, Aprobado EMC, 12V/24V</p> <p>LED Position Lamp PRO-FLAT „Color Edition“, white, cable 0,25m, potted version, adhesive pad for quick fixation, alternatively screw fixation, EMC approved, 12V/24V</p>		

Pilotos Posición LED

LED Position Lamp

Tipo: PRO-PENNY



Referencia: Reference-No.	Ud. QTY	Descripción Description	Piloto Posición LED LED Position Lamps	Tecnología LED LED Technology
P40.002.002	2	<p>Piloto posición LED PRO-PENNY, rojo, cable 0.5m, prueba de agua versión superficie, fijación segura con almohadilla adhesiva 3M, ADR, 12V/24V, IP6K9K</p> <p>LED Position Lamp PRO-PENNY red, incl. cable 0,5m, potted version, safely fixation with 3M adhesive pad, 12V/24V</p>		<p>12V - 1,0W / 24V - 1,5W</p>
P40.002.502	2	<p>Piloto posición LED PRO-PENNY, rojo, cable 5m,</p> <p>LED Position Lamp PRO-PENNY with cable 5,0m</p>		
P40.002.003	2	<p>Piloto posición LED PRO-PENNY, blanco, cable 0.5m, a prueba de agua versión superficie, fijación segura con almohadilla adhesiva 3M, ADR, 12V/24V, IP6K9K</p> <p>LED Position Lamp PRO-PENNY white, incl. cable 0,5m, potted version, safely fixation with 3M adhesive pad, 12V/24V</p>		<p>12V - 1,0W / 24V - 1,5W</p>
P40.002.503	2	<p>Piloto posición LED PRO-PENNY, blanco, cable 5m,</p> <p>LED Position Lamp PRO-PENNY with cable 5,0m</p>		
P40.002.402	2	<p>Piloto posición LED PRO-PENNY, rojo, cable plano 0.5m, a prueba de agua versión superficie, fijación segura con almohadilla adhesiva 3M, ADR, 12V/24V, IP6K9K</p> <p>LED Position Lamp PRO-PENNY red, incl. flatcable 0,5m, potted version, safely fixation with 3M adhesive pad, 12V/24V</p>		<p>12V - 1,0W / 24V - 1,5W</p>
P40.002.403	2	<p>Piloto posición LED PRO-PENNY, blanco, cable plano 0.5m, prueba de agua versión superficie, fijación segura con almohadilla adhesiva 3M, ADR, 12V/24V, IP6K9K</p> <p>LED Position Lamp PRO-PENNY white, incl. flatcable 0,5m, potted version, safely fixation with 3M adhesive pad, 12V/24V</p>		<p>12V - 1,0W / 24V - 1,5W</p>

Pilotos Posición LED

LED Position Lamp

Tipo: PRO-BUTTON



Referencia: Reference-No.	Ud. QTY	Descripción Description	Piloto Posición LED LED Position Lamps	Tecnología LED LED Technology
P40.065.002	2	Piloto posición rojo LED PRO-BUTTON , a prueba de agua, cable 0,5m, 12/24 V, EMC, ADR, IP6K9K LED Position Lamp PRO-BUTTON red, waterproof casted, cable 0,5m 12/24 Volt, EMC & ADR appr. IP6K9K		
P40.065.012	2	Piloto posición rojo LED PRO-BUTTON , fijación adhesivo 3M para montaje rápido LED Position Lamp PRO-BUTTON 3M adhesive pad for quick fixation		
P40.065.003	2	Piloto posición rojo LED PRO-BUTTON , a prueba de agua, cable 0,5m, 12/24 V, EMC, ADR, IP6K9K LED Position Lamp PRO-BUTTON white, waterproof casted, cable 0,5m, 12/24 Volt, EMC & ADR appr. IP6K9K		
P40.065.013	2	Piloto posición rojo LED PRO-BUTTON , fijación adhesivo 3M para montaje rápido LED Position Lamp PRO-BUTTON 3M adhesive pad for quick fixation		
P40.065.202	2	Piloto posición rojo LED PRO-BUTTON , a prueba de agua, cable plano 0,5m, 12/24V, EMC, ADR, IP6K9K LED Position Lamp PRO-BUTTON red, waterproof casted, flatcable 0,5m 12/24 Volt, EMC & ADR appr. IP6K9K		
P40.065.203	2	Piloto posición blanco LED PRO-BUTTON , a prueba de agua, cable plano 0,5m, 12/24V, EMC, ADR, IP6K9K LED Position Lamp PRO-BUTTON white, waterproof casted, flatcable 0,5m, 12/24 Volt, EMC & ADR appr. IP6K9K		

Pilotos Posición LED

LED Position Lamp

Tipo: PRO-SUPER-FLAT



Referencia: Reference-No.	Ud. QTY	Descripción Description	Piloto Posición LED LED Position Lamps	Tecnología LED LED Technology
P40.063.002	2	Piloto posición rojo LED PRO-SUPER-FLAT , Homologado para montaje horizontal o vertical, prueba de agua, cable 0,5m, 12/24V, EMC, ADR, IP6K9K LED Position Lamp PRO-SUPER-FLAT red, fixation horizontal or vertical, waterproof casted, cable 0,5m 12/24 Volt, EMC&ADR appr. IP6K9K		
P40.063.012	2	Piloto posición rojo LED PRO-SUPER-FLAT , fijación adhesivo 3M para montaje rápido LED Position Lamp PRO-SUPER-FLAT 3M adh. pad for quick fixation		
P40.063.003	2	Piloto posición blanco LED PRO-SUPER-FLAT , Homologado para montaje horizontal o vertical, prueba de agua, cable 0,5m, 12/24V, EMC, ADR, IP6K9K LED Position Lamp PRO-SUPER-FLAT white, fixation horizontal or vertical, waterproof casted, cable 0,5m 12/24 Volt, EMC&ADR appr. IP6K9K		
P40.063.013	2	Piloto posición blanco LED PRO-SUPER-FLAT , fijación adhesivo 3M para montaje rápido LED Position Lamp PRO-SUPER-FLAT 3M adhesive pad for quick fixation		
P40.063.602	2	Piloto posición rojo LED PRO-SUPER-FLAT , Homologado para montaje horizontal o vertical, prueba de agua, cable 0,5m + conector P&R, 12/24V, EMC, ADR, IP6K9K LED Position Lamp PRO-SUPER-FLAT red, fixation horizontal or vertical, waterproof casted, cable 0,5m + P&R connector, 12/24 Volt, EMC & ADR appr. IP6K9K		
P40.063.603	2	Piloto posición blanco LED PRO-SUPER-FLAT , Homologado para montaje horizontal o vertical, prueba de agua, cable 0,5m + conector P&R, 12/24V, EMC, ADR, IP6K9K LED Position Lamp PRO-SUPER-FLAT white, fixation horizontal or vertical, waterproof casted, cable 0,5m + P&R connector, 12/24 Volt, EMC & ADR appr. IP6K9K		

Pilotos Posición LED

LED Position Lamp

Tipo: PRO-SUPER-FLAT



Referencia: Reference-No.	Ud. QTY	Descripción Description	Piloto Posición LED LED Position Lamps	Tecnología LED LED Technology
P40.063.202	2	<p>Piloto posición rojo LED PRO-SUPER-FLAT, Homologado para montaje horizontal o vertical, aprueba de agua, cable plano 0,5m, ,12/24V, EMC, ADR, IP6K9K</p> <p>LED Position Lamp PRO-SUPER-FLAT red, fixation horizontal or vertical, waterproof casted, flatcable 0,5m 12/24 Volt, EMC & ADR appr. IP6K9K</p>		
P40.063.203	2	<p>Piloto posición blanco LED PRO-SUPER-FLAT, Homologado para montaje horizontal o vertical, aprueba de agua, cable plano 0,5m, ,12/24V, EMC, ADR, IP6K9K</p> <p>LED Position Lamp PRO-SUPER-FLAT white, fixation horizontal or vertical, waterproof casted, flatcable 0,5m 12/24 Volt, EMC & ADR appr. IP6K9K</p>		
P40.063.072	2	<p>Piloto posición rojo LED PRO-SUPER-FLAT, Homologado para montaje horizontal o vertical, aprueba de agua, conector 2p AMP Superseal,12/24V, EMC, ADR, IP6K9K</p> <p>LED Position Lamp PRO-SUPER-FLAT red, fixation horizontal or vertical, waterproof casted, AMP SuperSeal connector, 12/24 Volt, EMC & ADR appr. IP6K9K</p>		
P40.063.073	2	<p>Piloto posición blanco LED PRO-SUPER-FLAT, Homologado para montaje horizontal o vertical, aprueba de agua, conector 2p AMP Superseal,12/24V, EMC, ADR, IP6K9K</p> <p>LED Position Lamp PRO-SUPER-FLAT white, fixation horizontal or vertical, waterproof casted, AMP SuperSeal connector, 12/24 Volt, EMC & ADR appr. IP6K9K</p>		

Pilotos Posición LED

LED Position Lamp

Tipo: PRO-REP Tecnología Hotmelt







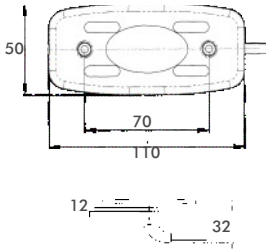

Referencia: Reference-No.	Ud. QTY	Descripción Description	Piloto Posición LED LED Position Lamps	Tecnología LED LED Technology
P40.015.502 24V	2	Piloto posición LED rojo, Cable 0,5m conexión posterior Hotmelt 90°		
P40.015.202 12V	2	LED Position Lamp red, 90°-cable connection, cable 0,5m		
P40.015.513 24V	2	Piloto posición LED blanco, Cable 0,5m conexión posterior Hotmelt 90°		
P40.015.213 12V	2	LED Position Lamp white, 90°-cable connection, cable 0,5m		
P40.015.602 24V	2	Piloto posición LED rojo, Cable 0,5m conexión posterior Hotmelt 90° y conector P&R		
		LED Position Lamp red, 90°- cable connection, cable 0,5m, w. P&R connector		
P40.015.613 24V	2	Piloto posición LED blanco, Cable 0,5m conexión posterior Hotmelt 90° y conector P&R		
		LED Position Lamp white, 90°- cable connection, cable 0,5m, w. P&R connector		
P40.015.243 12V	2	Piloto posición LED blanco, Cable plano DC 0,5m conexión posterior Hotmelt 90°		
		LED Position Lamp white, 90°-cable connection, DC-flatcable 0,5m		
P40.157.314	10	Soporte 90° para piloto posición LED.		
		90°-Bracket for LED Position Lamp	H: 43	
A15-5971-017	10	Grapa para sistema P&R de Aspöck.		
		Caps for Aspöck P&R connector, grey	P40.157.314	A15-5971-017

Pilotos Posición LED

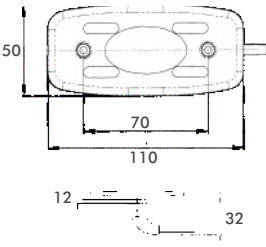
LED Position Lamp

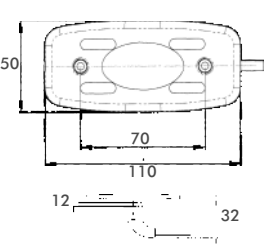

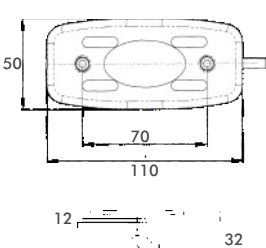
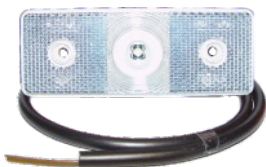
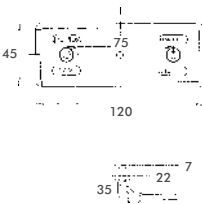
Referencia: Reference-No.	Ud. QTY	Descripción Description	Piloto Posición LED LED Position Lamps	Tecnología LED LED Technology
P40.197.513 24V	2	Piloto posición LED blanco, Cable 0,5m conexión posterior Hotmelt 90°, 24V/1W LED Position Lamp white, 90°-cable connection, cable 0,5m, 24V/1W	REFLECTANTE 	
P40.197.613 24V	2	Piloto posición LED rojo, Cable 0,5m con conector P&R, conexión posterior Hotmelt 90° LED Position Lamp white, 90°- cable connection, cable 0,5m, w. Aspöck P&R connector, 24V/1W	REFLECTANTE 	
P40.197.213 12V	2	Piloto posición LED blanco, Cable 0,5m conexión posterior Hotmelt 90°, 12V/1W LED Position Lamp white, 90°-cable connection, cable 0,5m, 12V/1W	REFLECTANTE 	
P40.197.512 24V	2	Piloto posición LED rojo, Cable 0,5m conexión posterior Hotmelt 90°, 24V/1W LED Position Lamp red with reflex reflector, 90°-cable connection, cable 0,5m, 24V/1W	REFLECTANTE 	
P40.194.003	2	Piloto posición LED blanco, Cable 0,5m conexión posterior Hotmelt 90°, 24V/1W		

Pilotos Posición LED

LED Position Lamp



Referencia: Reference-No.	Ud. QTY	Descripción Description	Piloto Posición LED LED Position Lamps	Tecnología LED LED Technology
P40.041.003/1 SCANIA 1910437	2	<p>Piloto posición blanco LED para SCANIA serie 4 y R 4 LED, sin carcasa, 24V</p> <p>LED Position Lamp SCANIA white, 4 LED's, back side connector, 24V, SCANIA 4 & R serie</p>		
P50.138.000	2	<p>Conector 2p con cable 0,3m para piloto posición Scania</p> <p>Cable for LED Position Lamp SCANIA with 2-pole connector, cable 0,3m</p>		
P40.034.502	2	<p>Piloto posición LED rojo con cable plano 0,5m, 12/24V</p> <p>LED Position Lamp red with flat cable 0,5m, 12/24V</p>		
P40.034.503	2	<p>Piloto posición LED blanco con cable plano 0,5m, 12/24V</p> <p>LED Position Lamp white with flat cable 0,5m, 12/24V</p>		
P40.020.002	2	<p>Piloto posición LED rojo, a prueba de agua, Cable 0,3m, 9-36V</p> <p>LED Position Lamp red, waterproofed housing, cable 0,3m, 9-36V</p>		
P40.020.003	2	<p>Piloto posición LED blanco, a prueba de agua, Cable 0,3m, 9-36V</p> <p>LED Position Lamp white, waterproofed housing, cable 0,3m, 9-36V</p>		

Pilotos Posición LED

LED Position Lamp



Referencia: Reference-No.	Ud. QTY	Descripción Description	Piloto Posición LED LED Position Lamps	Tecnología LED LED Technology
P40.163.502	2	Piloto posición LED rojo, Cable 0.5m conexión posterior Hotmelt 90°, 24V/0,8W LED Position Lamp red, 90°-cable connection, cable 0,5m, 24V/0,8W		
P40.164.513	2	Piloto posición LED blanco, Cable 0.5m conexión posterior Hotmelt 90°, 24V/0,8W LED Position Lamp white, 90°-cable connection, cable 0,5m, 24V/0,8W		
P40.164.523	2	Piloto posición LED con la conexión posterior recta LED Position Lamp white, straight-cable connection		
P40.163.602	2	Piloto posición LED rojo, Cable 0.5m conexión posterior Hotmelt 90° y conector P&R, 24V/0,8W LED Position Lamp red, 90°- cable connection, cable 0,5m, w. P&R connector, 24V/0,8W		
P40.164.613	2	Piloto posición LED blanco, Cable 0.5m conexión posterior Hotmelt 90° y conector P&R, 24V/0,8W LED Position Lamp white, 90°- cable connection, cable 0,5m, w. P&R connector, 24V/0,8W		
P40.164.623	2	Piloto posición LED con la conexión posterior recta LED Position Lamp white, straight-cable connection		
P40.157.314	10	Soporte piloto 90° 90°-Bracket for LED Position Lamp	 H: 43 P40.157.314	
P40.128.254	10	Cobertura de goma flexible Flex. Support	 P40.128.254	
P40.163.000	10	Soporte plástico 33mm Plastic Support 33mm	 P40.163.000	 H: 33 P40.163.000

Pilotos Posición LED

LED Position Lamp



Referencia: Reference-No.	Ud. QTY	Descripción Description	Piloto Posición LED LED Position Lamps	Tecnología LED LED Technology
P40.163.002	2	Piloto posición LED rojo, a prueba de agua, conector PG 90° con terminales 2,8mm LED Position Lamp red, waterproofed housing, 90° connector with PG-screw, 2,8mm terminals		
P40.164.013	2	Piloto posición LED blanco, a prueba de agua, conector PG 90° con terminales 2,8mm LED Position Lamp white, waterproofed housing, 90° connector with PG-screw, 2,8mm terminals		
P40.163.022	2	Piloto posición LED rojo, a prueba de agua, conector PG recto con terminales 2,8mm LED Position Lamp red, waterproofed housing, straight connector with PG-screw, 2,8mm terminals		
P40.164.023	2	Piloto posición LED blanco, a prueba de agua, conector PG recto con terminales 2,8mm LED Position Lamp white, waterproofed housing, straight connector with PG-screw, 2,8mm terminals		
P40.163.102	2	Tulipa LED roja LED Lens for LED Position Lamp		
P40.164.113	2	Tulipa LED blanca LED Lens for LED Position Lamp		
P40.157.204	2	Conector 90° con racor PG 90° Connector with PG screw		
P40.157.224	2	Conector recto con racor PG 90° Connector with PG screw		
P40.157.314	10	Soporte piloto 90° 90°-Bracket for LED Position Lamp		
P40.128.254	10	Cobertura de goma flexible Flex. Support		

Pilotos Posición LED

LED Position Lamp



Referencia: Reference-No.	Ud. QTY	Descripción Description	Piloto Posición LED LED Position Lamps	Tecnología LED LED Technology
P40.120.002	1	Piloto posición LED rojo, con reflectante, a prueba de agua, cable 0,5m, 12/24V LED Position Lamp red w. Reflex Reflector, waterproofed housing incl. cable 0,5m, 12/24V		
P40.120.003	1	Piloto posición LED blanco, con reflectante, a prueba de agua, cable 0,5m, 12/24V LED Position Lamp white w. Reflex Reflector, waterproofed housing incl. cable 0,5m, 12/24V		
P40.023.902	2	Piloto posición LED rojo, con reflectante, a prueba de agua, cable 0,5m, 12/24V, ADR LED Position Lamp red w. Reflex Reflector, waterproofed housing incl. cable 0,5m, 12/24V, ADR approved		
P40.023.903	2	Piloto posición LED blanco, con reflectante, a prueba de agua, cable 0,5m, 12/24V, ADR LED Position Lamp white w. Reflex Reflector, waterproofed housing incl. cable 0,5m, 12/24V, ADR approved		
P40.185.002	2	Piloto posición LED RUBBOPOINT I rojo, cobertura de plástico, a prueba de agua, cable 2m ADR, diámetro alojamiento 21-22.5m, 24V, 0.85W, IP6K9K LED Position Lamp MONOPOINT I red, complete plastic covered, waterproofed housing, incl. ADR cable 2,0m, fixation hole 21-22,5mm	 Luz roja Red Light	
P40.185.003	2	Piloto posición LED RUBBOPOINT I rojo, cobertura de plástico, a prueba de agua, cable 2m ADR, diámetro alojamiento 21-22.5m, 24V, 0.85W, IP6K9K LED Position Lamp MONOPOINT I white, complete plastic covered, waterproofed housing, incl. ADR cable 2,0m, fixation hole 21-22,5mm	 Luz blanca White Light	

Pilotos Posición LED

LED Position Lamp

Tipo: MONOPOINT I / II



Referencia: Reference-No.	Ud. QTY	Descripción Description	Piloto Posición LED LED Position Lamps	Tecnología LED LED Technology
A31-6800-017	1	<p>Piloto posición rojo LED MONOPOINT II, versión plana, cable 3,5m, 12/24V, IP69K, ADR</p> <p>LED Position Lamp MONOPOINT II red, flat version, cable 3,5m ,12/24V</p>		 <p>Diámetro montaje/Fixation Hole: 21mm</p>
A31-6700-027	1	<p>Piloto posición blanco LED MONOPOINT II, versión plana, cable 3,5m, 12/24V, IP69K, ADR</p> <p>LED Position Lamp MONOPOINT II white, flat version, cable 3,5m ,12/24V</p>		 <p>Diámetro montaje/Fixation Hole: 21mm</p>
A31-6804-084	1	<p>Piloto posición rojo LED MONOPOINT II, versión plana, cable 0,5m, conector P&R, 12/24V, IP69K, ADR</p> <p>LED Position Lamp MONOPOINT II red, flat version, cable 3,5m P&R,12/24V</p>		 <p>Diámetro montaje/Fixation Hole: 21mm</p>
A31-6804-064	1	<p>Versión MONOPOINT II, cable 3,5m, conector P&R,</p> <p>Version MONOPOINT II cable 3,5m P&R,</p>		
A31-6804-094	1	<p>Versión MONOPOINT II, cable 5m, conector P&R,</p> <p>Version MONOPOINT II cable 5m P&R,</p>		
A31-6704-067	1	<p>Piloto posición blanco LED MONOPOINT II, versión plana, cable 0,5m, conector P&R, 12/24V, IP69K, ADR</p> <p>LED Position Lamp MONOPOINT II red, flat version, cable 3,5m P&R,12/24V</p>		 <p>Diámetro montaje/Fixation Hole: 21mm</p>
A31-6704-074	1	<p>Versión MONOPOINT II, cable 1,5m, conector P&R,</p> <p>Version MONOPOINT II cable 1,5m P&R,</p>		
A31-6704-084	1	<p>Versión MONOPOINT II, cable 3,5m, conector P&R,</p> <p>Version MONOPOINT II cable 3,5m P&R,</p>		
A31-6704-124	1	<p>Versión MONOPOINT II, cable 5m, conector P&R,</p> <p>Version MONOPOINT II cable 5m P&R,</p>		

Pilotos Posición LED

LED Position Lamp

Tipo: MONOPOINT I / II



Referencia: Reference-No.	Ud. QTY	Descripción Description	Piloto Posición LED LED Position Lamps	Tecnología LED LED Technology
A31-6700-017	1	Piloto posición blanco LED MONOPOINT II , versión soporte alto, cable 3,5m, 12/24V, IP69K, ADR LED Position Lamp MONOPOINT II red, large version, cable 3,5m ,12/24V		
A31-6704-094	1	Piloto posición blanco LED MONOPOINT II , versión soporte alto cable 0,5m , conector P&R, 12/24V, IP69K, ADR LED Position Lamp MONOPOINT II red, large version, cable 0,5m P&R,12/24V		
A31-6704-104	1	Versión MONOPOINT II , cable 1,5m , conector P&R, Version MONOPOINT II cable 1,5m P&R,		
A31-6704-114	1	Versión MONOPOINT II , cable 3,5m , conector P&R, Version MONOPOINT II cable 3,5m P&R,		
A31-6707-054	1	Piloto posición blanco LED MONOPOINT II , versión soporte alto cable 1,5m, conector 3p ASS3 12/24V, IP69K, ADR LED Position Lamp MONOPOINT II red, flat version, cable 1,5m 3p ASS3 connector, 12/24V	 Conector 3p ASS3	 Diámetro montaje/Fixation Hole: 21mm
A31-6700-044	1	Piloto posición blanco LED MONOPOINT II , versión soporte alto cable 0,5m, conector 2p MKR 12/24V, IP69K, ADR LED Position Lamp MONOPOINT II red, flat version, cable 0,5m 2p MKR connector, 12/24V	 Conector 2p MKR	 Diámetro montaje/Fixation Hole: 21mm
A31-6700-064	1	Piloto posición blanco LED MONOPOINT II , versión soporte alto cable 0,25m, conector 2p Superseal, 12/24V, IP69K, ADR LED Position Lamp MONOPOINT II red, flat version, cable 0,25m 2p Superseal connector, 12/24V	 Conector 2p Superseal	 Diámetro montaje/Fixation Hole: 21mm

Pilotos Posición LED

LED Position Lamp



Referencia: Reference-No.	Ud. QTY	Descripción Description	Piloto Posición LED LED Position Lamps	Tecnología LED LED Technology
A31-7704-017	1	<p>Piloto posición LED UNIPOINT blanco con reflectante, cable 0,5m P&R Aspöck, 24V/1,3W IP69K</p> <p>LED Position Lamp Unipoint white w. Reflex Reflector, cable 0,5m with Aspöck P&R connector, 24V/1,3W</p>	 <p>Con Reflectante</p>	
A31-7704-037	1	<p>Piloto posición LED UNIPOINT blanco con reflectante, cable 1,5m P&R Aspöck, 24V/1,3W IP69K</p> <p>LED Position Lamp Unipoint white w. Reflex Reflector, cable 1,5m with Aspöck P&R connector, 24V/1,3W</p>	 <p>Con Reflectante</p>	
A31-7704-097	1	<p>Piloto posición LED UNIPOINT blanco sin reflectante, cable 0.5m P&R Aspöck, 24V/1,3W IP69K</p> <p>LED Position Lamp Unipoint white w/o Reflex Reflector, cable 0,5m with Aspöck P&R connector, 24V/1,3W</p>	 <p>Sin Reflectante</p>	
A31-7704-077	1	<p>Piloto posición LED UNIPOINT blanco con reflectante, cable plano 1m, 24V/1,3W IP69K</p> <p>LED Position Lamp Unipoint white w. Reflex Reflector, flat cable 1m with, 24V/1,3W</p>	 <p>Con Reflectante</p>	
A31-7704-087	1	<p>Piloto posición LED UNIPOINT blanco con reflectante, cable plano 2.5m, 24V/1,3W IP69K</p> <p>LED Position Lamp Unipoint white w. Reflex Reflector, flat cable 4m with, 24V/1,3W</p>	 <p>Con Reflectante</p>	
A31-7704-157	1	<p>Piloto posición LED UNIPOINT blanco sin reflectante, cable plano 4m, 24V/1,3W IP69K</p> <p>LED Position Lamp Unipoint white w. Reflex Reflector, flat cable 4m with, 24V/1,3W</p>	 <p>Sin Reflectante</p>	

Pilotos Posición LED

LED Position Lamp











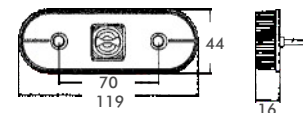

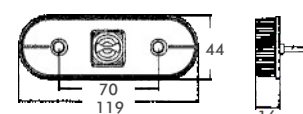

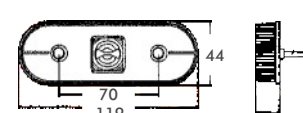

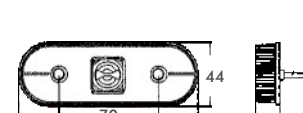
Referencia: Reference-No.	Ud. QTY	Descripción Description	Piloto Posición LED LED Position Lamps	Tecnología LED LED Technology
A31-7764-014	1	<p>Piloto posición LED UNIPOINT blanco con reflectante, soporte 90°, cable 0.50m P&R, 24V/1,3W IP69K</p> <p>LED Position Lamp Unipoint white w. Reflex Reflector, withn bracket 90°, cable 0.5m P&R, 24V/1,3W</p>	 <p>Con Reflectante</p>	
A31-7707-037	1	<p>Piloto posición LED UNIPOINT blanco con reflectante, cable 1,5m + conector 2p ASS2, 24V/1,3W, IP69K</p> <p>LED Position Lamp Unipoint white w. Reflex Reflector, cable 1,5m with Aspöck ASS2 connector, 24V/1,3W</p>	 <p>Con Reflectante</p>	
A31-7707-214	1	<p>Piloto posición LED UNIPOINT cable 0.5m</p>	 <p>Con Reflectante</p>	
A31-7707-117	1	<p>Piloto posición LED UNIPOINT blanco con reflectante, cable 1,5m + conector 2p ASS3, 24V/1,3W, IP69K</p> <p>LED Position Lamp Unipoint white w. Reflex Reflector, cable 1,5m with Aspöck ASS3 connector, 24V/1,3W</p>	 <p>Con Reflectante</p>	
A31-7700-017	1	<p>Piloto posición LED UNIPOINT blanco con reflectante, cable 0,5m puntas abiertas, 24V/1,3W, IP69K</p> <p>LED Position Lamp Unipoint white w. Reflex Reflector, cable 1,5m open end, 24V/1,3W</p>	 <p>Con Reflectante</p>	
A21-7700-004	1	<p>Tulipa posición LED UNIPOINT blanco con reflectante, 24V/1,3W, IP69K</p> <p>LED Lens Unipoint white w. Reflex Reflector, 24V/1,3W</p>	 <p>Con Reflectante</p>	
A21-7700-035	1	<p>Kit Piloto posición LED UNIPOINT blanco con reflectante, soporte 90°, 24V/1,3W, IP69K</p> <p>LED Position Lamp Unipoint white w. Reflex Reflector, flat cable 4m with, 24V/1,3W</p>	 <p>Con Reflectante</p>	

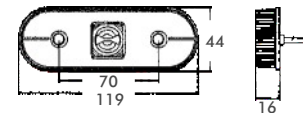
Pilotos Posición LED

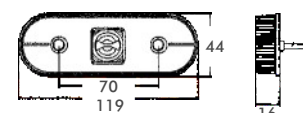
LED Position Lamp

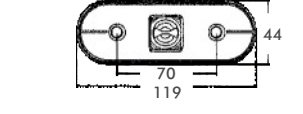









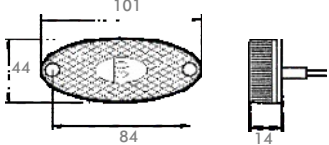

Referencia: Reference-No.	Ud. QTY	Descripción Description	Piloto Posición LED LED Position Lamps	Tecnología LED LED Technology
A31-7804-017	1	<p>Piloto posición LED UNIPPOINT rojo con reflectante, cable 0,5m P&R Aspöck, 24V/1,3W, IP69K</p> <p>LED Position Lamp Unipoint red w. Reflex Reflector, cable 0,5m with Aspöck P&R connector, 24V/1,3W</p>	 Con Reflectante	
A31-7804-077	1	<p>Piloto posición LED UNIPPOINT rojo con reflectante, cable plano 0,5m, 24V/1,3W, IP69K</p> <p>LED Position Lamp Unipoint red w. Reflex Reflector, flat cable 0,5m, 24V/1,3W</p>	 Con Reflectante	
A31-7804-097	1	<p>Piloto posición LED UNIPPOINT rojo sin reflectante, cable 0,5m P&R Aspöck, 24V/1,3W, IP69K</p> <p>LED Position Lamp Unipoint red without Reflex Reflector, cable 0,5m with Aspöck P&R connector, 24V/1,3W</p>	 Sin Reflectante	
A31-7804-127	1	<p>Piloto con cable 3,5m</p> <p>Position Lamp with cable 3,5m</p>	 Sin Reflectante	
A31-7804-087	1	<p>Piloto posición LED UNIPPOINT rojo sin reflectante, cable plano 4m, 24V/1,3W, IP69K</p> <p>LED Position Lamp Unipoint red without. Reflex Reflector, flat cable 4m , 24V/1,3W</p>	 Sin Reflectante	
A31-7800-087	1	<p>Piloto posición LED UNIPPOINT rojo sin reflectante, cable 0.5m puntas abiertas, 24V/1,3W, IP69K</p> <p>LED Position Lamp Unipoint red without. Reflex Reflector, cable 0.5m , 24V/1,3W</p>	 Sin Reflectante	
A31-7800-127	1	<p>Piloto LED UNIPPOINT, cable 3.5m</p>	 Sin Reflectante	
A31-7800-137	1	<p>Piloto posición LED UNIPPOINT rojo sin reflectante, cable 7m puntas abiertas, 24V/1,3W, IP69K</p> <p>LED Position Lamp Unipoint red without. Reflex Reflector, cable 7m , 24V/1,3W</p>	 Sin Reflectante	
A21-7800-004	1	<p>Tulipa posición LED UNIPPOINT rojo sin reflectante, 24V/1,3W, IP69K</p> <p>LED lens Position Lamp Unipoint red without. Reflex Reflector, 24V/1,3W</p>	 Sin Reflectante	

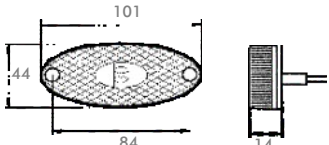
Pilotos Posición LED

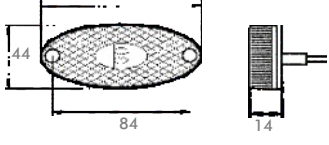
LED Position Lamp

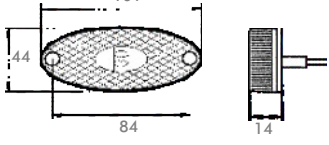
Tipo: FLATPOINT II

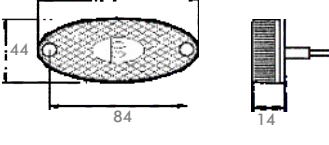
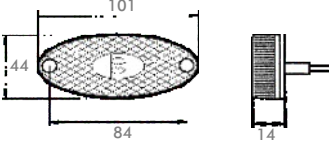

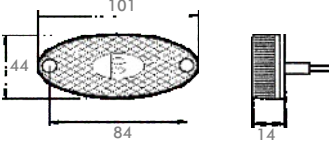
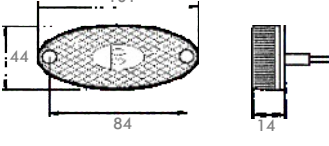







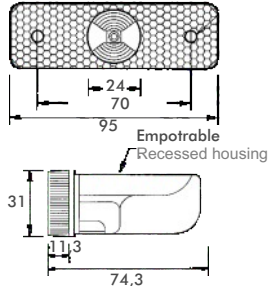

Referencia: Reference-No.	Ud. QTY	Descripción Description	Piloto Posición LED LED Position Lamps	Tecnología LED LED Technology
A31-6404-017	1	<p>Piloto posición LED FLATPOINT II rojo con reflectante, cable 0,5m con conector P&R Aspöck, 24V/1,3W, ADR, IP69K</p> <p>LED Position Lamp FLATPOINT II red w. Reflex Reflector, cable 0,5m with Aspöck P&R connector, 24V/1,3W</p>	 Con Reflectante	
A31-6404-097	1	<p>Piloto posición LED FLATPOINT II rojo sin reflectante, cable 0,5m con conector P&R Aspöck, 24V/1,3W, ADR, IP69K</p> <p>LED Position Lamp FLATPOINT II red without Reflex Reflector, cable 0,5m with Aspöck P&R connector, 24V/1,3W</p>	 Sin Reflectante	
A31-6409-007	1	<p>Piloto posición LED FLATPOINT II rojo con reflectante, cable plano 0,5m con sistema DC Aspöck, 12V/, ADR, IP69K</p> <p>LED Position Lamp FLATPOINT II red with Reflex Reflector, cable 0,5m with Aspöck D&C system, 12V</p>	<p style="text-align: center;">REFLECTANTE</p>  Con Reflectante	
A31-6900-017	1	<p>Piloto posición LED FLATPOINT II blanco con reflectante, cable 0,5m P. abiertas, 24V/1.3W, ADR, IP69K</p> <p>LED Position Lamp FLATPOINT II red w. Reflex Reflector, cable 0,5m open end, 24V/1,3W</p>	 Con Reflectante	
A31-6904-017	1	<p>Piloto posición LED FLATPOINT II blanco con reflectante, cable 0,5m con conector P&R Aspöck, 24V/1,3W, ADR, IP69K</p> <p>LED Position Lamp FLATPOINT II white w. Reflex Reflector, cable 0,5m with Aspöck P&R connector, 24V/1,3W</p>	 Con Reflectante	
A31-6904-037	1	Piloto posición con 1.5m cable P&R	Con Reflectante	
A31-6904-057	1	Piloto posición con 3.5m cable P&R		
A31-6907-027	1	<p>Piloto posición LED FLATPOINT II blanco con reflectante, cable 0,5m con conector ASS3, 24V</p> <p>LED Position Lamp FLATPOINT II white cable 0,5m ASS3 connector,</p>	 Con Reflectante	
A31-6907-037	1	Piloto posición 1.5m conector ASS3	Con Reflectante	
A31-6909-007	1	<p>Piloto posición LED FLATPOINT II blanco con reflectante, cable plano 0,5m con sistema DC Aspöck, 12V/, ADR, IP69K</p> <p>LED Position Lamp FLATPOINT II red with Reflex Reflector, cable 0,5m with Aspöck D&C system, 12V</p>		
A31-6909-057	1	Piloto posición con 2,5m cable DC	Con Reflectante	

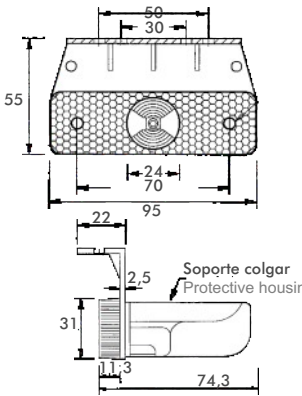
Pilotos Posición LED

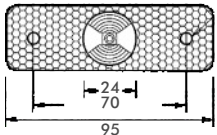
LED Position Lamp

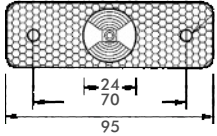
Tipo: FLATPOINT









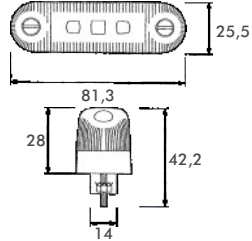

Referencia: Reference-No.	Ud. QTY	Descripción Description	Piloto Posición LED LED Position Lamps	Tecnología LED LED Technology
A21-6601-004	1	<p>Kit piloto posición LED FLATPOINT blanco, empotrable, conector 90°, 24V/1,3W, ADR, IP68</p> <p>LED Position Lamp FLATPOINT, white incl. recessed housing, bayonet joint and grommet 90°, 24V/1,3W</p>	 <p>Con Reflectante</p>	
A21-6600-004	1	<p>Kit piloto posición LED FLATPOINT blanco, soporte angular 90°, conector 90°, 24V/1,3W, ADR, IP68</p> <p>LED Position Lamp FLATPOINT, white incl. protective housing, bayonet joint and grommet 90°, 24V/1,3W, fixation bracket 90°</p>	 <p>Con Reflectante</p>	
A31-6604-007	1	<p>Piloto posición LED FLATPOINT blanco empotrable, con conector recto, cable 0.25m P&R, 24V/1,3W ADR, IP68</p> <p>LED Position Lamp FLATPOINT, white incl. rubber support, cable 0.25m with Aspöck P&R connector, 24V/1,3W</p>	 <p>Con Reflectante</p>	
A31-6604-097	1	<p>Piloto posición LED FLATPOINT blanco empotrable, con conector curvo 90°, cable 1.5m P&R, 24V/1,3W, ADR, IP68</p> <p>LED Position Lamp FLATPOINT, white incl. rubber support, bayonet joint and grommet 90°, cable 1,5m with Aspöck P&R connector, 24V/1,3W</p>	 <p>Con Reflectante</p>	
A21-6600-014 ○ A21-6600-024	1	<p>Tulipa LED blanca</p> <p>LED Lens for Position Lamp white</p>		
A15-2122-104	1	<p>Kit conector 90°</p> <p>Connector Kit for Position Lamp</p>	 <p>Con Reflectante</p>	 <p>A15-2122-104</p>

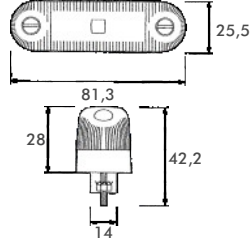
Pilotos Posición LED

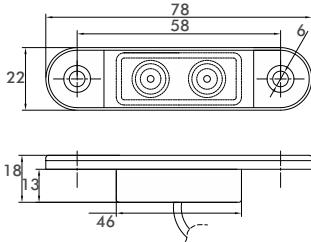
LED Position Lamp

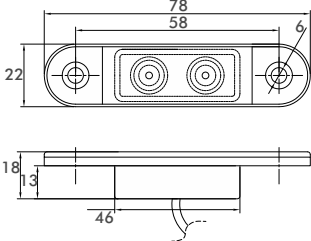









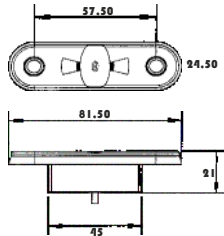

Referencia: Reference-No.	Ud. QTY	Descripción Description	Piloto Posición LED LED Position Lamps	Tecnología LED LED Technology
A31-6204-087	1	<p>Piloto posición LED POSIPPOINT rojo, con cable 0.5m P&R, 24V</p> <p>LED Position Lamp, POSIPPOINT red, incl. cable 0.5m with P&R, 24V</p>		
A31-6004-077	1	<p>Piloto posición LED POSIPPOINT blanco, con cable 0.5m P&R, 24V</p> <p>LED Position Lamp, POSIPPOINT white, incl. cable 0.5m with P&R, 24V</p>		
P31.720.400	2	<p>Piloto posición LED rojo, tulipa transparente, con reflectante, cable 0.5m conector P&R 12/ 24V ADR, IP69K</p> <p>LED Position Lamp red, incl. cable 0,5m with P&R connector, 12/24V, ADR, IP69K</p>	 <p>Luz roja Red Light</p>	
P31.710.400	2	<p>Piloto posición LED blanco, tulipa transparente, con reflectante, cable 0.5m conector P&R 12/ 24V ADR, IP69K</p> <p>LED Position Lamp white, incl. cable 0,5m with P&R connector, 12/24V, ADR IP69K</p>	 <p>Luz blanca White Light</p>	
LÑ10100088	1	<p>Piloto posición LED blanco, con reflectante, cable 0.1m conector rápido, con soporte de goma para tubo metálico, 24V</p> <p>LED Position Lamp white, cable 1,5m with housing bracket, 24V</p>	<p>LECIÑENA</p> 	
LÑ10100074	1	<p>Piloto posición LED blanco, con reflectante, cable 1.5m conector rápido, con soporte de goma para montaje sobre la barra de anclaje, 24V</p> <p>LED Position Lamp white, cable 1,5m with housing bracket, fixation in metalic bracket, 24V</p>	<p>LECIÑENA</p> 	

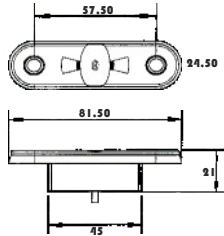
Pilotos Posición LED

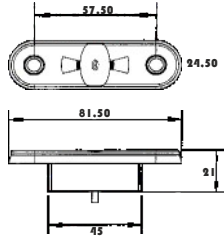
LED Position Lamp

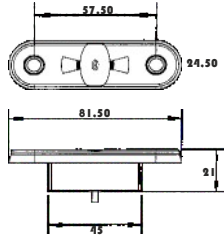
Tipo: POSIPOINT II, FLEXIPOINT

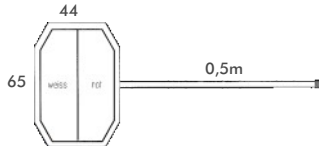

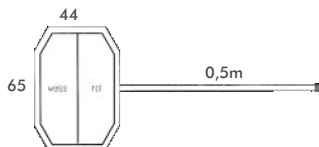
Referencia: Reference-No.	Ud. QTY	Descripción Description	Piloto Posición LED LED Position Lamps	Tecnología LED LED Technology
A31-7204-007	1	<p>Piloto posición LED POSIPOINT II, rojo, cable 0,5m P&R Aspöck, 12/24V, ADR, IP69K</p> <p>LED Position Lamp POSIPOINT, red, incl. cable 0,5m with Aspöck P&R connector, 12/24V</p>		
A31-7204-027	1	Piloto posición cable 3,5m P&R		
A31-7200-067	1	<p>Piloto posición LED POSIPOINT II, rojo, cable 0,5m puntas abiertas 12/24V, ADR, IP69K</p> <p>LED Position Lamp POSIPOINT, white incl. cable 0,5m with open end, 12/24V</p>		
A31-7200-017	1	Piloto posición cable 3,5m		
A31-7200-007	1	Piloto posición cable 5m		
A31-7104-007	1	<p>Piloto posición LED POSIPOINT II, blanco, cable 0,5m P&R Aspöck, 12/24V, ADR, IP69K</p> <p>LED Position Lamp POSIPOINT, white, incl. cable 0,5m with Aspöck P&R connector, 12/24V</p>		
A31-7104-027	1	Piloto posición cable 3,5m P&R		
A31-7100-017	1	<p>Piloto posición LED POSIPOINT II, blanco, cable 3,5m puntas abiertas 12/24V, ADR, IP69K</p> <p>LED Position Lamp POSIPOINT, white incl. cable 3,5m with open end, 12/24V</p>		
A31-6309-067	1	<p>Piloto posición LED FLEXIPOINT, rojo, cable 0,5m DC Aspöck, 12/24V, ADR, IP69K</p> <p>LED Position Lamp FLATPOINT II red w. Reflex Reflector, cable 0,5m with Aspöck DC system, 12V</p>		
A31-6309-077	1	<p>Piloto posición LED FLEXIPOINT, blanco, cable 0,5m DC Aspöck, 9/33V, ADR, IP69K</p> <p>LED Position Lamp FLATPOINT II white w. Reflex Reflector, cable 0,5m with Aspöck DC system, 12V</p>		
A31-6309-087	1	Piloto posición cable 1m DC		

Pilotos Posición LED

LED Position Lamp



Referencia: Reference-No.	Ud. QTY	Descripción Description	Piloto Posición LED LED Position Lamps	Tecnología LED LED Technology
P40.023.002/1	1	Piloto posición LED, rojo, con reflectante, a prueba de agua, cable 0,5m, 9/36V LED Position Lamp, red, w reflex reflector, waterproofed housing, cable 0,5m 9/36V		
P40.023.002/2	1	Piloto posición LED, rojo, con reflectante, a prueba de agua, cable 0,5m con conector rápidoP&R, 9/36V LED Position Lamp, red, w reflex reflector, waterproofed housing, cable 0,5m P&R, 9/36V		
P40.023.003/1	1	Piloto posición LED, blanco, con reflectante, a prueba de agua, cable 0,5m, 9/36V LED Position Lamp, white, w reflex reflector, waterproofed housing, cable 0,5m 9/36V		
P40.023.003/2	1	Piloto posición LED, blanco, con reflectante, a prueba de agua, cable 0,5m con conector rápidoP&R, 9/36V LED Position Lamp, white, w reflex reflector, waterproofed housing, cable 0,5m P&R, 9/36V		
LÑ10100113	1	Piloto posición LED blanco, con reflectante, cable 1m conector rápido 24V LED Position Lamp, white, incl. cable 1m with a fast connector, 24V	 LECIÑENA	
LÑ10100076	1	Piloto posición LED blanco, con reflectante, cable 0.3m conector rápido 24V LED Position Lamp, white, incl. cable 0.3m with a fast connector, 24V	 LECIÑENA	

Pilotos Posición LED

LED Position Lamp











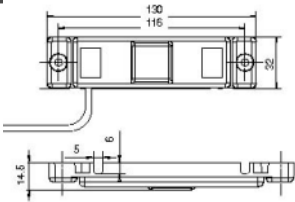

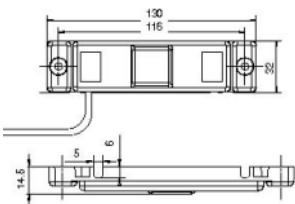
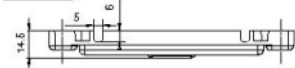

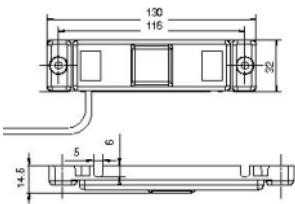

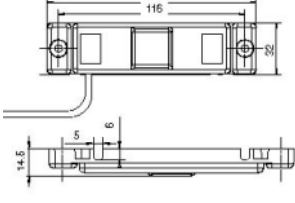
Referencia: Reference-No.	Ud. QTY	Descripción Description	Piloto Posición LED LED Position Lamps	Tecnología LED LED Technology
PA50.200.005	1	Piloto posición LED rojo, cable 0,5m, 12/24V, LED Position Lamp red, incl. cable 0,5m, 12/24V	 5 LED	
PA50.200.006	1	Piloto posición LED blanco, cable 0,5m, 12/24V, LED Position Lamp red, incl. cable 0,5m, 12/24V	 5 LED	
K50.200.006	1	Piloto posición LED rojo, cable 0,5m, 12/24V, LED Position Lamp red, incl. cable 0,5m, 12/24V	 6 LED	
K50.200.005	1	Piloto posición LED blanco, cable 0,5m, 12/24V, LED Position Lamp red, incl. cable 0,5m, 12/24V	 6 LED	
A00-0000-094	1	Kit piloto posición LED FLATPOINT II , blanco, con soporte de goma 90°, cable 1,5m P&R Aspöck, 24V, ADR, IP69K Set LED Position Lamp FLATPOINT II , white, with bracket 90°, incl. cable 1,5m with Aspöck P&R connector, 12/24V	 Soporte Goma: L000009	
LÑ10100037	1	Piloto posición LED rojo, con reflectante, cable 3,5m y conector rápido, 24V, 24V, ADR, IP69K LED Position Lamp red, with reflex reflector, cable 3,5m with a fast connector, 24V	 LECIÑENA	
LÑ10100036	1	Piloto posición LED blanco, con reflectante, cable 3,5m y conector rápido, 24V, 24V, ADR, IP69K LED Position Lamp white, with reflex reflector, cable 3,5m with a fast connector, 24V	 LECIÑENA	

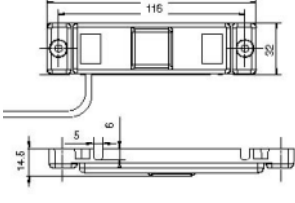
Pilotos Posición LED

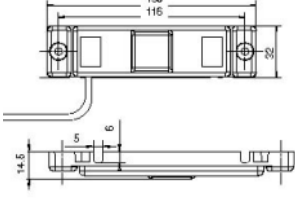
LED Position Lamp

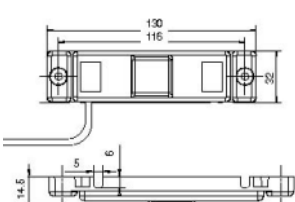

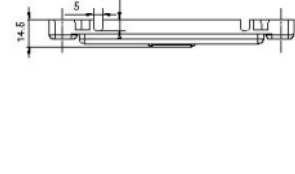
Referencia: Reference-No.	Ud. QTY	Descripción Description	Piloto Posición LED LED Position Lamps	Tecnología LED LED Technology
FA42-3474-101	1	Piloto posición LED blanco, cable 0,5m, 10/30V, CON Reflectante LED Position Lamp white, incl. cable 0,5m, 10/30V	 HORIZONTAL O VERTICAL	
FA42-3474-141	1	Piloto posición LED blanco, cable 0,5m P&R, 10/30V, CON Reflectante LED Position Lamp white, incl. cable 1,5m P&R, 10/30V	 HORIZONTAL O VERTICAL	
FA42-3474-151	1	Cable 1,5m P&R, 10/30V,	HORIZONTAL O VERTICAL	
FA42-3474-161	1	Piloto posición LED blanco, cable 5m P&R, 10/30V, CON Reflectante LED Position Lamp white, incl. cable 5m P&R, 10/30V	 HORIZONTAL O VERTICAL	
FA42-3474-171	1	Piloto posición LED blanco, cable 5m P&R, 10/30V, SIN Reflectante LED Position Lamp white, incl. cable 5m P&R, 10/30V	 HORIZONTAL O VERTICAL	
FA42-3474-201	1	Piloto posición LED Rojo, cable 0,5m, 10/30V, CON Reflectante LED Position Lamp red, incl. cable 0,5m, 10/30V	 HORIZONTAL O VERTICAL	
FA42-3474-241	1	Piloto posición LED Rojo, cable 0,5m P&R, 10/30V, CON Reflectante LED Position Lamp red, incl. cable 1,5m P&R, 10/30V	 HORIZONTAL O VERTICAL	
FA42-3474-251	1	Cable 1,5m P&R, 10/30V,	HORIZONTAL O VERTICAL	
FA42-3474-261	1	Piloto posición LED Rojo, cable 5m P&R, 10/30V, CON Reflectante LED Position Lamp red, incl. cable 5m P&R, 10/30V	 HORIZONTAL O VERTICAL	
FA42-3474-271	1	Piloto posición LED Rojo, cable 5m P&R, 10/30V, SIN Reflectante LED Position Lamp red, incl. cable 5m P&R, 10/30V	 HORIZONTAL O VERTICAL	

Pilotos Posición LED

LED Position Lamp



Referencia: Reference-No.	Ud. QTY	Descripción Description	Piloto Posición Position Lamps	BA 9s / T4W
A31-5014-027	1	Piloto posición blanca, reflectante, caja protección, cable 0.25m P&R, 24V/4W, ADR, IP68, 12/24V Position Lamp white with ref.reflector, cable 0.25m P&R, 24V, IP68, ADR		
A31-5004-027	1	Piloto posición blanca, cable 1m Position Lamp cable 1m P&R,		
A31-5004-047	1	Piloto posición blanca, reflectante, empotrable, cable 0.5m P&R, conector posterior curvo 90° 24V/4W, ADR, IP68, 12/24V Position Lamp white with ref.reflector, grommet 90°, cab. 0.5m P&R, 24V,		
A31-5004-067	1	Piloto posición blanca, cable 1,5m Position Lamp cable 1,5m P&R,	Conector curvo 	
A31-5004-187	1	Piloto posición blanca, reflectante, empotrable, cable 0.25m P&R, conector posterior recto 24V/4W, ADR, IP68, 12/24V Position Lamp white with ref.reflector, grommet 90°, cab. 0.25m P&R, 24V,		
A31-5004-097	1	Piloto posición blanca, cable 0,5m Position Lamp cable 0,5m P&R,		
A31-5004-107	1	Piloto posición blanca, cable 1,5m Position Lamp cable 1,5m P&R,	Conector recto 	
P40.123.013	8	Piloto posición blanco con reflectante, junta de goma entre tulipa y alojamiento, racor PG posterior, 12V/24V Position Lamp white with reflex reflector, rubber seal between lens and housing, 1pcs. PG-Screw, 12V/24V		
P40.123.012	8	Piloto posición rojo con reflectante, junta de goma entre tulipa y alojamiento, racor PG posterior, 12V/24V Position-/Rear Lamp red with reflex, reflector, rubber seal between lens and housing, 1pcs. PG-Screw, 12V/24V		
P40.124.013	8	Piloto posición blanco con reflectante, junta de goma entre tulipa y alojamiento, soporte colgante 90° racor PG posterior, 12V/24V Position-/Rear Lamp red with reflex, reflector, rubber seal between lens and housing, bracket 90°, 1pcs. PG-Screw, 12V/24V		
P40.123.103	10	Tulipa blanca Lens white for position lamp		
P40.123.112	10	Tulipa roja Lens red for position lamp		
P50.019.001	10	Racor PG PG-Screw		

Pilotos Posición







Position Lamp



Referencia: Reference-No.	Ud. QTY	Descripción Description	Piloto Posición Position Lamps	BA 9s / T4W
A21-5000-004	1	Piloto posición blanca, reflectante conector curvo 90°, incluye portalámparas y bombilla 24V/4W ADR, IP68, 12/24V Position Lamp white, w. reflector, bulbholder w. bayonet joint incl. bulb 24V/4W, 90° grommet, 12V/24V		
A21-5000-034	1	Piloto posición blanca, reflectante, caja protección con soporte 90°, conector curvo 90°, incluye portalámparas y bombilla 24V/4W, ADR, IP68, 12/24V Position Lamp white, w. reflector, bulbholder w. bayonet joint incl. bulb 24V/4W, 90° grommet, protective housing w. 90° bracket, 12V/24V		
A21-5000-054	1	Piloto posición blanca, reflectante y caja protección, conector curvo 90°, incluye portalámparas y bombilla 24V/4W, ADR, IP68, Position Lamp white, w. reflector, bulbholder w. bayonet joint incl. bulb 24V/4W, 90° grommet, protective housing w. 90° bracket, 12V/24V		
A21-5000-014 O A21-5000-024	1	Tulipa blanca Lens white for position lamp		
A11-2128-197	1	Cobertura de goma flexible Flex. support for position lamp		A15-2128-197
A15-2128-157	1	Caja protectora empotrable Protective housing		
A15-2128-277	1	Caja protectora con soporte 90° Protective housing with 90° bracket		
P40.128.204	10	Portalámparas con bombilla incluida Bulbholder incl. bulb for position lamp		
P40.128.214	10	Goma conector 90° Grommet 90°		

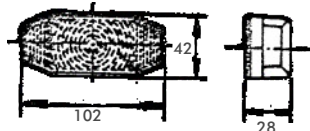

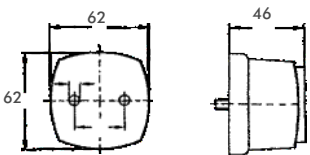

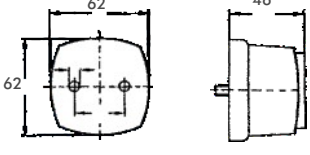





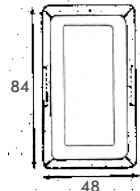
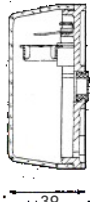

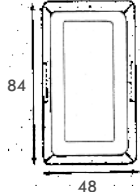
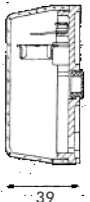
Pilotos Posición

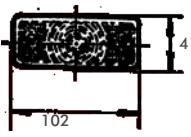
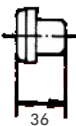
Position Lamp

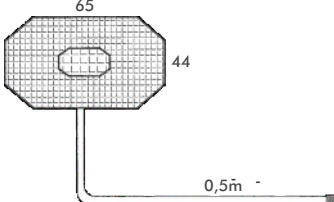
Referencia: Reference-No.	Ud. QTY	Descripción Description	Piloto Posición Position Lamps	SV 8,5 / C5W
P40.138.002	10	Piloto posición rojo, con junta de goma entre tulipa y alojamiento 12V/24V Position Lamp red, rubber seal between lens and housing, 12V/24V		
P40.138.102	10	Tulipa roja Lens red for position lamp		
P40.138.003	10	Piloto posición blanco, con junta de goma entre tulipa y alojamiento 12V/24V Position Lamp white, rubber seal between lens and housing, 12V/24V		
P40.138.103	10	Tulipa roja Lens white for position lamp		
A21-5300-007	1	Piloto posición rojo, sin reflectante 12/24V Position Lamp red with reflex reflector, 12V/24V		
A18-8153-007	1	Tulipa roja Lens red		
A21-5200-017	1	Piloto posición blanco con reflectante 12V/24V Position Lamp white with reflex reflector 12V/24V		
A18-8152-007	1	Tulipa blanca con reflectante Lens white with reflex reflector		
A21-5100-017	1	Piloto posición blanco sin reflectante 12V/24V Position Lamp white with reflex reflector 12V/24V		
A18-8151-007	1	Tulipa blanca sin reflectante Lens white with reflex reflector		
P40.184.012	10	Piloto posición rojo 12/24V Position Lamp red 12V/24V		
P40.184.013	10	Piloto posición blanco 12V/24V Position Lamp white 12V/24V		



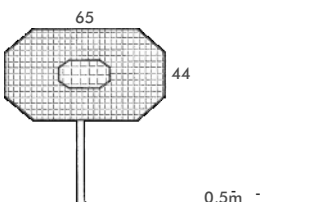



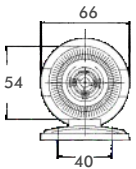
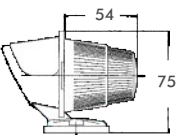

Pilotos Posición

Position Lamp

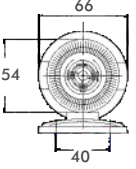
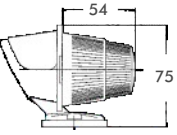
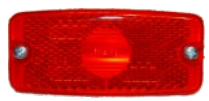
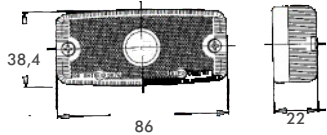
Referencia: Reference-No.	Ud. QTY	Descripción Description	Piloto Posición Position Lamps	
P40.172.002	10	Piloto posición rojo, 12V/24V Position Lamp red 12V/24V		  BA 15s / R5W
P40.172.003	10	Piloto posición blanco, 12V/24V Position Lamp white 12V/24V		  BA 15s / R5W
P40.147.003	10	Piloto posición blanco, 12V/24V Recessed Position Lamp white, rubber housing, 12V/24V		 
A31-6509-027	1	Piloto posición blanco FLEXIPOINT con reflectante, cable 0.5m sistema DC Aspöck, 12V, 65x44x23, IP54, ADR Position Lamp FLEXIPOINT , Lens white with reflex reflector, cable 0,5m with Aspöck DC-Connector System, 65x44x23		 SV 8,5 / C5W
A31-6509-107	1	Piloto posición blanco, cable 1m Position lamp cable 1m		
A31-6509-157	1	Piloto posición blanco, cable 2m Position lamp cable 2m		
A18-8165-027	1	Tulipa blanca FLEXIPOINT Lens white for Position Lamp FLEXIPOINT	 A15- 5976-017	
A31-6509-067	1	Piloto posición rojo FLEXIPOINT con reflectante, cable 0.5m sistema DC Aspöck, 12V, 65x44x23, IP54, ADR Position Lamp FLEXIPOINT , Lens red with reflex reflector, cable 0,5m with Aspöck DC-Connector System, 65x44x23		 SV 8,5 / C5W
A18-8165-007	1	Tulipa roja FLEXIPOINT Lens red for Position Lamp FLEXIPOINT		

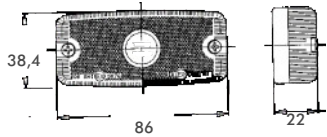

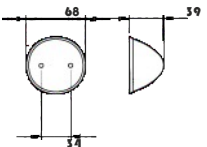

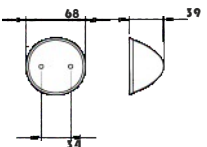



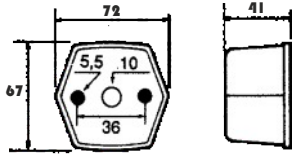

Pilotos Posición

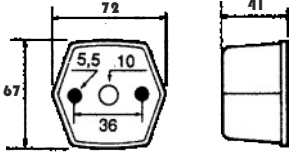
Position Lamp

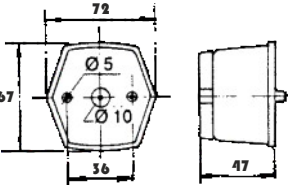
Referencia: Reference-No.	Ud. QTY	Descripción Description	Piloto Posición Position Lamps	BA 15s / R5W
P40.126.002	10	Piloto posición rojo, fijación techo, cuerpo negro, 12V/24V Position lamp red, black housing, 12V/24V		 
P40.126.012	10	Piloto posición rojo, fijación techo, cuerpo cromado, 12V/24V Position lamp amber, chrome housing, 12V/24V		
P40.126.102	10	Tulipa roja Lens red		
P40.126.003	10	Piloto posición blanco, fijación techo, cuerpo negro, 12V/24V Position lamp white, black housing, 12V/24V		 
P40.126.013	10	Piloto posición blanco, fijación techo, cuerpo cromado, 12V/24V Position lamp white, chrome housing, 12V/24V		
P40.126.103	10	Tulipa blanca Lens white		
P40.135.002	10	Piloto posición rojo con reflectante, 12V/24V Position Lamp red with reflex reflector, 12V/24V		
P40.134.003	10	Piloto posición blanco con reflectante, 12V/24V Position Lamp white with reflex reflector, 12V/24V		
P40.316.002	1	Piloto posición rojo con base de goma y cuerpo cromado, 12/24V Position lamp red, black housing, 12V/24V		 <p>SV 8.5 / C5W</p>
P40.316.003	1	Piloto posición blanco con base de goma y cuerpo cromado, 12/24V Position lamp white, black housing, 12V/24V		 <p>SV 8.5 / C5W</p>

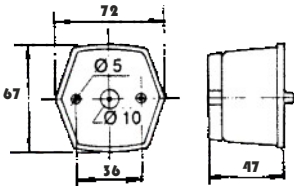
Pilotos Posición

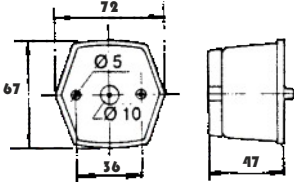
Position Lamp

Referencia: Reference-No.	Ud. QTY	Descripción Description	Piloto Posición Position Lamps	SV 8,5 / C5W
P40.139.002	10	Piloto posición rojo, 12V/24V Position Lamp red 12V/24V		
P40.139.102	10	Tulipa roja Lens red for position lamp		
P40.139.003	10	Piloto posición blanco, 12V/24V Position Lamp white 12V/24V		
P40.139.103	10	Tulipa blanca Lens white for position lamp		
P40.139.012	10	Piloto posición rojo, con reflectante, 12V/24V Position Lamp red with reflex reflector 12V/24V		
P40.139.112	10	Tulipa roja con reflectante Lens red with reflex reflector		
P40.139.013	10	Piloto posición blanco, con reflectante, 12V/24V Position Lamp white with reflex reflector 12V/24V		
P40.139.113	10	Tulipa blanca con reflectante Lens white with reflex reflector		
LÑ10100017	1	Piloto posición blanco, con reflectante, cable 0,3m sistema rápido de conexión 12V/24V Position Lamp white with reflex reflector, cable 0,3m with a fast connexion, 12V/24V		
LÑ10100010	1	Piloto posición blanco, con reflectante, cable 0,3m sistema rápido de conexión 12V/24V		
LÑ10100010/1	1	Piloto posición blanco, con conector posterior		
LÑ10100015	1	Piloto posición blanco, cable 1,5m Position Lamp, cable 1,5m		

Pilotos Balizamiento Lateral LED	LED Sidemarker Lamps	4.0	- 4.23
Pilotos Balizamiento Lateral LED con Cable	LED Sidemarker Lamps with cable		
Pilotos Balizamiento Lateral	Sidemarker Lamps	4.24	- 4.31
Pilotos Balizamiento Lateral con Cable	Sidemarker Lamps with cable		



Pilotos Balizamiento Lateral LED

LED Sidemarker Lamp

Tipo: PRO-JACK













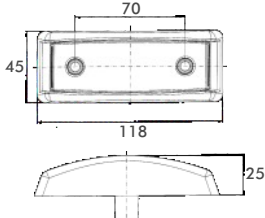

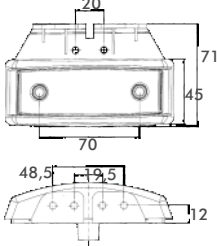
Referencia: Reference-No.	Ud. QTY	Descripción Description	Pilotos Posición LED LED Position Lamps	Esquema Drawing
P40.075.001	2	<p>Piloto Balizamiento Lateral LED PRO-JACK con Tecnología guía de Led con reflectante, diseño llamativo Iluminación homogénea, sin deslumbramiento</p> <p>Carcasa: ABS + PC Tulipa: PMMA Conexión: 0,5m puntas abiertas Voltaje: 12/24 Volt Protección: IP6K9K Montaje: horizontal / vertical Homolog.: ECE ADR EMV Consumo: 12V-2,0W / 24V-2,0W</p> <p><i>LED Sidemarker Lamp PRO-JACK in Light guide technology with reflex reflector striking design homogeneous, glare-free illumination</i></p> <p>Housing: ABS + PC Lens: PMMA Cable: 0,5m open end Voltage: 12/24 Volt Protection: IP6K9K Fixation: horizontal / vertical Homologation: ECE approved ADR approved EMC approved Consumption: 12V-2,0W / 24V-2,0W</p>		
P40.075.021	2	<p>Piloto Balizamiento Lateral LED PRO-JACK con soporte 90° y Tecnología guía de Led con reflectante, diseño llamativo Iluminación homogénea, sin deslumbramiento</p> <p>Carcasa: ABS + PC Tulipa: PMMA Conexión: 0,5m puntas abiertas Voltaje: 12/24 Volt Protección: IP6K9K Montaje: horizontal / vertical Homolog.: ECE ADR EMV Consumo: 12V-2,0W / 24V-2,0W</p> <p><i>LED Sidemarker Lamp PRO-JACK in Light guide technology with reflex reflector and 90° bracket striking design homogeneous, glare-free illumination</i></p> <p>Housing: ABS + PC Lens: PMMA Cable: 0,5m open end Voltage: 12/24 Volt Protection: IP6K9K Fixation: horizontal / vertical Homologation: ECE approved ADR approved EMC approved Consumption: 12V-2,0W / 24V-2,0W</p>		

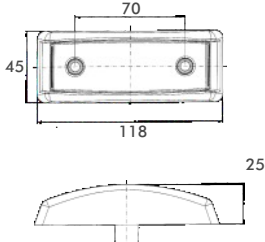
Pilotos Balizamiento Lateral LED

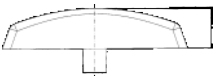
LED Sidemarker Lamp

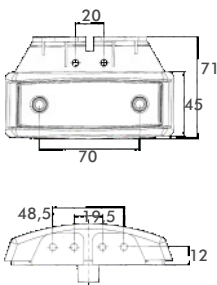
Tipo: PRO-SML

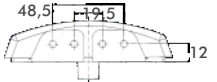

Referencia: Reference-No.	Ud. QTY	Descripción Description	Piloto Posición LED LED Sidemarker Lamps	Tecnología LED LED Technology
P40.049.001	2	<p>Piloto Balizamiento lateral LED PRO-SML, Cable 0,5m, 10-32V/1,3W, IP6K9K, ADR.</p> <p>LED Sidemarker Lamp PRO-SML, cable 0,5m, 10-32V/1,3W IP6K9K, ADR approved</p>		
P40.049.021	2	<p>Piloto Balizamiento lateral LED PRO-SML, Cable 0,5m, soporte 90°, 10-32V/1,3W, IP6K9K, ADR.</p> <p>LED Sidemarker Lamp PRO-SML, cable 0,5m, bracket 90°, 10-32V/1,3W, IP6K9K, ADR approved</p>		
P40.049.801	2	<p>Piloto Balizamiento lateral LED +función de intermitente Cat. 5, PRO-MULTI-SML, Cable 0,5m, 10-32V/1,6W, IP6K9K, ADR.</p> <p>LED Sidemarker Lamp incl. lateral LED Direction Indicator Lamp cat. 5, PRO-MULTI-SML, cable 0,5m, 10-32V/1,6W, IP6K9K, ADR approved</p>		
P40.049.501	2	<p>Piloto Balizamiento lateral LED +función de intermitente Cat. 5, PRO-MULTI-SML, conector AMP Super Seal 3p.</p> <p>LED Sidemarker Lamp incl. lateral LED Direction Indicator Lamp cat. 5, PRO-MULTI-SML, AMP SS 3-pol.</p>	  <p>Categoría 5 + LED SML</p>	
P40.049.821	2	<p>Piloto Balizamiento lateral LED +función de intermitente Cat. 5, PRO-MULTI-SML, soporte 90°, Cable 0,5m, 10-32V/1,6W, IP6K9K, ADR.</p> <p>LED Sidemarker Lamp incl. lateral LED Direction Indicator Lamp cat. 5, PRO-MULTI-SML, cable 0,5m, bracket 90°, 10-32V/1,6W, IP6K9K, ADR approved</p>		
P40.049.521	2	<p>Piloto Balizamiento lateral LED +función de intermitente Cat. 5, PRO-MULTI-SML, conector AMP Super Seal 3p.</p> <p>LED Sidemarker Lamp incl. lateral LED Direction Indicator Lamp cat. 5, PRO-MULTI-SML, AMP SS 3-pol.</p>	  <p>Categoría 5 + LED SML</p>	
P50.079.400	1	<p>Kit conector 3p, AMP SUPER SEAL</p> <p>Connector 3-poles female, AMP SUPER SEAL</p>		

Pilotos Balizamiento Lateral LED

LED Sidemarker Lamp

Tipo: PRO-BUTTON



<p>P40.065.001</p>	<p>2 Piloto Balizamiento lateral LED PRO-BUTTON, Cable 0,5m, 10-24V/1,3W, IP6K9K, ADR.</p> <p>LED Sidemarker Lamp PRO-BUTTON, waterproof casted, cable 0,5m 12/24 Volt, EMC & ADR appr. IP6K9K</p>		
<p>P40.065.011</p>	<p>2 Piloto Balizamiento lateral LED PRO-BUTTON, Cable 0,5m, Adhesivo posterior 3M, 10-24V/1,3W, IP6K9K, ADR.</p> <p>LED Sidemarker Lamp PRO-BUTTON waterproof casted, 3M adhesive pad for quick fixation, cable 0,5m, 12/24 Volt, EMC & ADR appr. IP6K9K</p>		
<p>P40.065.201</p>	<p>2 Piloto Balizamiento lateral LED PRO-BUTTON, Cable plano 0,5m, 10-24V/1,3W, IP6K9K, ADR.</p> <p>LED Sidemarker Lamp PRO-BUTTON waterproof casted, flatcable 0,5m, 12/24 Volt, EMC & ADR appr. IP6K9K</p>		
<p>P50.142.000</p>	<p>1 Contorlador intermitencia PRO-BLINK, Tipo universal, con puntas abiertas, 10-30V, ECE R48, Rev.6</p> <p>Direction Indicator Control System for Sidemarker Lamps, PRO-BLINK, type universal, Input/Output-Cable open end, 10-30V, according ECE R48, rev.6</p>		

Pilotos Balizamiento Lateral LED

LED Sidemarker Lamp

Tipo: PRO-SUPER-FLAT

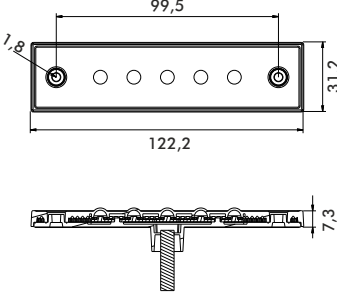

Referencia: Reference-No.	Ud. QTY	Descripción Description	Piloto Posición LED LED Sidemarker Lamps	Tecnología LED LED Technology
P40.063.001	2	<p>Piloto Balizamiento lateral LED PRO-SUPER-FLAT, homologado para montaje horizontal o vertical, estanco, cable 0,5m, 12/24V, EMC, ADR, IP6K9K</p> <p>LED Sidemarker Lamp PRO-SUPER-FLAT, fixation horizontal or vertical, waterproof casted, cable 0,5m, 12/24 Volt, EMC & ADR appr. IP6K9K</p>		
P40.063.011	2	<p>Piloto Balizamiento lateral LED PRO-SUPER-FLAT, homologado para montaje horizontal o vertical, adhesivo posterior 3M, estanco, cable plano 0,5m, 12/24V, EMC, ADR, IP6K9K</p> <p>LED Sidemarker Lamp PRO-SUPER-FLAT, fixation horizontal or vertical, waterproof casted, 3M adhesive pad for quick fixation, cable 0,5m, 12/24 Volt, EMC & ADR appr. IP6K9K</p>		
P40.063.021	2	<p>Piloto Balizamiento lateral LED PRO-SUPER-FLAT, soporte 90°, homologado para montaje horizontal o vertical, estanco, cable 0,5m, 12/24V, EMC, ADR, IP6K9K</p> <p>LED Sidemarker Lamp PRO-SUPER-FLAT, 90° bracket, fixation horizontal or vertical, waterproof casted, cable 0,5m, 12/24 Volt, EMC & ADR appr. IP6K9K</p>		
P40.063.314	2	<p>Soporte 90° para piloto lateral PRO-SUPER-FLAT</p> <p>90°-Bracket for LED Sidemarker Lamp PRO-SUPER-FLAT</p>		

Pilotos Balizamiento Lateral LED

LED Sidemarker Lamp

Tipo: PRO-SUPER-FLAT











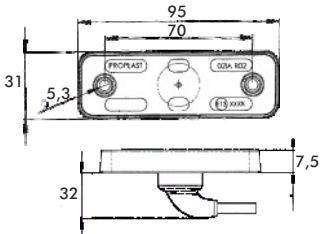

Referencia: Reference-No.	Ud. QTY	Descripción Description	Piloto Posición LED LED Sidemarker Lamps	Tecnología LED LED Technology
P40.063.601	2	<p>Piloto Balizamiento lateral LED PRO-SUPER-FLAT, homologado para montaje horizontal o vertical, estanco, cable 0,5m P&R, 12/24V, EMC, ADR, IP6K9K</p> <p>LED Sidemarker Lamp PRO-SUPER-FLAT, fixation horizontal or vertical, waterproof casted, cable 0,5m + P&R con., 12/24 Volt, EMC & ADR, IP6K9K</p>		
P40.063.201	2	<p>Piloto Balizamiento lateral LED PRO-SUPER-FLAT, homologado para montaje horizontal o vertical, estanco, cable plano 0,5m, 12/24V, EMC, ADR, IP6K9K</p> <p>LED Sidemarker Lamp PRO-SUPER-FLAT, fixation horizontal or vertical, waterproof casted, flatcable 0,5m, 12/24 Volt, EMC & ADR appr. IP6K9K</p>		
P40.063.071	2	<p>Piloto Balizamiento lateral LED PRO-SUPER-FLAT, homologado para montaje horizontal o vertical, estanco, conector AMP Superseal, 12/24V, EMC, ADR, IP6K9K</p> <p>LED Sidemarker Lamp PRO-SUPER-FLAT, fixation horizontal or vertical, waterproof casted, AMP SuperSeal con., 12/24 Volt, EMC & ADR, IP6K9K</p>		
P50.142.100	1	<p>Controlador Intermitente PRO-BLINK, Tipo Universal, puntas abiertas, 10-30V, ECE R48, Rev.6</p> <p>Direction Indicator Control System for Sidemarker Lamps, PRO-BLINK, type universal, Input-Cable open end, Output-Cable flatcable, 10-30V, according ECE R48, rev.6</p>		

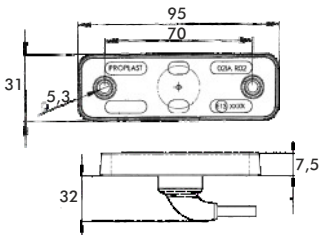
Pilotos Balizamiento Lateral LED

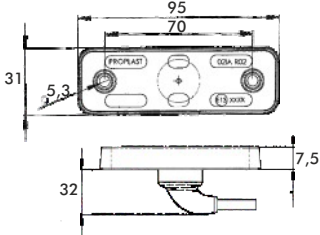
LED Sidemarker Lamp

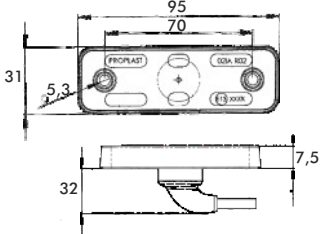
Tipo: PRO-REP
Tecnología Hotmelt

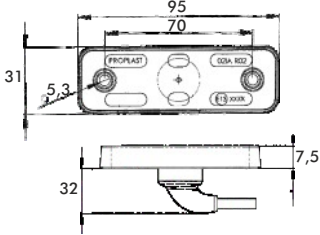









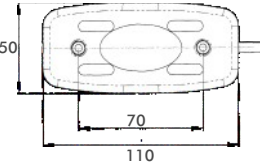

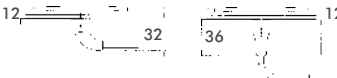

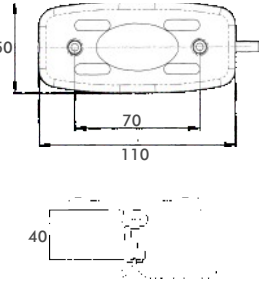
Referencia: Reference-No.	Ud. QTY	Descripción Description	Piloto Posición LED LED Sidemarker Lamps	Tecnología LED LED Technology
P40.015.501 24V	2	Piloto Balizamiento lateral LED conexión posterior Hotmelt 90° Cable 0,5m, IP54, 24V/0,8W - 12V/0,4W		
P40.015.201 12V	2	LED Sidemarker Lamp, 90°-cable connection, cable 0,5m, IP54, 24V/0,8W - 12V/0,4W		
P40.015.521 24V	2	Piloto Balizamiento lateral LED conexión posterior Hotmelt 90° Cable 0,5m, con soporte 90°, IP54, 24V/0,8W - 12V/0,4W LED Sidemarker Lamp, Bracket 90°, 90°-cable connection, cable 0,5m, IP54, 24V/0,8W		
P40.015.601 24V	2	Piloto Balizamiento lateral LED conexión posterior Hotmelt 90° Cable 0,5m con conector P&R, IP54, 24V/0,8W - 12V/0,4W		
P40.015.261 12V	2	LED Sidemarker Lamp, 90°-cable connection, cable 0,5m with P&R connector, IP54, 24V/0,8W - 12V/0,4W	Cable 0,5m	
P40.015.701 24V	2	Piloto Balizamiento lateral LED conexión posterior Hotmelt 90° Cable 1,5m con conector P&R, IP54, 24V/0,8W - 12V/0,4W LED Sidemarker Lamp, 90°-cable connection, cable 1,5m with P&R connector, IP54, 24V/0,8W - 12V/0,4W		
P40.015.241 12V	2	Piloto Balizamiento lateral LED conexión posterior Hotmelt 90° Cab. plano 0,5m, IP54, 12V/0,4W LED Sidemarker Lamp, 90°-cable connection, flatcable 0,5m, IP54, 12V/0,4W		
P40.157.314	10	Soporte colgante angulado 90° para piloto balizamiento lateral 90°-Bracket for LED Sidemarker Lamp		
A17-7225-127	1	Bobina cable ADR plano 2x, 200m para pilotos balizamiento lateral PU-Flat-Cable 40m for Aspöck P&R connector system	H: 43	
			P40.157.314	A17-7225-127

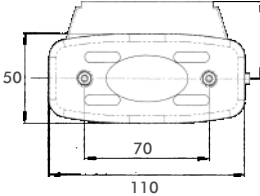
Pilotos Balizamiento Lateral LED

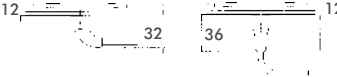
LED Sidemarker Lamp

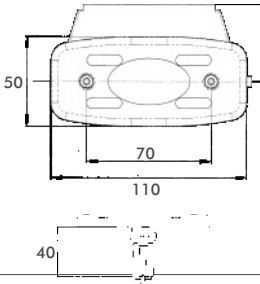







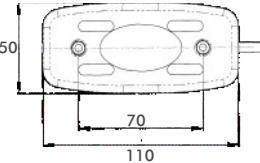

Referencia: Reference-No.	Ud. QTY	Descripción Description	Piloto Posición LED LED Sidemarker Lamps	Tecnología LED LED Technology
P40.197.501	2	Piloto balizamiento lateral LED, conexión posterior Hotmelt 90°, Cab. 0,5m, 24V/1W, ADR, IP6K9K LED Sidemarker Lamp, 90°-cable connection, cable 0,5m, 24V/1W		
P40.197.541	2	Piloto balizamiento lateral LED, conector posterior recto LED Sidemarker Lamp, straight-cable connection	 P40.197.501 P40.197.541	
P40.197.511	2	Piloto balizamiento lateral LED conexionado posterior tipo T, con 2 cables 0,2m , 24V/1W, ADR, IP6K9K LED Sidemarker Lamp, T-cable connection, cable 2 x 0,2m, 24V/1W	 P40.197.511	
P40.197.521	2	Piloto balizamiento lateral LED, conexión posterior Hotmelt 90°, soporte 90°, Cable 0,5m, 24V/1W, ADR, IP6K9K LED Sidemarker Lamp, 90°-cable connection, cable 0,5m, w. P&R connector, 24V/1W		
P40.197.551	2	Piloto balizamiento lateral LED, conexión posterior recto, soporte 90°, Cable 0,5m, 24V/1W, ADR, IP6K9K LED Sidemarker Lamp, straight-cable connection	 P40.197.521 P40.197.551	
P40.197.531	2	Piloto balizamiento lateral LED, conexión posterior 2 cables 0.2m conexión T, soporte 90°, 24V/1W, ADR, IP6K9K LED Sidemarker Lamp, 90° bracketT-cable connection, cable 2 x 0,2m, 24V/1W	 P40.197.531	
P40.157.314	10	Soporte colgante angulado 90° para piloto balizamiento lateral 90°-Bracket for LED Position Lamp	 H: 43 P40.157.314	

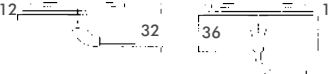
Pilotos Balizamiento Lateral LED

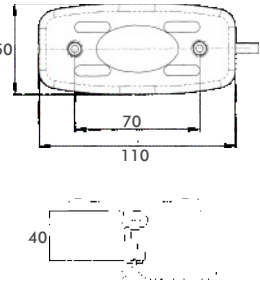
LED Sidemarker Lamp

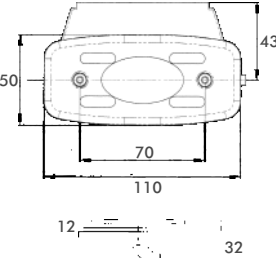

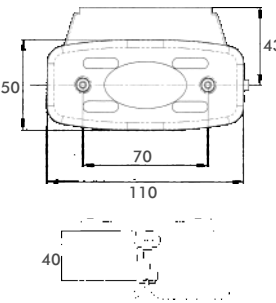





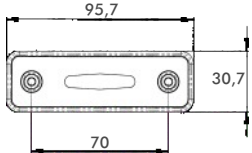

Referencia: Reference-No.	Ud. QTY	Descripción Description	Piloto Posición LED LED Sidemarker Lamps	Tecnología LED LED Technology
P40.197.201	2	<p>Piloto balizamiento lateral LED, conexión posterior Hotmelt 90°, Cable 0,5m, 12V/1W, ADR, IP6K9K</p> <p>LED Sidemarker Lamp, 90°-cable connection, cable 0,5m, 12V/1W</p>		
P40.197.241	2	<p>Piloto balizamiento lateral LED, conector posterior recto</p> <p>LED Sidemarker Lamp, straight-cable connection</p>	 <p>P40.197.201 P40.197.241</p>	
P40.197.211	2	<p>Piloto balizamiento lateral LED conexionado posterior tipo T, con 2 cables 0,2m , 12V/1W, ADR, IP6K9K</p> <p>LED Sidemarker Lamp, T-cable connection, cable 2 x 0,2m, 12V/1W</p>	 <p>P40.197.211</p>	
P40.197.221	2	<p>Piloto balizamiento lateral LED, conexión posterior Hotmelt 90°, soporte angulado 90°, Cable 0,5m, 12V/1W, ADR, IP6K9K</p> <p>LED Sidemarker Lamp, 90° bracket, 90°-cable connection, cable 0,5m, 12V/1W</p>	 <p>P40.197.221</p>	
P40.197.231	2	<p>Piloto balizamiento lateral LED conexionado posterior tipo T, con 2 cables 0,2m , soporte angulado 90°, 12V/1W, ADR, IP6K9K</p> <p>LED Sidemarker Lamp, 90° bracket, T-cable connection, cable 2 x 0,2m, 12V/1W</p>	 <p>P40.197.231</p>	

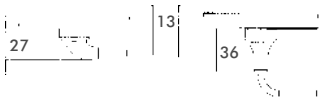
Pilotos Balizamiento Lateral LED

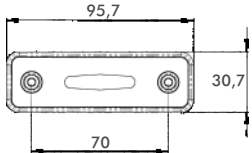
LED Sidemarker Lamp

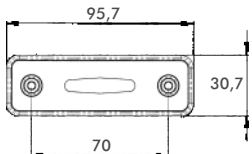





Referencia: Reference-No.	Ud. QTY	Descripción Description	Piloto Posición LED LED Sidemarker Lamps	Tecnología LED LED Technology
P40.157.501	2	<p>Piloto balizamiento lateral LED, conexión posterior Hotmelt 90°, Cable 0,5m, 24V/0.8W, ADR, IP68</p> <p>LED Sidemarker Lamp, 90°-cable connection, cable 0,5m, 24V/0,8W</p>		
P40.157.541	2	<p>Piloto balizamiento lateral LED, conector posterior recto</p> <p>LED Sidemarker Lamp, straight-cable connection</p>		
P40.157.511	2	<p>Piloto balizamiento lateral LED conexionado posterior tipo T, con 2 cables 0,2m , 24V/0.8W, ADR, IP68</p> <p>LED Sidemarker Lamp, T-cable connection, cable 2 x 0,2m, 24V/0,8W</p>		
P40.157.601	2	<p>Piloto balizamiento lateral LED, conexión posterior Hotmelt 90°, Cable 0,5m conector. P&R, 24V/0.8W, ADR, IP68</p> <p>LED Sidemarker Lamp, 90°-cable connection, cable 0,5m, w. P&R connector, 24V/0,8W</p>		
P40.128.254	10	<p>Almohadilla de goma flexible Flex. Support</p>		

Pilotos Balizamiento Lateral LED

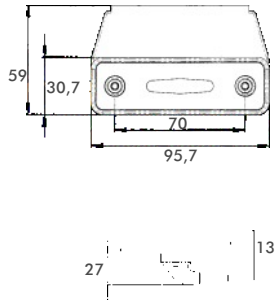
LED Sidemarker Lamp

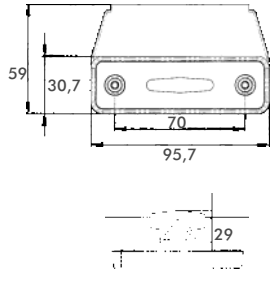

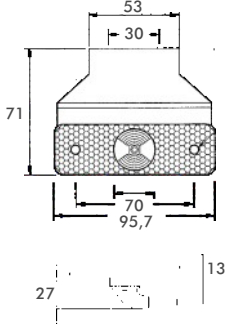
Referencia: Reference-No.	Ud. QTY	Descripción Description	Piloto Posición LED LED Sidemarker Lamps	Tecnología LED LED Technology
P40.157.521	2	<p>Piloto balizamiento lateral LED, conexión posterior Hotmelt 90°, soporte angular 90°, Cable 0,5m 24V/0.8W, ADR, IP68</p> <p>LED Sidemarker Lamp, 90° bracket, 90°-cable connection, cable 0,5m, 24V/0,8W</p>	 <p>P40.157.521</p>	
P40.157.531	2	<p>Piloto balizamiento lateral LED conexionado posterior tipo T, con 2 cables 0,2m , soporte 90°, 24V/0.8W, ADR, IP68</p> <p>LED Sidemarker Lamp, 90° bracketT-cable connection, cable 2 x 0,2m, 24V/0,8W</p>	 <p>P40.157.531</p>	
P40.157.561	2	<p>Piloto balizamiento lateral LED, conexión posterior Hotmelt 90°, soporte angular 90°, Cable 0,5m con. P&R, 24V/0.8W, ADR, IP68</p> <p>LED Sidemarker Lamp, 90° bracket, 90°-cable connection, cable 0,5m with P&R connector, 24V/0,8W</p>	 <p>P40.157.561</p>	

Pilotos Balizamiento Lateral LED

LED Sidemarker Lamp

Tipo : PRO-LINE







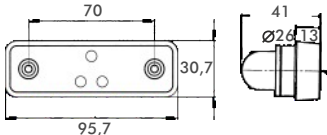
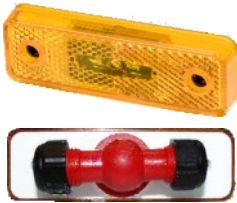
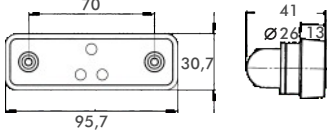

Referencia: Reference-No.	Ud. QTY	Descripción Description	Pilotos Posición LED LED Position Lamps	Esquema Drawing
P40.074.001	2	<p>Piloto Balizamiento Lateral LED PRO-LINE "Color Edition" Carcasa: ABS + PC Tulipa: Policarbonato Conexión: 0,5m puntas abiertas Voltaje: 12/24 Volt Protección: IP6K9K Montaje: Superficie o Empotrable Homolog.: ECE ADR EMV Consumo: 12V-0,3W / 24V-0,6W</p> <p>LED Position Lamp PRO-LINE „Color Edition“, Housing: ABS + PC Lens: PC Cable: 0,5m open end Voltage: 12/24 Volt Protection: IP6K9K Fixation: recessed or pendant pendant housing included Homologation: ECE approved ADR approved EMC approved Consumption: 12V-0,3W / 24V-0,6W</p>		<p>incl. carcasa incl. housing</p>
P40.074.011	2	<p>Piloto Balizamiento Lateral LED PRO-LINE "Color Edition" Carcasa: ABS + PC Tulipa: Policarbonato Transp. Conexión: 0,5m puntas abiertas Voltaje: 12/24 Volt Protección: IP6K9K Montaje: Superficie o Empotrable Homolog.: ECE ADR EMV Consumo: 12V-0,3W / 24V-0,6W</p> <p>LED Position Lamp PRO-LINE „Color Edition“, red Housing: ABS + PC Lens: PC Cable: 0,5m open end Voltage: 12/24 Volt Protection: IP6K9K Fixation: recessed or pendant pendant housing included Homologation: ECE approved ADR approved EMC approved Consumption: 12V-0,3W / 24V-0,6W</p>		<p>sin carcasa without housing</p>

Pilotos Balizamiento Lateral LED

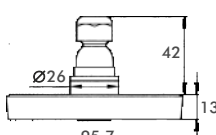
LED Sidemarker Lamp

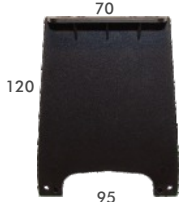
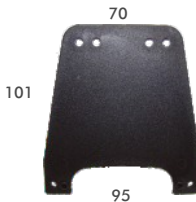

Referencia: Reference-No.	Ud. QTY	Descripción Description	Piloto Posición LED LED Sidemarker Lamps	Tecnología LED LED Technology	
P40.157.001	10	<p>Piloto balizamiento lateral LED, conexión racor PG 90°, terminales 2.8mm, 24V/0.8W, ADR, IP68</p> <p>LED Sidemarker Lamp, waterproofed housing, 90° connector with PG-screw, 2,8mm terminals</p>			
P40.157.011	10	<p>Piloto balizamiento lateral LED, conexión racor PG tipo T, terminales 2.8mm, 24V/0.8W, ADR, IP68</p> <p>LED Sidemarker Lamp, waterproofed housing, T-connector with PG-screws, 2,8mm terminals</p>			
P40.157.041	10	<p>Piloto balizamiento lateral LED, conexión racor PG recto, terminales 2.8mm, 24V/0.8W, ADR, IP68</p> <p>LED Sidemarker Lamp, waterproofed housing, straight connector with PG-screws, 2,8mm terminals</p>			
P40.157.101	10	Tulipa LED			
P40.128.254	10	Almohadilla de goma flexible			
		Flex. Support for LED SML	P40.157.101	P40.128.254	
P40.157.204	10	Conector PG 90°			
P40.157.214	10	Conector PG tipo T			
P40.157.224	10	Conector PG recto			
		Straight Connector with PG screw	P40.157.204	P40.157.214	P40.157.224
P40.157.414	10	Soporte largo angulado 90°			
P40.157.514	10	Soporte largo recto	P40.157.414		P40.157.514
		Bracket 90°, long version LED Sidemarker Lamp			
		Bracket long version for LED Sidemarker Lamp			

Pilotos Balizamiento Lateral LED

LED Sidemarker Lamp







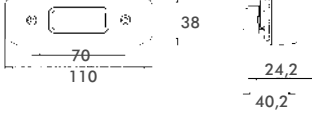

Referencia: Reference-No.	Ud. QTY	Descripción Description	Piloto Posición LED LED Sidemarker Lamps	Tecnología LED LED Technology
P40.157.021 24V	10	Piloto balizamiento lateral LED, conexión racor PG 90°, terminales 2.8mm, con soporte angular 90°, 24V/0.8W, ADR, IP68		
P40.157.221 12V	10	LED Sidemarker Lamp, waterproofed housing, 90° connector with PG-screw, 2,8mm terminals, bracket 90°		
P40.157.031 24V	10	Piloto balizamiento lateral LED, conexión racor PG tipo T, terminales 2.8mm, con soporte 90°, 24V/0.8W, ADR, IP68		
P40.157.051 24V	10	Piloto balizamiento lateral LED, conexión racor PG recto, terminales 2.8mm, con soporte angulado 90°, 24V/0.8W, ADR, IP68		
P40.157.101	10	Tulipa LED		
P40.157.314	10	Soporte angular 90°		 H: 43
P40.157.204	10	Conector PG 90°		
P40.157.214	10	Conector PG tipo T		
P40.157.224	10	Conector PG recto		
		90° Connector with PG screw		
		T-Connector with PG screw		
		Straight Connector with PG screw		
			P40.157.204	P40.157.214
				P40.157.224

Pilotos Balizamiento Lateral LED

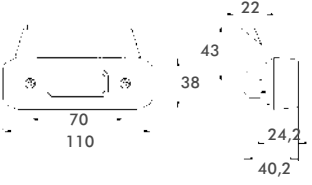
LED Sidemarker Lamp

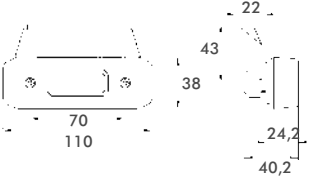
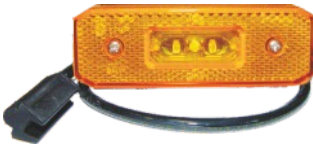
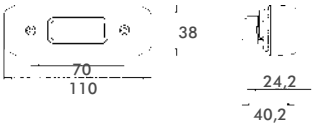

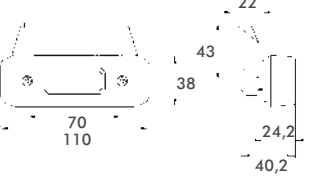
Referencia: Reference-No.	Ud. QTY	Descripción Description	Piloto Posición LED LED Sidemarker Lamps	Tecnología LED LED Technology
P40.155.001	2	<p>Piloto balizamiento lateral LED, conexión racor PG, 24V/0.55W, ADR, IP68</p> <p>LED Sidemarker Lamp with reflex reflector, cable entrance/-exit PG-Screw 24V/0,55W</p>		
A21-2601-004	2	<p>Piloto balizamiento lateral LED, conexión racor PG, con soporte angular 90°, 24V/0.55W, ADR, IP68</p> <p>LED Sidemarker Lamp incl. Bracket 90°, cable entrance/-exit PG-Screw 24V/0,55W</p>		
P90.155.021	2	<p>Piloto balizamiento lateral LED, conexión racor PG, cable 0.5m con soporte angular 90°, 24V/0.55W, ADR, IP68</p> <p>LED Sidemarker Lamp incl. Bracket 90°, cable entrance/-exit PG-Screw cable 0,5m, 24V/0,55W</p>		
P40.155.601	2	<p>Piloto balizamiento lateral LED, conexión racor PG, con cable 0.5m conector P&R, 24V/0.55W, ADR, IP68</p> <p>LED Sidemarker Lamp with PG-screw, cable 0,5m, w. P&R connector, 24V/0,8W</p>		
P40.155.621	2	<p>Piloto balizamiento lateral LED, conexión racor PG, con cable 0.5m conector P&R, soporte 90° 24V/0.55W, ADR, IP68</p> <p>LED Sidemarker Lamp with PG-screw, bracket 90°, cable 0,5m, w. P&R connector, 24V/0,8W</p>		

Pilotos Balizamiento Lateral LED

LED Sidemarker Lamp









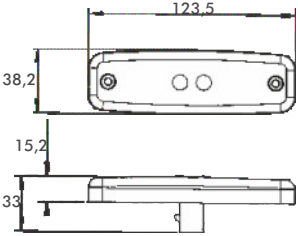

Referencia: Reference-No.	Ud. QTY	Descripción Description	Piloto Posición LED LED Sidemarker Lamps	Tecnología LED LED Technology
A31-2604-037	1	<p>Piloto balizamiento lateral LED, cable 0.5m con conector P&R, 24V/0.55W, ADR, IP68</p> <p>LED Sidemarker Lamp, cable 0.5m with Aspöck P&R connector, 24V/0.55W</p>		
A31-2604-067	1	Con cable 1.5m		
A31-2604-007	1	<p>Piloto balizamiento lateral LED, cable 0.5m con conector P&R, soporte angulado 90°, 24V/0.55W, ADR, IP68</p> <p>LED Sidemarker Lamp, cable 0.5m with Aspöck P&R connector, with bracket 90°, 24V/0.55W</p>		
A31-2604-027	1	Con cable 1.5m		
A31-2604-107	1	<p>Piloto balizamiento lateral LED, cable 0.5m con conector P&R, soporte angulado 90°, 24V/0.55W, ADR, IP68</p> <p>LED Sidemarker Lamp, cable 0.5m with Aspöck P&R connector, with bracket 90°, 24V/0.55W</p>		
A31-2604-127	1	Con cable 1.5m		
A68-5000-017	1	<p>Extensión cable 0.5m con conector P&R</p> <p>Cable 0.5m with Aspöck P&R connector</p>		
A68-5000-037	1	<p>Extensión cable 1.5m con conector P&R</p> <p>Cable 1.5m with Aspöck P&R connector</p>		

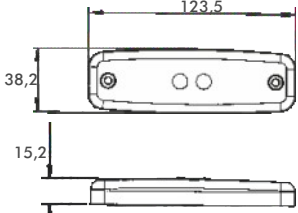
Pilotos Balizamiento Lateral LED

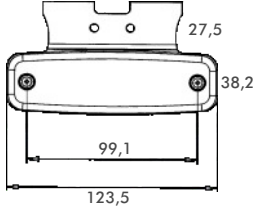
LED Sidemarker Lamp

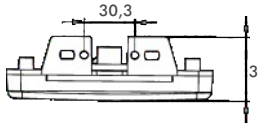







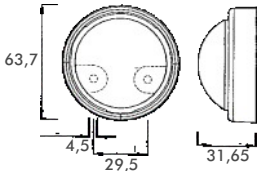
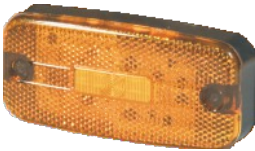
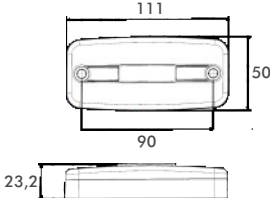

Referencia: Reference-No.	Ud. QTY	Descripción Description	Piloto Posición LED LED Sidemarker Lamps	Tecnología LED LED Technology
P40.034.001	2	Piloto balizamiento lateral LED, conector AMP Superseal 12V/24V, LED Sidemarker Lamp amber with AMP superseal connector, 12/24V		
P40.034.501	2	Piloto balizamiento lateral LED, cable plano 0.5m, 12V/24V, LED Sidemarker Lamp amber with flat cable 0,5m, 12/24V		
P40.034.521	2	Piloto balizamiento lateral LED, conector AMP Superseal, con soporte angulado 90°, 12V/24V, LED Sidemarker Lamp amber with bracket 90°, AMP superseal connector, 12/24V		
P40.034.314	2	Soporte angulado 90° Bracket 90° for LED lamp serie 034		
P50.105.005	1	Cable 0.5m con conector AMP Superseal Cable 0,5m with AMP Superseal connector for LED lamp serie 034		
P50.105.015	1	Cable 1.5m con conector AMP Superseal Cable 1,5m with AMP Superseal connector for LED lamp serie 034		
P50.079.200	1	Kit conector AMP SUPER SEAL 2 p. Connector 2-poles female, AMP SUPER SEAL		

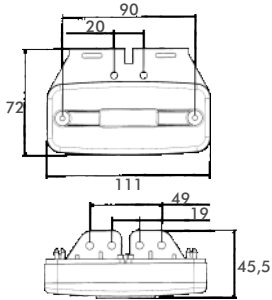
Pilotos Balizamiento Lateral LED

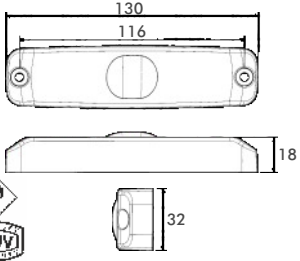
LED Sidemarker Lamp

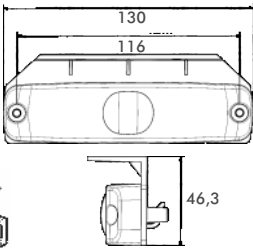

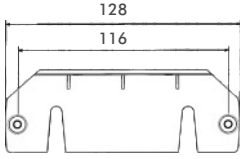



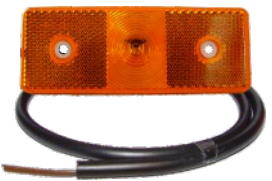
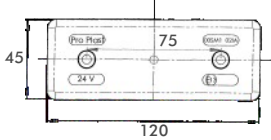

Referencia: Reference-No.	Ud. QTY	Descripción Description	Piloto Posición LED LED Sidemarker Lamps	Tecnología LED LED Technology
P40.020.001	2	<p>Piloto balizamiento lateral LED, aprueba de agua, cable 0.3m, 9-36V</p> <p>LED Sidemarker Lamp waterproofed housing, cable 0,3m, 9-36V</p>		
P40.120.001	1	<p>Piloto balizamiento lateral LED, cable 0.5m, 10-30V</p> <p>LED Sidemarker Lamp, cable 0,5m, 10-30V</p>		
P40.120.021	1	<p>Piloto balizamiento lateral LED, cable 0.5m, soporte angular 90° 10-30V</p> <p>LED Sidemarker Lamp with bracket 90°, cable 0,5m, 10-30V</p>		
P40.023.901	2	<p>Piloto balizamiento lateral LED, cable 1.5m, 12V/24V, ADR IP6K9K</p> <p>LED Sidemarker Lamp with Reflex Reflector, waterproofed housing incl. cable 1,5m, 12/24V, ADR approved</p>		
P40.023.921	2	<p>Piloto balizamiento lateral LED, cable 1.5m, con soporte angular 90°, 12V/24V, ADR, IP6K9K</p> <p>LED Sidemarker Lamp with Reflex Reflector and bracket 90°, waterproofed housing including cable 1,5m, 12/24V, ADR approved</p>		
P40.023.314	2	<p>Soporte angular 90°</p> <p>Bracket 90° for LED lamp serie 023</p>		

Pilotos Balizamiento Lateral LED

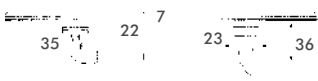
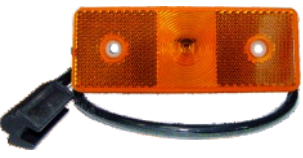
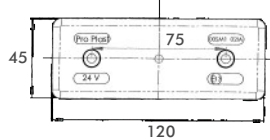
LED Sidemarker Lamp

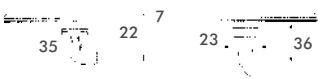
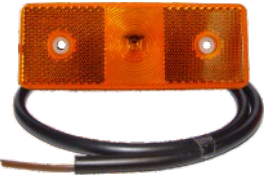
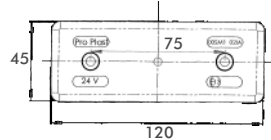
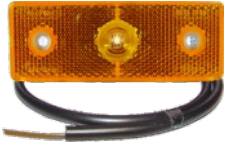
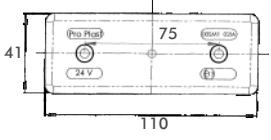









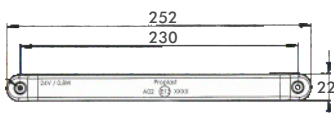

Referencia: Reference-No.	Ud. QTY	Descripción Description	Piloto Posición LED LED Sidemarker Lamps	Tecnología LED LED Technology
P40.194.001 24V	2	Piloto balizamiento lateral LED, conexión posterior Hotmelt 90°, Cab. 0,5m, 24V/1W, ADR, IP6K9K LED Sidemarker Lamp, 90°-cable connection, cable 0,5m, 24V/1W		
P40.194.011 24V	2	Piloto balizamiento lateral LED, conector posterior recto LED Sidemarker Lamp, straight-cable connection	 P40.194.001 P40.194.011	
P40.194.601 24V	2	Piloto balizamiento lateral LED, conexión posterior Hotmelt 90°, Cable 0,5m y conector P&R, 24V/1W, ADR, IP6K9K LED Sidemarker Lamp, 90°-cable connection, cable 0,5m w. P&R connector, 24V/1W		
P40.194.611 24V	2	Piloto balizamiento lateral LED, conector posterior recto LED Sidemarker Lamp, straight-cable connection	 P40.194.601 P40.194.611	
P40.194.201 12V	2	Piloto balizamiento lateral LED, conexión posterior Hotmelt 90°, Cab. 0,5m, 12V/1W, ADR, IP6K9K LED Sidemarker Lamp, 90°-cable connection, cable 0,5m, 12V/1W	 P40.194.201	
P40.016.501 24V	2	Piloto balizamiento lateral LED PRO-FLAT conexión posterior Hotmelt 90°, Cable 0,5m, IP6K9K 110x41x6,5mm, 24V/1W, ADR, LED Sidemarker Lamp, PRO-FLAT 90°-cable connection, cable 0,5m, 110x41x6,5mm, 24V/1W	 P40.016.501	
P40.194.314	10	Soporte angulado 90° 90°-Bracket for LED Sidemarker Lamp	 P40.194.314	Distancia entre taladros 30 a. 55mm 

Pilotos Balizamiento Lateral LED

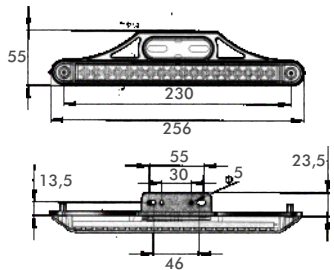
LED Sidemarker Lamp

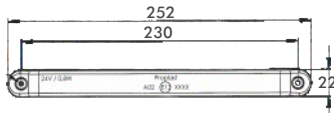
Tipo: PRO-CAN XL

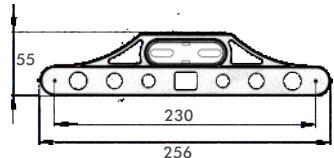



Referencia: Reference-No.	Ud. QTY	Descripción Description	Piloto Posición LED LED Sidemarker Lamps	Tecnología LED LED Technology
P40.026.091 24V	2	Piloto balizamiento lateral LED PRO-CAN XL con guía de LED, cable 0.5m, a prueba de agua, versión homologada para fijación horizontal o vertical, ADR, IP67	 Tecnología guía de luz/ Light guide technology	24V / 0,8W - 12V / 1,5W Piloto en funcionamiento 
P40.026.291 12V	2	LED Sidemarker Lamp, PRO CAN XL Light guide technology, incl. cable 0,5m, potted version		
P40.026.001 24V	2	Piloto balizamiento lateral LED PRO-CAN XL, con cable 0.5m a prueba de agua, versión homologada para fijación horizontal o vertical, ADR, IP67	 18 LEDs	
P40.026.201 12V	2	LED Sidemarker Lamp, PRO CAN XL incl. cable 0,5m, potted version		
P40.026.021 24V	2	Piloto balizamiento lateral LED PRO-CAN XL, con cable 0.5m a prueba de agua, con soporte angulado 90°, versión homologada para fijación horizontal o vertical, ADR, IP67 LED Sidemarker Lamp, PRO CAN XL incl. cable 0,5m, bracket 90° incl. reflex reflector, potted version	 18 LEDs	
P40.026.801 24V	2	Luz balizamiento lateral LED PRO-CAN XL, + intermitente, Cat. 5a, Cable 0,5m, a prueba de agua, versión homologada para fijación horizontal o vertical ADR, IP67 LED SML + Lateral LED Dir. Indicator, Lamp PRO-CAN XL, cat.5 incl. cable 0,5m, potted version, for horizontal or vertical fixation	 18 LEDs Categoría 5 + LED SML	 
P40.026.311	1	Soporte 90° para PRO-CAN XL + reflectante ambar integrado Bracket 90° with reflex reflector amber for lamp serie PRO-CAN XL	 P40.026.311	
P40.026.314	1	Soporte 90° para PRO-CAN XL Bracket 90° for lamp serie PRO-CAN XL	 P40.026.314	

Pilotos Balizamiento Lateral LED

LED Sidemarker Lamp

Tipo: PRO-CAN



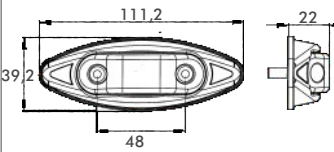
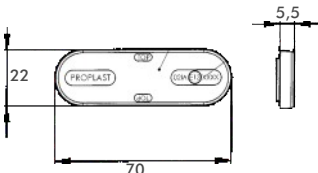









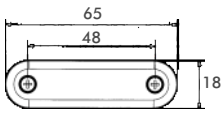

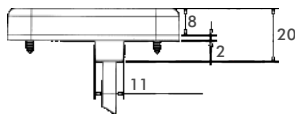

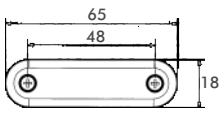
Referencia: Reference-No.	Ud. QTY	Descripción Description	Piloto Posición LED LED Sidemarker Lamps	Tecnología LED LED Technology
P40.017.001 24V	2	Piloto balizamiento lateral LED, PRO-CAN , sin reflectante, Cable 0,5m, fijación superficie, 24V/0,8W, ADR, IP 68 LED Sidemarker Lamp, PRO CAN incl. cable 0,5m, potted version, 24V/0,8W		
P40.017.201 12V	2	Piloto balizamiento lateral LED, PRO-CAN , sin reflectante, Cable 0,5m, fijación superficie, 12V/0,4W, ADR, IP 68 LED Sidemarker Lamp, PRO CAN incl. cable 0,5m, potted version, 12V/0,4W		
P40.017.021 24V	2	Piloto balizamiento lateral LED, PRO-CAN , sin reflectante, con soporte cromado Cable 0,5m, fijación superficie, 24V/0,8W, ADR, IP 68 LED Sidemarker Lamp PRO CAN amber, chrome housing, incl. cable 0,5m, potted version, 24V/0,8W		
P40.017.221 12V	2	Piloto balizamiento lateral LED, PRO-CAN , sin reflectante, con soporte cromado Cable 0,5m, fijación superficie, 12V/0,4W, ADR, IP 68 LED Sidemarker Lamp PRO CAN amber, chrome housing, incl. cable 0,5m, potted version, 12V/0,4W		
P20.017.101	2	Reflectante ámbar para piloto PRO-CAN Reflex reflector PRO-CAN amber		
P40.017.000	2	Soporte embellecedor cromado para piloto PRO-CAN Chrome housing incl. flexible support for LED Position Lamp PRO-CAN		

Pilotos Balizamiento Lateral LED

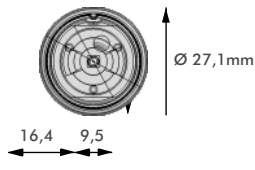
LED Sidemarker Lamp

Tipo: PRO-SLIM, PRO-PENNY, PRO FLAT

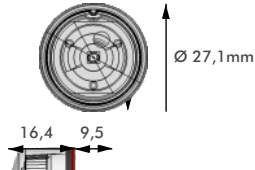

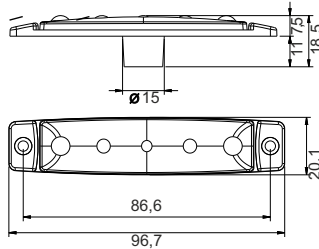





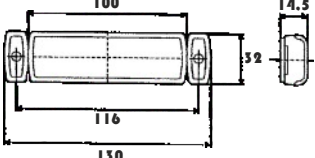

Referencia: Reference-No.	Ud. QTY	Descripción Description	Piloto Posición LED LED Sidemarker Lamps	Tecnología LED LED Technology
P40.044.001 24V	2	Piloto balizamiento lateral LED PRO-SLIM , cable 0.5m, 24V/0,8W ADR, IP6K9K LED Sidemarker Lamp PRO-SLIM amber, incl. cable 0,5m, potted version, 24V/0,8W		
P40.044.201 12V	2	Piloto balizamiento lateral LED PRO-SLIM , 12V/0,8W LED Sidemarker Lamp PRO-SLIM dito, 12V/0,8W		
P40.044.011 24V	2	Piloto balizamiento lateral LED PRO-SLIM , cable 0.5m, tulipa transparente 24V/0,8W ADR, IP6K9K LED Sidemarker Lamp PRO-SLIM amber, clear housing, incl. cable 0,5m, potted version, 24V/0,8W		
P40.044.211 12V	2	Piloto balizamiento lateral LED PRO-SLIM , 12V/0,8W LED Sidemarker Lamp PRO-SLIM dito, 12V/0,8W		
P40.002.001	2	Piloto balizamiento lateral LED PRO-PENNY , cable 0.5m, fijación con almohadilla adhesiva 3M, 12V/1.0W, 24V/1,2W, ADR, IP6K9K LED Sidemarker Lamp PRO-PENNY amber, incl. cable 0,5m, potted version, safely fixation with 3M adhesive pad, 12V/24V		12V - 1,0W / 24V - 1,2W 
P40.002.501	2	Piloto balizamiento lateral LED PRO-PENNY , cable 5,0m LED Sidemarker Lamp PRO-PENNY dito, cable 5,0m		
P40.002.011	2	Piloto balizamiento lateral LED PRO-PENNY , cable 0.5m, tulipa transparente, fijación con almohadilla adhesiva 3M, 12V/1.0W, 24V/1,2W, ADR, IP6K9K LED Sidemarker Lamp PRO-PENNY amber, clear housing, incl. cable 0,5m, potted version, safely fixation with 3M adhesive pad, 12V/24V		12V - 1,0W / 24V - 1,2W 
P40.061.001	2	Piloto balizamiento lateral LED PRO-FLAT , cable 0,25m, adhesivo 3M para fijación rápida, EMC, 12V/24V LED Sidemarker Lamp PRO-FLAT incl. cable 0,25m, potted version, adhesive pad for quick fixation, alternatively screw fixation, EMC approved, 12V/24V		

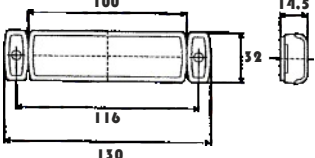
Pilotos Balizamiento Lateral LED

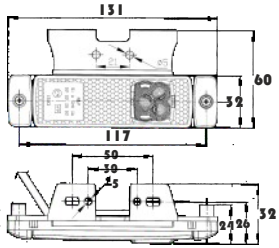
LED Sidemarker Lamp

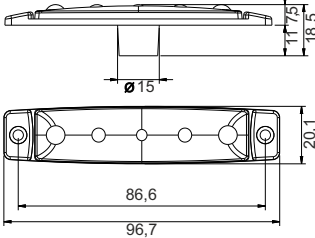

Referencia: Reference-No.	Ud. QTY	Descripción Description	Piloto Posición LED LED Sidemarker Lamps	Tecnología LED LED Technology
P40.023.001/1	1	<p>Piloto baliz. lateral LED con cable 1.5m, perfil muy plano, 24V,</p> <p>LED Sidemarker lamp, cable 1,5m very flat construction, sealed cable 24V</p>		
P40.023.001/2	1	<p>Piloto baliz. lateral LED con cable 0.5m con conector P&R, perfil muy plano, 24V,</p> <p>LED Sidemarker lamp, cable 1,5m P&R connector, very flat construction, sealed cable, 24V</p>		
P40.023.521/1	1	<p>Piloto baliz. lateral LED con cable 0.5m, perfil muy plano y soporte 90°, 24V,</p> <p>LED Sidemarker lamp, cable 1,5m very flat construction, sealed cable bracket 90°, 24V</p>		
P40.023.314	1	<p>Soporte 90°</p> <p>Bracket 90°</p>		
PA50.200.004	1	<p>Piloto balizamiento lateral 5 LEDs sin reflectante, 12V/24V</p> <p>LED Sidemarker lamp, with 6 LEDs 12V/24V</p>		
K50.200.004	1	<p>Piloto balizamiento lateral 6 LEDs sin reflectante, 24V</p> <p>LED Sidemarker lamp, with 6 LEDs 12V/24V</p>		
P40.061.011	2	<p>Piloto balizamiento lateral LED PRO-FLAT „Color Edition“ cable 0,25m, adhesivo posterior 3M para rápida fijación, EMC, 12/24V</p> <p>LED Sidemarker Lamp PRO-FLAT „Color Edition“, cable 0,25m, potted version, adhesive pad for quick fixation, alternatively screw fixation, EMC approved, 12V/24V</p>		

**PROPLAST**

FAHRZEUGBELEUCHTUNG

www.aspock.com

Catálogo 2022/2023

Pilotos Balizamiento lateral LED

Led Position Lamp

Tipo: PRO-FLAT XL













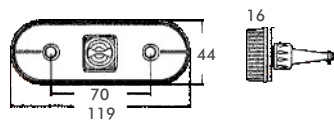

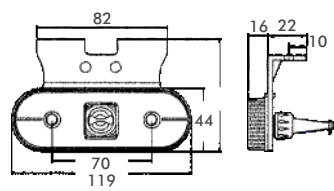

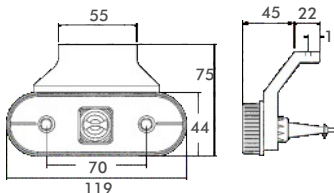
Referencia: Reference-No.	Ud. QTY	Descripción Description	Pilotos Posición LED LED Position Lamps	Esquema Drawing
P40.080.001	2	<p>Piloto Balizamiento Lateral LED PRO-FLAT XL "Color Edition" Carcasa: ABS Tulipa: Policarbonato Conexión: 0,5m puntas abiertas Voltaje: 12/24 Volt Protección: IP6K9K Montaje: Adesivo 3M fijación rápida o con tornillos Homolog.: ECE EMV Consumo: 12V-0,3W / 24V-0,6W</p> <p><i>LED Sidemarker Lamp PRO-LINE „Color Edition“</i> Housing: ABS Lens: PC Cable: 0,5m open end Voltage: 12/24 Volt Protection: IP6K9K Homologation: ECE approved EMC approved Consumption: 12V-0,3W / 24V-0,6W</p>		
P40.080.011	2	<p>Piloto Balizamiento Lateral LED PRO-FLAT XL "Color Edition" Carcasa: ABS Tulipa: Policarbonato Conexión: 0,5m puntas abiertas Voltaje: 12/24 Volt Protección: IP6K9K Montaje: Adesivo 3M fijación rápida o con tornillos Homolog.: ECE EMV Consumo: 12V-0,3W / 24V-0,6W</p> <p><i>LED Sidemarker Lamp PRO-LINE „Color Edition“</i> Housing: ABS Lens: PC Cable: 0,5m open end Voltage: 12/24 Volt Protection: IP6K9K Homologation: ECE approved EMC approved Consumption: 12V-0,3W / 24V-0,6W</p>	 <p>LEDs ámbar light emission</p>	

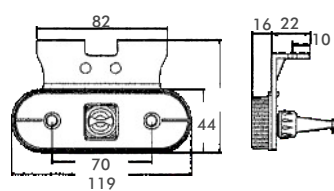
Pilotos Balizamiento Lateral LED

LED Sidemarker Lamp

Tipo: UNIPOINT













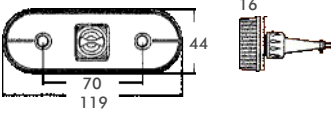

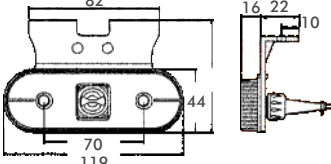

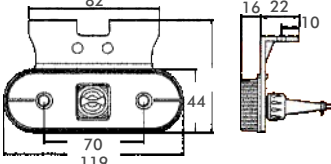

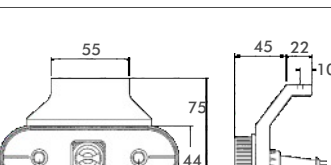

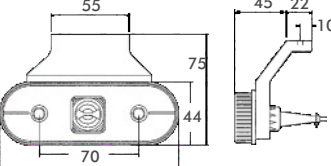
Referencia: Reference-No.	Ud. QTY	Descripción Description	Piloto Posición LED LED Sidemarker Lamps	Tecnología LED LED Technology
A21-2000-004 O A21-2000-154	1	Tulipa Piloto balizamiento lateral LED UNIPOINT , 24V/1,3W, ADR, IP69K LED Sidemarker Lamp UNIPOINT Recessed version, 24V/1,3W		
A21-2000-014	1	Kit piloto balizamiento lateral LED UNIPOINT , con soporte angular 90°, 24V/1,3W, ADR, IP69K LED Sidemarker Lamp UNIPOINT Pendant version with 90° bracket, 24V/1,3W		
A21-2000-024	1	Kit piloto balizamiento lateral LED UNIPOINT , con soporte angular flexible, 24V/1,3W, ADR, IP69K LED Sidemarker Lamp UNIPOINT Pendant version with flex. bracket, 24V/1,3W		
A21-2000-035	1	Kit piloto balizamiento lateral LED UNIPOINT , con soporte angular 90°, 24V/1,3W, ADR, IP69K, VERSION SCHMITZ LED Sidemarker Lamp UNIPOINT Pendant version with 90° bracket, 24V/1,3W, VERSION SCHMITZ	 VERSION SCHMITZ	
A15-5624-014	1	Kit conector para piloto UNIPOINT , goma con 1 orificio Connector Kit for Sidemarker Lamp UNIPOINT , grommet with one hole		
A15-5624-024	1	Kit conector para piloto UNIPOINT , goma con 2 orificios Connector Kit for Sidemarker Lamp UNIPOINT , grommet with two holes		
A15-2128-295	1	Soporte fijación rápida para piloto UNIPOINT , VERSION SCHMITZ Quick-Fixation bracket for LED-SML UNIPOINT , VERSION SCHMITZ		
A10-W100-517	1	Herramienta para sistema de conexión P&R de ASPÖCK Tool for Aspöck P&R conector system		

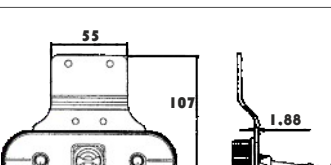
Pilotos Balizamiento Lateral LED

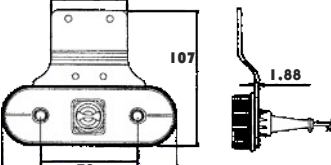
LED Sidemarker Lamp

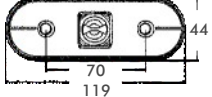
Tipo: UNIPOINT











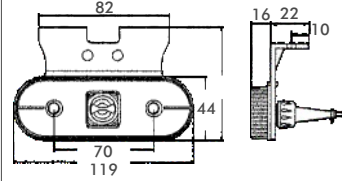

Referencia: Reference-No.	Ud. QTY	Descripción Description	Piloto Posición LED LED Sidemarker Lamps	Tecnología LED LED Technology
A31-2004-017	1	Piloto balizamiento lateral LED UNIPOINT , cable 0.5m conector P&R, 24V/1,3W, ADR, IP69K LED SML UNIPOINT , cable 0,5m with Aspöck P&R connector, recessed version, 24V/1,3W		
A31-2004-037	1	Piloto balizamiento lateral LED UNIPOINT , Cable 1,5m LED SML UNIPOINT , cable 1,5m		
A31-2064-017	1	Piloto baliz. lateral LED UNIPOINT , cable 0.5m, soporte 90° conector P&R, 24V/1,3W, ADR, IP69K LED SML UNIPOINT , cable 0,5m with Aspöck P&R connector, pendant version, 24V/1,3W		
A31-2064-037	1	Piloto balizamiento lateral LED UNIPOINT , Cable 1,5m LED SML UNIPOINT , cable 1,5m		
A31-2064-217	1	Piloto baliz. lateral LED UNIPOINT , cable 0.5m, soporte alto, conector P&R, 24V/1,3W, ADR, IP69K LED SML UNIPOINT , cable 0,5m with Aspöck P&R connector, pendant version, 24V/1,3W		
A31-2064-237	1	Piloto balizamiento lateral LED UNIPOINT , Cable 1,5m LED SML UNIPOINT , cable 1,5m		
A31-2064-417	1	Piloto baliz. lateral LED UNIPOINT , cable 0.5m, soporte alto recto, Con. P&R, 24V/1,3W, ADR, IP69K LED SML UNIPOINT , cable 0,5m with Aspöck P&R connector, pendant version, 24V/1,3W		
A31-2104-017	1	Piloto baliz. lateral LED UNIPOINT , cable 0.5m inyectado y conector P&R, 24V/1,3W, ADR, IP69K LED SML UNIPOINT , cable 0,5m with Aspöck P&R connector, flat backside, 24V/1,3W		
A31-2104-037	1	Piloto balizamiento lateral LED UNIPOINT , Cable 1,5m inyectado		
A31-2064-617	1	Piloto baliz. lateral LED UNIPOINT , cable 0.5m P&R, soporte especial LECITRAILER , ADR, IP69K LED SML UNIPOINT , cable 0,5m with Aspöck P&R connector, flat backside, 24V/1,3W		
A31-2064-637	1	Piloto balizamiento lateral LED UNIPOINT , Cable 1,5m	LECITRAILER 	

Pilotos Balizamiento Lateral LED

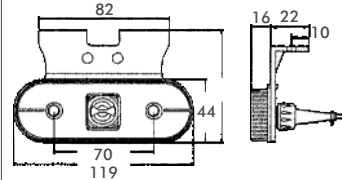
LED Sidemarker Lamp

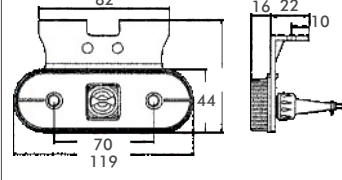
Tipo: UNIPOINT



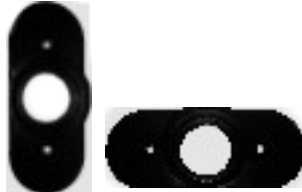





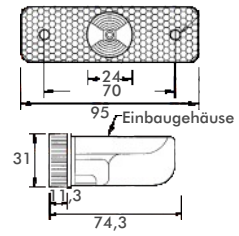

Referencia: Reference-No.	Ud. QTY	Descripción Description	Piloto Posición LED LED Sidemarker Lamps	Tecnología LED LED Technology
A31-2064-777	1	<p>Piloto baliz. lateral LED UNIPOINT, cable 0.5m P&R, soporte IPEA especial LECITRAILER, ADR, IP69K</p> <p>LED SML UNIPOINT, cable 0,5m with Aspöck P&R connector, special bracket for LECITRAILER, 24V/1,3W</p>		
A00-0000-019	1	<p>Kit piloto balizamiento lateral LED UNIPOINT, con soporte plano metálico, con cable 0.5m,</p> <p>Set LED SML UNIPOINT, cable 0,5m with Aspöck P&R connector, with metallic flat bracket</p>		
L13011	1	<p>Soporte plano metálico</p> <p>Metalic flat bracket</p>		
A00-0000-650	1	<p>Kit piloto balizamiento lateral LED UNIPOINT, con soporte tipo cocodrilo, con cable 0.5m,</p> <p>Set LED SML UNIPOINT, cable 0,5m with Aspöck P&R connector, with metallic crocodile bracket</p>		
L1300550	1	<p>Soporte metálico tipo cocodrilo</p> <p>Metalic bracket type crocodile</p>		
A00-0000-033	1	<p>Kit piloto balizamiento lateral LED UNIPOINT, con soporte tipo cocodrilo, cable 1.5m,</p> <p>LED SML UNIPOINT, cable 1,5m with Aspöck P&R connector, with a type crocodile bracket</p>		
L1300550	1	<p>Soporte metálico tipo cocodrilo</p> <p>Metalic bracket type crocodile</p>		
A00-0000-038	1	<p>Kit piloto balizamiento lateral LED UNIPOINT, con soporte de goma descentrado, salida de cable por dentro, cable 1.5m,</p> <p>Set LED SML UNIPOINT, cable 1,5m with a rubber bracket offset, cable outlet inside</p>		
L000006	1	<p>Soporte de goma descentrado</p> <p>Rubber bracket offset</p>		
A00-0000-050	1	<p>Kit piloto balizamiento lateral LED UNIPOINT, con soporte de goma centrado, salida de cable por dentro, cable 1.5m,</p> <p>Set LED SML UNIPOINT, cable 1,5m, with a rubber bracket centric, cable outlet inside</p>		
L000001	1	<p>Soporte de goma centrado</p> <p>Rubber bracket centric</p>		

Pilotos Balizamiento Lateral LED

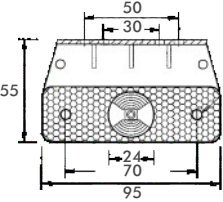
LED Sidemarker Lamp

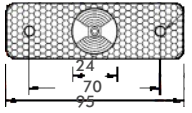
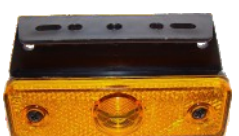
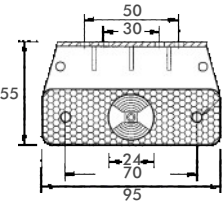
Tipo: FLATPOINT

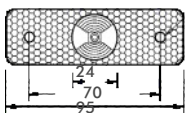







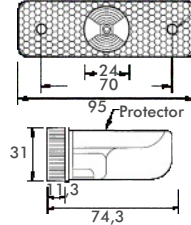

Referencia: Reference-No.	Ud. QTY	Descripción Description	Piloto Posición LED LED Sidemarker Lamps	Tecnología LED LED Technology
A21-2201-004	1	<p>Kit piloto balizamiento lateral LED FLATPOINT empotrable con conector 90°, 24V/1,3W ADR, IP68</p> <p>LED Sidemarker Lamp FLATPOINT incl. Recessed housing, bayonet joint and grommet 90°, 24V/1,3W</p>		 <p>95 Einbaugehäuse</p>
A21-2200-014	1	<p>Kit piloto balizamiento lateral LED FLATPOINT soporte 90°, con conector 90°, 24V/1,3W ADR, IP68</p> <p>LED Sidemarker Lamp FLATPOINT incl. protective housing, bayonet joint and grommet 90°, fixation bracket 90° 24V/1,3W</p>		
A21-2200-004 ○ A21-2200-064	1	<p>Tulipa LED FLATPOINT</p> <p>LED Lens for Sidemarker Lamp FLATPOINT</p>		
A21-2200-034	1	<p>Kit piloto balizamiento lateral LED FLATPOINT soporte 90°, con conector 90°, 12V/1,3W ADR, IP68</p> <p>LED Sidemarker Lamp FLATPOINT incl. protective housing, bayonet joint and grommet 90°, fixation bracket 90° 12V/1,3W</p>		
A21-2200-024	1	<p>Tulipa LED FLATPOINT 12V</p> <p>LED Lens for Sidemarker Lamp FLATPOINT 12V</p>		
A15-2122-104	1	<p>Kit conector 90°</p> <p>Connector Kit for Sidemarker Lamp FLATPOINT</p>		

Pilotos Balizamiento Lateral LED

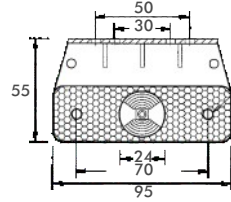
LED Sidemarker Lamp

Tipo: FLATPOINT

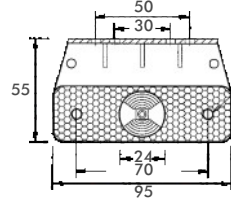

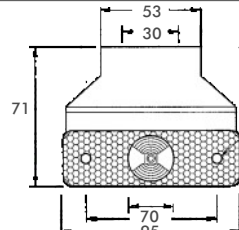

Referencia: Reference-No.	Ud. QTY	Descripción Description	Piloto Posición LED LED Sidemarker Lamps	Tecnología LED LED Technology
A31-2214-117	1	Piloto balizamiento lateral LED FLATPOINT , Cable 0,5m con conector Aspöck P&R, protector trasero, empotrable, 24V/1,3W LED SML FLATPOINT , cable 0,5m with Aspöck P&R connector, recessed version, 24V/1,3W		
A31-2214-007	1	Piloto balizamiento lateral LED FLATPOINT , Cable 0,5m con conector Aspöck P&R, soporte 90° LED SML FLATPOINT , cable 0,5m with Aspöck P&R connector, bracket 90°, 24V/1,3W		
A31-2214-017	1	Piloto LED FLATPOINT , cable 0,5m LED SML FLATPOINT , cable 0,5m		
A31-2214-027	1	Piloto LED FLATPOINT , cable 1m LED SML FLATPOINT , cable 1m		
A31-2214-037	1	Piloto LED FLATPOINT , cable 1,5m LED SML FLATPOINT , cable 1,5m		
A31-2204-087	1	Piloto balizamiento lateral LED FLATPOINT , Cable 0,25m conector Aspöck P&R, chasis, 24V/1,3W LED SML FLATPOINT , cable 0,25m with Aspöck P&R connector, recessed version, 24V/1,3W		
A31-2204-017	1	Piloto LED FLATPOINT , cable 0,5m LED SML FLATPOINT , cable 0,5m		
A31-2204-007	1	Piloto LED FLATPOINT , cable 1,5m LED SML FLATPOINT , cable 1,5m		
A31-2214-257	1	Piloto balizamiento lateral LED FLATPOINT , Cable 0,5m con conector Aspöck P&R, soporte 90°, 12V/1.3W LED SML FLATPOINT , cable 0,5m with Aspöck P&R connector, bracket 90°, 12V/1,3W		
A31-2264-007	1	Piloto balizamiento lateral LED FLATPOINT , Cable 0,25m con conector Aspöck P&R, soporte alto LED SML FLATPOINT , cable 0,25m with Aspöck P&R connector, pendant version, flexible bracket,		
A31-2264-097	1	Piloto LED FLATPOINT , cable 1,5m LED SML FLATPOINT , cable 1,5m		

Pilotos Balizamiento Lateral LED

LED Sidemarker Lamp

Tipo: FLATPOINT











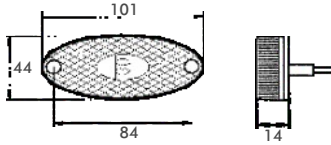

Referencia: Reference-No.	Ud. QTY	Descripción Description	Piloto Posición LED LED Sidemarker Lamps	Tecnología LED LED Technology
4081501/1	1	<p>Kit piloto balizamiento lateral LED FLATPOINT con soporte tipo cocodrilo, cable 0.25m, 24V/1,3W ADR, IP68</p> <p>Set LED Sidemarker Lamp FLATPOINT cable 0.25m P&R, with type crocodile bracket, 24V/1,3W, ADR, IP68</p>		
L1300550	1	<p>Soporte metálico tipo cocodrilo</p> <p>Metalic bracket type crocodile</p>		
A00-0000-016	1	<p>Kit piloto balizamiento lateral LED FLATPOINT con soporte plano cable 0.25m, 24V/1,3W, ADR, IP68</p> <p>Set LED Sidemarker Lamp FLATPOINT cable 0.25m P&R, with flat bracket, 24V/1,3W, ADR, IP68</p>		
L13011	1	<p>Soporte plano metálico</p> <p>Metalic flat bracket</p>		
A00-0000-031	1	<p>Kit piloto balizamiento lateral LED FLATPOINT con soporte plano cable 1.5m, 24V/1,3W, ADR, IP68</p> <p>Set LED Sidemarker Lamp FLATPOINT cable 1.5m P&R, with flat bracket, 24V/1,3W, ADR, IP68</p>		
L13011	1	<p>Soporte plano metálico</p> <p>Metalic flat bracket</p>		

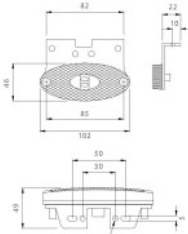
Pilotos Balizamiento Lateral LED

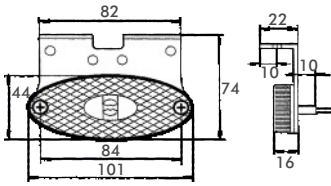
LED Sidemarker Lamp

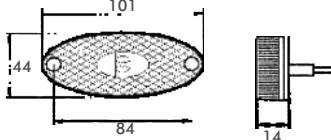
Tipo: FLATPOINT II

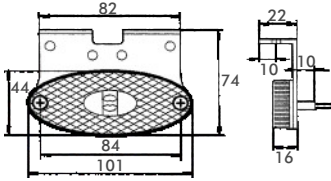

Referencia: Reference-No.	Ud. QTY	Descripción Description	Piloto Posición LED LED Sidemarker Lamps	Tecnología LED LED Technology
A31- 2304-017	1	<p>Piloto balizamiento lateral LED FLATPOINT II, cable 0,5m con conector Aspöck P&R, 24V/1,3W ADR, IP69K</p> <p>LED SML FLATPOINT II, cab. 0,5m with Aspöck P&R connector, recessed version, 24V/1,3W</p>		
A31-2304-037	1	<p>Piloto LED FLATPOINT II, Cab 1,5m</p> <p>LED SML FLATPOINT, cable 1,5m</p>		
A31-2364-017	1	<p>Piloto balizamiento lateral LED FLATPOINT II, cable 0,5m con conector Aspöck P&R, soporte 90° interior,24V/1,3W, IP69K</p> <p>LED SML FLATPOINT II, cab. 0,5m with Aspöck P&R connector, pendant version, 24V/1,3W</p>		
A31-2364-037	1	<p>Piloto LED FLATPOINT II, Cab 1,5m</p> <p>LED SML FLATPOINT, cable 1,5m</p>		
A31-2364-087	1	<p>Piloto balizamiento lateral LED FLATPOINT II, cable 0,5m con conector Aspöck P&R, soporte 90° exterior,24V/1,3W, IP69K</p> <p>LED SML FLATPOINT II, cab. 0,5m with Aspöck P&R connector, pendant version, 24V/1,3W</p>		
A31-2364-107	1	<p>Piloto LED FLATPOINT II, Cab 1,5m</p> <p>LED SML FLATPOINT, cable 1,5m</p>		
A31-2309-027	1	<p>Piloto balizamiento lateral LED FLATPOINT II, cable 0,5m con conector DC Aspöck, 12V/1,3W ADR, IP69K</p> <p>LED SML FLATPOINT II, cab. 0,5m with Aspöck DC-Connector System, recessed version, 12V/1,3W</p>		
A31-2369-047	1	<p>Piloto balizamiento lateral LED FLATPOINT II, cable 0,5m con conector DC Aspöck, soporte 90° 12V/1,3W, ADR, IP69K</p> <p>LED SML FLATPOINT II, cab. 0,5m with Aspöck DC-Connector System, pendant version, 12V/1,3W</p>		
A31-2369-067	1	<p>Piloto LED FLATPOINT II, Cab 2m</p> <p>LED SML FLATPOINT, cable 2m</p>		
A15-5976-017	1	<p>Conector sistema DC 12V</p>		
A10-W100-517	1	<p>Herramienta para sistema Aspöck DC</p> <p>Tool for Aspöck P&R conector system</p>		

A15- 5976-017

A10-W100-517

Pilotos Balizamiento Lateral LED

LED Sidemarker Lamp

Tipo: FLATPOINT II





Referencia: Reference-No.	Ud. QTY	Descripción Description	Piloto Posición LED LED Sidemarker Lamps	Tecnología LED LED Technology
A00-0000-029	1	Piloto baliz. lateral LED FLATPOINT II , cable 1.5m ASS3, soporte tipo cocodrilo, ADR, IP69K LED SML FLATPOINT II , cable 1,5m, with Aspöck P&R connector, bracket, type crocodile, 24V/1.3W		
L1300550	1	Soporte metálico tipo cocodrilo Metalic bracket type crocodile		
A00-0000-037	1	Piloto baliz. lateral LED FLATPOINT II , cable 1.5m P&R, soporte tipo cocodrilo, especial LECITRAILER, ADR, IP69K (ref. piloto A31-2364-267) LED SML FLATPOINT II , cable 1,5m, with Aspöck P&R connector, special bracket for LECITRAILER, 24V/1,3W		
L1300550	1	Soporte metálico tipo cocodrilo Metalic flat bracket		
A00-0000-137	1	Piloto baliz. lateral LED FLATPOINT II , cable 0.25m P&R, soporte tipo cocodrilo, especial LECITRAILER, ADR, IP69K (ref. piloto A31-2364-257) LED SML FLATPOINT II , cable 0,25m, with Aspöck P&R connector, special, bracket for LECITRAILER, 24V/1,3W		
L1300550	1	Soporte metálico tipo cocodrilo Metalic flat bracket		
A00-0000-091	1	Kit Piloto baliz. lateral LED FLATPOINT II , cable 1.5m P&R, soporte de goma centrado, ADR, IP69K Set LED SML FLATPOINT II , cable 0,25m with Aspöck P&R connector, rubber bracket centric, 24V/1,3W, ADR, IP69K		
L000007	1	Soporte de goma centrado		
A00-0000-131	1	Kit Piloto baliz. lateral LED FLATPOINT II , cable 1.5m P&R, soporte de goma descentrado, ADR, IP69K Set LED SML FLATPOINT II , cable 0,25m with Aspöck P&R connector, rubber bracket offset, 24V/1,3W,		
L000012	1	Soporte de goma descentrado		
A00-0000-150	1	Kit Piloto baliz. lateral LED FLATPOINT II , cable 1.5m P&R, soporte de goma descentrado, cable por fuera del tubo Set LED SML FLATPOINT II , cable 0,25m with Aspöck P&R connector, rubber bracket offset, 24V/1,3W,		
L000010	1	Soporte de goma descentrado		

Pilotos Balizamiento Lateral LED

LED Sidemarker Lamp

Tipo: UNIPOINT II VERSION SCHMITZ



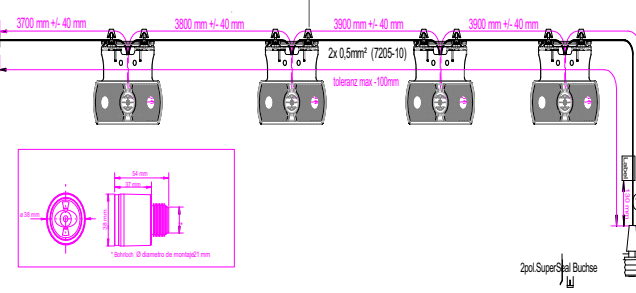
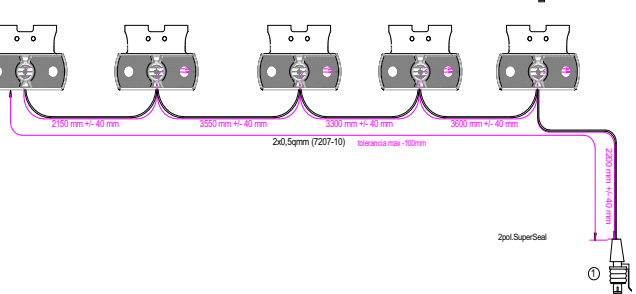



Referencia: Reference-No.	Ud. QTY	Descripción Description	Piloto Posición LED LED Sidemarker Lamps	Tecnología LED LED Technology
A31- 2464-024	1	<p>Piloto balizamiento lateral LED UNIPOINT II, 2 cables 0,5m con conector Super SEAL, versión con soporte 90°, remaches sujeción incluidos, 24V/1,3W, ADR, IP69K</p> <p>LED SML UNIPOINT II, two cables 0,5m with Super Seal connector, recessed version, 24V/1,3W ADR, IP69K</p>		
A31-2464-034	1	<p>Piloto balizamiento lateral LED UNIPOINT II, 2 cables 0,5m con conector Super SEAL, versión con soporte 90°, remaches sujeción No incluidos, 24V/1,3W, ADR, IP69K</p> <p>LED SML UNIPOINT II, two cables 0,5m with Super Seal connector, recessed version, 24V/1,3W ADR, IP69K</p>		
A87-1366-001	1	<p>Kit 4 pilotos balizamiento lateral LED UNIPOINT II, con conector Super Seal, versión con soporte 90°, remaches de sujeción incluidos, 24V/1,3W, ADR, IP69K</p> <p>LED Set SML UNIPOINT II, cable 0,5m with Super Seal Connector, recessed version, 24V/1,3W, ADR, IP69K</p>		
A87-1364-001	1	<p>Kit 4 pilotos balizamiento lateral LED UNIPOINT II, con conector Super Seal, versión con soporte 90°, remaches de sujeción NO incluidos, 24V/1,3W, ADR, IP69K</p> <p>LED Set SML UNIPOINT II, cable 0,5m with Super Seal Connector, recessed version, 24V/1,3W, ADR, IP69K</p>		

Pilotos Balizamiento Lateral LED

LED Sidemarker Lamp

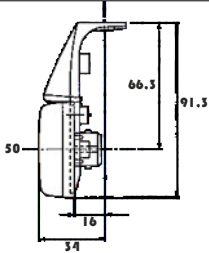
Tipo: LECIÑENA

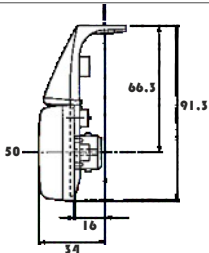

Referencia: Reference-No.	Ud. QTY	Descripción Description	Piloto Posición LED LED Sidemarker Lamps	Tecnología LED LED Technology
LÑ10100011	1	<p>Piloto balizamiento lateral LED con soporte 90°, 2 grapas metálicas para sujeción, 0.3m de cable con sistema rápido de conexión, 24V</p> <p>LED Sidemarker lamp pendant version with 90° bracket, 2 metallic fixation, cable 0.3m and fast connexion 24V</p>		
LÑ10100016	1	<p>Piloto balizamiento lateral LED con soporte 90°, 2 grapas metálicas para sujeción, 1.5m de cable con sistema rápido de conexión, 24V</p> <p>LED Sidemarker lamp pendant version with 90° bracket, 2 metallic fixation, cable 1.5m and fast connexion 24V</p>		
LÑ10100051	1	<p>Piloto balizamiento lateral LED con soporte de goma para sujeción en tubo, 0.3m de cable con sistema rápido de conexión, 24V</p> <p>LED Sidemarker lamp pendant version with rubber bracket, cable 0.3m and fast connexion 24V</p>		
LÑ10100120	1	<p>Piloto balizamiento lateral LED con soporte 90°, 2 grapas metálicas para sujeción, 0.3m de cable con sistema rápido de conexión, 24V</p> <p>LED Sidemarker lamp pendant version with 90° bracket, 2 metallic fixation, cable 0.3m and fast connexion 24V</p>		

Pilotos Balizamiento Lateral LED

LED Sidemarker Lamp

Tipo: LECIÑENA







Referencia: Reference-No.	Ud. QTY	Descripción Description	Piloto Posición LED LED Sidemarker Lamps	Tecnología LED LED Technology
LÑ10100114/1	1	<p>Kit piloto balizamiento lateral LED con cable 1.5m y sistema de conexión rápido, 24V,</p> <p>Set LED Sidemarker lamp, cable 1,5m and fast connection, 24V</p>		
LÑ10100114	1	<p>Kit piloto balizamiento lateral LED con soporte de goma para tubo, con cable 1.5m y sistema de conexión rápido, 24V,</p> <p>Set LED Sidemarker lamp, with rubber bracket, cable 1,5m and fast connection, 24V</p>		
LÑ10100121	1	<p>Piloto balizamiento lateral LED soporte 90°, con cable 1.5m y conexión rápida, 24V,</p> <p>LED Sidemarker lamp, with a bracket 90°, cable 1,5m fast connection, 24V</p>		
LÑ10100053	1	<p>Piloto balizamiento lateral LED soporte 90°, con cable 1.35m u conexión rápida, 24V,</p> <p>LED Sidemarker lamp, with a bracket 90°, cable 1,35m fast connection, 24V</p>		
LÑ10100052	1	<p>Piloto balizamiento lateral LED con cable 0.3m conexión rápida, 24V,</p> <p>LED Sidemarker lamp, with a bracket 90°, cable 0,30m fast connection, 24V</p>		
LÑ10100089	1	<p>Kit piloto balizamiento lateral LED con soporte de goma y tubo, con cable 1m y sistema de conexión rápido, 24V,</p> <p>Set LED Sidemarker lamp, with rubber bracket, cable 1,5m and fast connection, 24V</p>		

Pilotos Balizamiento Lateral LED

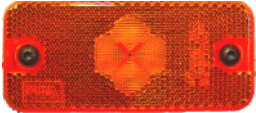
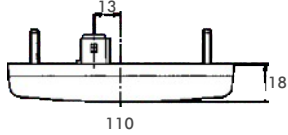
LED Sidemarker Lamp

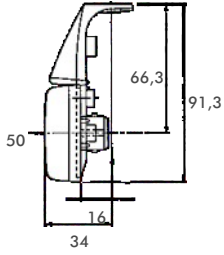





Referencia: Reference-No.	Ud. QTY	Descripción Description	Piloto Posición LED LED Sidemarker Lamps	Tecnología LED LED Technology
P40.195.001	1	Piloto balizamiento lateral LED con conector AMP, 24V LED Sidemarker Lamp, recessed version with AMP connector, 110 x 50mm, 24V		
P40.195.031	5	Piloto balizamiento lateral LED con soporte 90° con conector AMP, 24V LED Sidemarker Lamp, pendant version with AMP connector, 90° bracket, 110 x 50mm, 24V		
P50.103.000	1	Kit conector AMP cable 2m Cable 2m with AMP-connector for LED-SML		

Pilotos Balizamiento Lateral LED

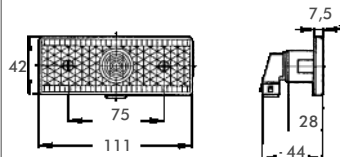
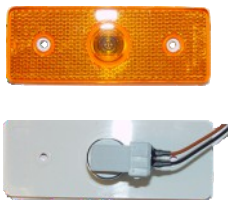
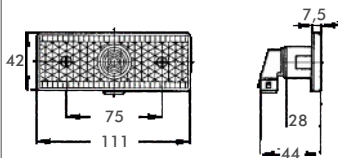
LED Sidemarker Lamp

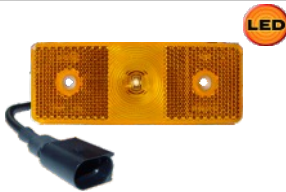
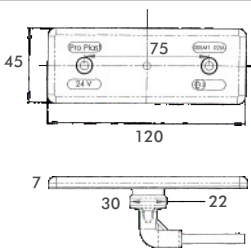
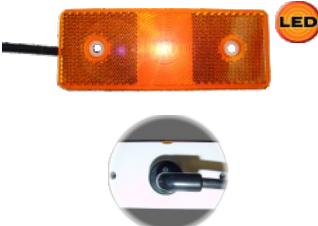
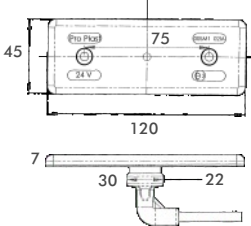

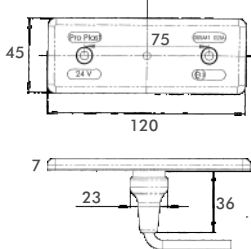





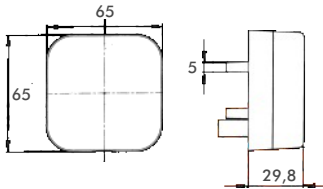

Tipo: MERCEDES BENZ

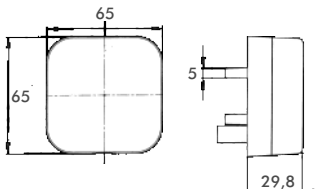
Referencia: Reference-No.	Ud. QTY	Descripción Description	Piloto Posición LED LED Sidemarker Lamps	
P40.180.001	10	Piloto balizamiento lateral para MB SK y ACTROS, 12V/24V MB Nr.: 0005444111 Sidemarker Lamp with Reflex Reflector for MB SK and ACTROS, 12V/24V		W2,1x9,5d / W3W 
P40.180.011	10	Piloto balizamiento lateral Cable 200mm, para MB SK y ACTROS, 12V/24V MB Nr.: 0005444111 Sidemarker Lamp with Reflex Reflector incl.cable 200mm MB SK and ACTROS, 12V/24V		W2,1x9,5d / W3W 
P40.180.204	10	Portalámparas para piloto MB-SML P40.180.001 Bulb Holder for MB-SML 40 180 001		
P40.180.214	10	Portalámparas para piloto MB-SML P40.180.011, cable 200mm Bulb Holder incl. cable 200mm for MB-SML 40 180 011	P40.180.204	P40.180.214
P40.194.301	2	Piloto balizamiento lateral LED conexión trasera 90°sistema Hotmelt, cable 0,2m incluye conector, 24V/1W, MB ACTROS MB Nr.: 0005445411 MB Nr.: 0005446011 LED SML, 90°-cable connection, cable 0,2m incl. connector, 24V/1W for MB ACTROS		
P40.194.001	2	Piloto balizamiento lateral LED conexión trasera 90°sistema Hotmelt, cable 0,5m, 24V/1W MB ACTROS LED Sidemarker Lamp, 90°-cable connection, cable 0,5m, 24V/1W for MB ACTROS		
P40.194.011	2	Piloto balizamiento lateral LED conexión trasera recta sistema Hotmelt, cable 0,5m, 24V/1W MB ACTROS LED Sidemarker Lamp, straight-cable connection, cable 0,5m, 24V/1W for MB ACTROS		

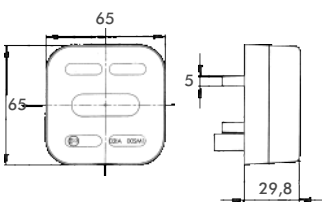
Pilotos Balizamiento Lateral LED

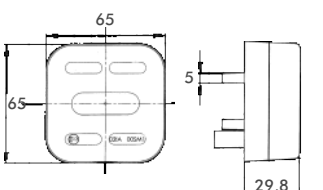
LED Sidemarker Lamp

Tipo: M.A.N.













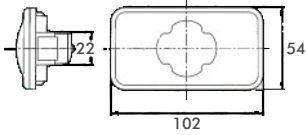

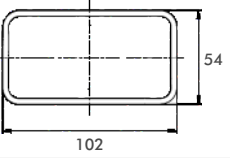

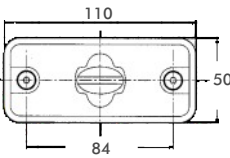

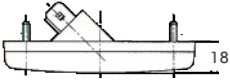
Referencia: Reference-No.	Ud. QTY	Descripción Description	Piloto Posición Sidemarker Lamps	
P40.152.001	10	Piloto balizamiento lateral 12V/24V M.A.N. Nr.: 81.25260.6048 M.A.N. Nr.: 81.25260.6088 Sidemarker Lamp with Reflex Reflector, 12V/24V		SV 8,5 / C5W 
P40.152.101	10	Tulipa para piloto M.A.N. Lens for M.A.N.-SML	incluye lámparas 24V/5W including bulb 24V/5W	
P90.152.001	2	Piloto balizamiento lateral con cable 0.5m, 12V/24V M.A.N. Nr.: 81.25260.6048 M.A.N. Nr.: 81.25260.6088 Sidemarker Lamp with Reflex Reflector, cable 0,5m, 12V/24V		SV 8,5 / C5W 
P40.152.101	10	Tulipa para piloto M.A.N. Lens for M.A.N.-SML	incluye lámparas 24V/5W including bulb 24V/5W	
P40.187.001	2	Piloto balizamiento lateral LED 24V M.A.N. Nr.: 81.25260.6105 LED Sidemarker Lamp with Reflex Reflector, 24V	 	
P40.187.101	10	Tulipa led para piloto M.A.N. Lens for M.A.N.-LED SML		
P90.187.001	2	Piloto balizamiento lateral LED con cable, 0.5m, 24V M.A.N. Nr.: 81.25260.6105 LED Sidemarker Lamp with Reflex Reflector, cable 0,5m, 24V	 	
P40.187.101	10	Tulipa led para piloto M.A.N. Lens for M.A.N.-LED SML		
P50.102.000	1	Módulo LED 24V para piloto balizamiento lateral M.A.N. P40.187.001y P90.187.001 LED Module 24V for M.A.N. Sidemarker Lamp 40187 001 and 90 187 001	   <p>Vista frontal Front view</p> <p>Vista trasera Rear view</p>	

Pilotos Balizamiento Lateral

Sidemarker Lamp

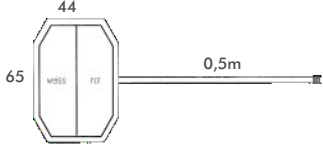
Tipo: VOLVO, SCANIA, IVECO, RENAULT, DAF

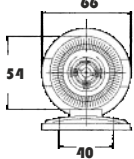

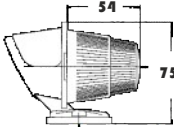







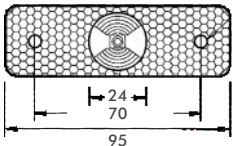

Referencia: Reference-No.	Ud. QTY	Descripción Description	Piloto Posición Sidemarker Lamps
P40.196.001	10	Piloto balizamiento lateral LED VOLVO, 24V VOLVO Nr.: 20398660 LED Sidemarker Lamp, VOLVO, 24V	  
P40.198.001	2	Piloto balizamiento lateral LED SCANIA, 24V SCANIA Nr.: 1446359 LED Sidemarker Lamp, SCANIA, 24V	  
P40.150.001	1	Piloto balizamiento lateral, 12V/24V DAF Nr.: 1302707 IVECO Nr.: 500308514 RENAULT Nr.: 5010231957	 W2, 1x9,5d / W3W 
P40.150.301	1	Piloto balizamiento lateral LED, 12V/24V IVECO Nr.: 41200664 Sidemarker Lamp IVECO, 12V/24V	 
P40.150.501	10	Portalámparas para piloto balizamiento lateral P40.150.001	
P40.150.601	10	Portalámparas para piloto balizamiento lateral IVECO P40.150.301	 P40.150.501 P40.150.601
P50.126.000	1	Cable adaptador para piloto balizamiento lateral VOLVO LED P40.196.001, < 2002 Cable Kit for VOLVO LED Sidemarkerlamp 40 196 001	
A31-6309-057	1	Piloto balizamiento lateral LED FLEXIPOINT, sistema conexión DC Aspöck, cable 0,5m, 9-33V LED Sidemarker Lamp FLEXIPOINT DC System Aspöck cable 0,5m, 9-33V	  
P40.126.001	1	Piloto balizamiento lateral para techo, sin reflectante, color carcasa negra 12V/24V	 
P40.126.011	1	Piloto balizamiento lateral para techo, sin reflectante, color carcasa cromada 12V/24V	 

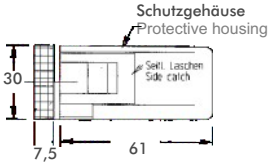
Pilotos Balizamiento Lateral

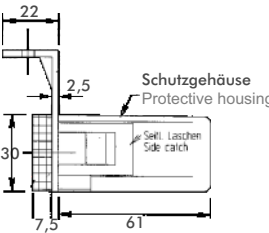
Sidemarker Lamp

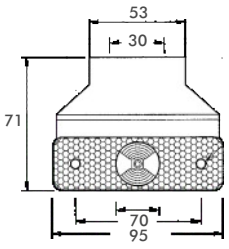
Tipo: SIDEPOINT







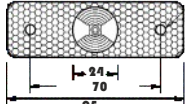

Referencia: Reference-No.	Ud. QTY	Descripción Description	Piloto Posición Sidemarker Lamps	BA 9S / T4W
A21-2801-054	1	<p>Piloto balizamiento lateral conector posterior 90°, con portalámparas y bombillas incluidas, 24V/4W, 12V/24V</p> <p>Sidemarker Lamp, w. reflector, bulbholder w. bayonet joint incl. bulb 24V/4W, 90° grommet, 12V/24V</p>		
A21-2801-064	1	<p>Piloto balizamiento lateral caja protectora y conector posterior 90°, con portalámparas y bombillas incluidas, 24V/4W, 12V/24V</p> <p>Sidemarker Lamp, w. reflector, bulbholder w. bayonet joint incl. bulb 24V/4W, 90° grommet, protective housing, 12V/24V</p>		
A21-2800-014	1	<p>Piloto balizamiento lateral conector posterior 90°, soporte angular 90°, con portalámparas y bombillas incluidas, 24V/4W, 12V/24V</p> <p>Sidemarker Lamp, w. reflector, bulbholder w. bayonet joint incl. bulb 24V/4W, 90° grommet, protective housing w. 90° bracket, 12V/24V</p>		
1	1	<p>Piloto balizamiento lateral conector posterior 90°, soporte alto 71 mm, con portalámparas y bombillas incluidas, 24V/4W, 12V/24V</p> <p>Sidemarker Lamp, w. reflector, bulbholder w. bayonet joint incl. bulb 24V/4W, 90° grommet and 90° bracket, 12V/24V</p>		
A21-2800-004	1	Tulipa ámbar		
A21-2800-074	1	Lens for Sidemarker Lamp	A21-2800-004	A11-2128-197
A11-2128-197	1	<p>Almohadilla flexible para piloto balizamiento lateral</p> <p>Flex. support for Sidemarker Lamp</p>		
P40.128.204	10	<p>Fassungsgehäuse inkl. Glühlampe für Seitenmarkierungsleuchte</p> <p>Bulbholder incl. bulb for SML</p>		
			P40.128.204	

Pilotos Balizamiento Lateral

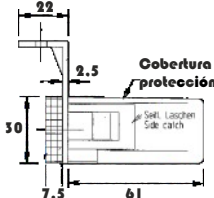
Sidemarkers Lamp

Tipo: SIDEPOINT

Referencia: Reference-No.	Ud. QTY	Descripción Description	Piloto Posición Sidemarkers Lamps	
A31-2804-177	1	<p>Piloto balizamiento lateral portalámparas 90° posterior, cable 1,5m con conector Aspöck P&R, 24V/4W, versión empotrable</p> <p>Sidemarkers Lamp with reflex reflector bulbholder w. bayonet joint incl. bulb 24V/4W, 90° grommet and cable 1.5m with Aspöck P&R connector, recessed version</p>		
A31-2814-047	1	Versión cable 0.5m		
A31-2804-197	1	Versión 12V, cable 0.25m Version 12V, cable 0.25m		
A31-2814-217	1	<p>Piloto balizamiento lateral portalámparas 90° posterior, soporte angular 90°, cable 0,25m con conector Aspöck P&R, 24V/4W, versión empotrable</p> <p>Sidemarkers Lamp with reflex reflector bulbholder w. bayonet joint incl. bulb 24V/4W, bracket 90°, cable 1.5m with Aspöck P&R connector, recessed version</p>		
A31-2814-007	1	Versión cable 0.5m		
A31-2814-017	1	Versión cable 1m		
A31-2814-027	1	Versión cable 1,5m		
A31-2814-237	1	Versión 12V, cable 0.25m Version 12V, cable 0.25m		
A00-0000-004	1	<p>Kit piloto balizamiento lateral SIDEPOINT, soporte plano metálico, cable 0,5m P&R, 24V</p> <p>Sidemarkers Lamp SIDEPOINT cable 0,5m P&R, metallic bracket, 24V</p>		
L13011	1	Soporte plano metálico		
A00-0000-018	1	<p>Kit piloto balizamiento lateral SIDEPOINT, soporte plano metálico, cable 0,5m P&R, 12V</p> <p>Sidemarkers Lamp SIDEPOINT cable 0,5m P&R, metallic bracket, 12V</p>		
L13011	1	Soporte plano metálico		
A00-0000-032	1	<p>Kit piloto balizamiento lateral SIDEPOINT, soporte plano metálico, cable 1,5m P&R, 24V</p> <p>Sidemarkers Lamp SIDEPOINT cable 1,5m P&R, metallic bracket, 24V</p>		
L13011	1	Soporte plano metálico		

Pilotos Balizamiento Lateral

Sidemarker Lamp









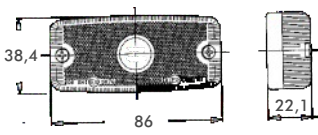

Referencia: Reference-No.	Ud. QTY	Descripción Description	Piloto Posición Sidemarker Lamps	BA 9S / T4W
P40.123.011	8	Piloto balizamiento lateral, junta de goma entre tulipa y cobertura, con pasacables racor PG posterior, 12V/24V Sidemarker Lamp with reflex reflector, rubber seal between lens and housing, 1pcs. PG-Screw, 12V/24V		
P40.124.011	6	Piloto balizamiento lateral, soporte pendular recto, junta de goma entre tulipa y cobertura, con pasacables racor PG posterior, 12V/24V Sidemarker Lamp with reflex reflector, rubber seal between lens and housing, 1pcs. PG-Screw, Flex. Bracket, 12V/24V		
P40.125.011	6	Piloto balizamiento lateral, soporte angular 90°, junta de goma entre tulipa y cobertura, con pasacables racor PG posterior, 12V/24V Sidemarker Lamp with reflex reflector, rubber seal between lens and housing, 1pcs. PG-Screw, Flex. Bracket 90°, 12V/24V		
P40.123.101	10	Tulipa ámbar Lens for Sidemarker Lamp		
P50.019.001	10	Racor PG PG-Screw		

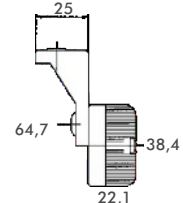
Pilotos Balizamiento Lateral

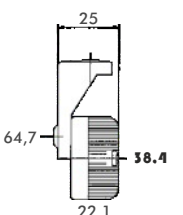
Sidemarker Lamp

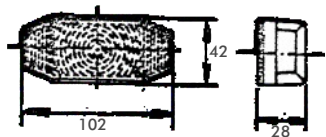



Referencia: Reference-No.	Ud. QTY	Descripción Description	Piloto Posición Sidemarker Lamps	SV 8,5 / C5W
P40.129.001	10	Piloto balizamiento lateral 12V/24V Sidemarker Lamp with reflex reflector, 12V/24V		
P40.129.021	10	Piloto balizamiento lateral con soporte 90° interior, 12V/24V Sidemarker Lamp with reflex reflector, flex. bracket 90° fitted to the back, 12V/24V		
P40.129.031	10	Piloto balizamiento lateral con soporte 90° exterior, 12V/24V Sidemarker Lamp with reflex reflector, flex. bracket 90° fitted to the front, 12V/24V		
P40.129.101	10	Tulipa ámbar Lens for Sidemarker Lamp 40 129		
P40.138.001	10	Piloto balizamiento lateral sin reflectante, 12V/24V Sidemarker Lamp 12V/24V		
P40.138.101	10	Tulipa ámbar		

Pilotos Balizamiento Lateral

Sidemarker Lamp

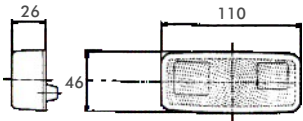

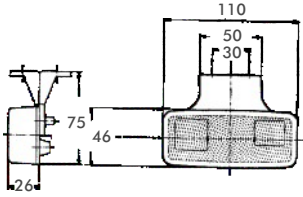
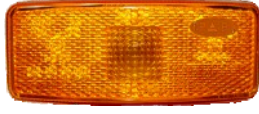
Referencia: Reference-No.	Ud. QTY	Descripción Description	Piloto Posición Sidemarker Lamps	
P40.145.001	10	Piloto balizamiento lateral 12V/24V Sidemarker Lamp with reflex refelctor 12V/24V		W2,1x9,5d / W5W 
P40.146.001	6	Piloto balizamiento lateral con soporte 90°, 12V/24V Sidemarker Lamp with reflex refelctor, flex. bracket 90° 12V/24V		W2,1x9,5d / W5W 
P40.145.101	10	Tulipa ámbar Lens for Sidemarker Lamp		

Luz de matrícula LED
Luz de matrícula
Luz interior LED
Luz interior

LED Registration Plate Lamps
Registration Plate Lamps
LED Interior Lamps
Interior Lamps

5.0 - 5.1
5.2 - 5.3
5.4 - 5.24
5.25



Pilotos Luz Matrícula LED

LED Registration Plate Lamps

Tipo: PRO-REG II



Referencia: Reference-No.	Ud. QTY	Descripción Description	Pilotos Posición LED LED Position Lamps	Esquema Drawing
P40.072.004	1	<p>Luz de Matrícula LED PRO-REG II Diseño compacto Carcasa: ABS + PC Tulipa: Policarbonato Conexión: 0,5m puntas abiertas Voltaje: 10-30 Volt Protección: IP6K9K Homolog.: ECE geprüft ADR geprüft EMV geprüft</p> <p>Consumo: 12V-1,0W/24V-1,0W Destacar: Un piloto entre las diferente medidas: - 520mm x 120mm - 340mm x 240mm - 240mm x 165mm</p> <p><i>LED Registration Plate Lamp PRO-REG II</i> Compact housing Housing: ABS + PC Lens: PC Cable: 0,5m open end Voltage: 10-30 Volt Protection: IP6K9K Homologation: ECE approved ADR approved EMC approved</p> <p>Consumption: 12V-1,0W/24V-1,0W Highlight: One Lamp for following sizes: - 520mm x 120mm - 340mm x 240mm - 240mm x 165mm</p>		
			<p>Posición de Montaje/Mounting position</p>	
P40.072.504	1	<p>Luz de Matrícula LED PRO-REG II Diseño compacto Carcasa: ABS + PC Tulipa: Policarbonato Conexión: 0,5m puntas abiertas Voltaje: 10-30 Volt Protección: IP6K9K Homolog.: ECE geprüft ADR geprüft EMV geprüft</p> <p>Consumo: 12V-1,0W/24V-1,0W Destacar: Un piloto entre las diferente medidas: - 520mm x 120mm</p> <p><i>LED Registration Plate Lamp PRO-REG II BASE</i> Incl. mounting housing Housing: ABS + PC Lens: PC Cable: 0,5m open end Voltage: 10-30 Volt Protection: IP6K9K Homologation: ECE approved ADR approved EMC approved</p> <p>Consumption: 12V-1,0W/24V-1,0W Highlight: One Lamp for following sizes: - 520mm x 120mm</p>		
			<p>Anbaulage/Mounting position</p>	

Pilotos Luz Matrícula LED

LED registration Plate Lamps

Tipo: PRO-REG



Referencia: Reference-No.	Ud. QTY	Descripción Description	Luz matrícula LED LED registration plate lamps	Tecnología LED LED Technology
P40.027.044 24V	2	<p>Luz de matrícula LED PRO-REG, diseño moderno, carcasa negra, cable 0,5m, 24V/1W, sujeción 2 tornillos M5, ADR, IP54</p> <p>LED Registration Plate Lamp PRO-REG, modern design, black housing, cable 0,5m, 24V Fixation: 2 bolts M5</p>		
P40.027.644 24V	2	<p>Luz de matrícula LED PRO-REG, diseño moderno, carcasa negra, cable 0,5m + conector P&R, 24V/1W, sujeción 2 tornillos M5, ADR, IP54</p> <p>LED Registration Plate Lamp PRO-REG, modern design, black housing, cable 0,5m + P&R connector, 24V Fixation: 2 bolts M5</p>		
P40.027.004 24V	2	<p>Luz de matrícula LED PRO-REG, diseño moderno, carcasa negra, cable 0,5m, 24V/1W, ADR, IP54</p> <p>LED Registration Plate Lamp PRO-REG, modern design, black housing, cable 0,5m, 24V</p>		
P40.027.214 12V	2	<p>Luz de matrícula LED PRO-REG, diseño moderno, carcasa negra, cable plano 0,5m 12V/1W, ADR, IP54</p> <p>LED Registration Plate Lamp PRO-REG, modern design, black housing, flat cable 0,5m, 12V</p>		
P40.008.004 12V	2	<p>Luz de matrícula LED PR-MINI-REG, con tornillos de fijación, carcasa solida y perfil pequeño, cable 0,5m 10/30V 0.8W, ECE R4&R10, IP67</p> <p>LED Registration Plate Lamp PRO-MINI-REG, screw fixation, extreme small profile, solid housing, cable 0,5m, 10/30V, 0.8W, ECE R4&R10 approved, IP67</p>		
P40.205.300 24V	1	<p>Portamatrícula PRO-CARRIER, con 2 luces de matrícula LED con sistema de conexión rápida cable 0,5m + conector P&R, 24V</p> <p>LED License Plate Carrier PRO-CARRIER, with 2 integrated LED number plate lamps, quick and easy assembling (SNAP IN), cable 0,5m + P&R connector, 24V</p>		

Pilotos Luz Matrícula LED

LED Registration Plate Lamps



Referencia: Reference-No.	Ud. QTY	Descripción Description	Luz matrícula LED LED registration plate lamps	Tecnología LED LED Technology
P40.205.508	2	Luz de matrícula LED carcasa negra, cable 0.5m, ADR, 24V LED Registration Plate Lamp black, ADR cable 0,5m, 24V		
P40.205.118	2	Carcasa negra black housing		
A36-3604-007	1	Luz de matrícula LED REGPOINT , carcasa negra, cable 0,5m + conector P&R, 24V/1W, sujeción 2 tornillos M5, ADR, IP69K LED Registration Plate Lamp REGPOINT , black housing, cable 0,5m + P&R connector, 24V Fixation: 2 bolts M5, ADR, IP69K		
A36-3604-017	1	Luz de matrícula cable 1m		
P40.114.004 24V	2	Luz de matrícula LED empotrable cable 0,5m, 24V/0,7W LED Registration Plate Lamp, cable 0,5m, recessed version, 24V		
P40.114.204 12V	2	Luz de matrícula LED empotrable cable 0,5m, 12V/0,7W LED Registration Plate Lamp, cable 0,5m, recessed version, 12V		
P40.114.244 12V	2	Luz de matrícula LED empotrable cable plano 0,5m, 12V/0,7W LED Registration Plate Lamp, flat cable 0,5m, recessed version, 12V		
P40.166.404	1	Luz de matrícula LED pequeña cable plano 0,5m, 12/24V LED Registration Plate Lamp small version, flat cable 0,5m, 12/24V		
P40.113.004	2	Luz de matrícula LED empotrable cable 0,5m, 12V/0,7W LED Registration Plate Lamp, cable 0,5m, recessed version, 12V		

Pilotos Luz Matrícula LED

LED Registration Plate Lamps



Referencia: Reference-No.	Ud. QTY	Descripción Description	Luz matrícula LED LED registration plate lamps	Tecnología LED LED Technology
P40.027.504 24V	2	Luz de matrícula y posición LED, PRO-REG , diseño moderno, cable 0,5m, 12/24V/1W, ADR, IP54 LED Rear-/Registration Plate Lamp PRO-REG , modern Design, cable 0,5m, 24V, ADR approved	   	
P40.027.544 24V	2	Luz de matrícula y posición LED, PRO-REG , diseño moderno, cable 0,5m, 24V/1W, ADR, IP54 sujección 2 tornillos M5 LED Rear-/Registration Plate Lamp PRO-REG , modern Design, cable 0,5m, 24V, ADR approved Fixation: 2 bolts M5	   	
P40.205.506	2	Luz de matrícula y posición LED, carcasa roja, ADR, cable 0,5m, 24V LED Rear-/Registration Plate Lamp ADR cable 0,5m, 24V	 	
P40.205.116	2	Tulipa roja Lens red for LED Rear-/ Registration Plate Lamp		
A26-3010-004	1	Luz de matrícula y posición, tulipa roja, 12V/24V, ADR, IP69K Rear-/Registration Plate Lamp, Lens red, 12V/24V		SV 8,5 / C5W 
A18-8630-104	1	Tulipa roja Lens red for Rear-/Registration Plate Lamp		
P40.205.006	2	Luz de matrícula y posición, tulipa roja, 12V/24V Rear-/Registration Plate Lamp, Lens red, 12V/24V		BA 15s / R5W 
P40.205.106	2	Tulipa roja Lens red for Rear-/Registration Plate Lamp		

Pilotos Luz Matrícula

Registration Plate Lamps

Referencia: Reference-No.	Ud. QTY	Descripción Description	Piloto luz matrícula Registration plate Lamps	
A36-3809-007	1	<p>Luz de matrícula LED REGPOINT, cable plano 0,8m sistema DC Aspöck, 12V/24V, ADR, IP69K</p> <p>Registration Plate Lamp black, 12V/24V</p>		
A36-3809-017	1	<p>Luz de matrícula LED REGPOINT, cable plano 1,5m sistema DC Aspöck, 12V/24V, ADR, IP69K</p> <p>Registration Plate Lamp black, 12V/24V</p>		
A38-3809-007	1	<p>Luz de matrícula LED REGPOINT, soporte alto, cable plano 0,8m sistema DC Aspöck, 12V/24V, ADR, IP69K</p> <p>Registration Plate Lamp black, 12V/24V</p>		
A36-1209-017	1	<p>Luz de matrícula, versión pequeña cable plano 0,8m sistema DC Aspöck, 12V</p> <p>Registration Plate Lamp black, 12V/24V</p>		

Pilotos Luz Matrícula

Registration Plate Lamps

Referencia: Reference-No.	Ud. QTY	Descripción Description	Piloto luz matrícula Registration plate Lamps
A36-3804-004	1	<p>Luz de matrícula LED REGPOINT, cable 0,5m sistema P&R Aspöck, 12V/24V, ADR, IP69K</p> <p>Registration Plate Lamp Regpoint, Cable 0.5m P&R connector, 12V/24V, ADR, IP69K</p>	  
A36-3804-014	1	<p>Luz de matrícula LED REGPOINT, cable 2m sistema P&R Aspöck, 12V/24V, ADR, IP69K</p> <p>Registration Plate Lamp Regpoint, Cable 2m P&R connector, 12V/24V, ADR, IP69K</p>	  
A36-3806-004	1	<p>Luz de matrícula LED REGPOINT, cable 0,5m conector 2p ASS2, 12V/24V, ADR, IP69K</p> <p>Registration Plate Lamp Regpoint, Cable 0.5m + 2p ASS2 connector, 12V/24V, ADR, IP69K</p>	  
A36-3805-004	1	<p>Luz de matrícula LED REGPOINT, cable 2m conector 2p ASS2, 12V/24V, ADR, IP69K</p> <p>Registration Plate Lamp Regpoint, Cable 2m + 2p ASS2 connector, 12V/24V, ADR, IP69K</p>	  
A36-3807-004	1	<p>Luz de matrícula LED REGPOINT, cable 0,5m conector 2p Superseal, 12V/24V, ADR, IP69K</p> <p>Registration Plate Lamp Regpoint, Cable 0.5m + 2p Superseal connector, 12V/24V, ADR, IP69K</p>	  
A36-3810-004	1	<p>Luz de matrícula LED REGPOINT, cable 0,5m conector 3p ASS3, 12V/24V, ADR, IP69K</p> <p>Registration Plate Lamp Regpoint, Cable 0.5m + 3p ASS3 connector, 12V/24V, ADR, IP69K</p>	  

Pilotos Luz Matrícula

Registration Plate Lamps

Referencia: Reference-No.	Ud. QTY	Descripción Description	Piloto luz matrícula Registration plate Lamps	
A36-3864-004	1	Luz de matrícula LED REGPOINT , cable 0,5m sistema P&R Aspöck, 12V/24V, ADR, IP69K Registration Plate Lamp Regpoint, Cable 0.5m P&R connector, 12V/24V, ADR, IP69K		 
A36-3864-014	1	Luz de matrícula LED REGPOINT , cable 2m sistema P&R Aspöck, 12V/24V, ADR, IP69K Registration Plate Lamp Regpoint, Cable 2m P&R connector, 12V/24V, ADR, IP69K		 
A36-3867-014	1	Luz de matrícula LED REGPOINT , cable 0,5m conector 2p ASS2, 12V/24V, ADR, IP69K Registration Plate Lamp Regpoint, Cable 0.5m + 2p ASS2 connector, 12V/24V, ADR, IP69K		 
A36-3867-024	1	Luz de matrícula LED REGPOINT , cable 2m conector 2p ASS2, 12V/24V, ADR, IP69K Registration Plate Lamp Regpoint, Cable 2m + 2p ASS2 connector, 12V/24V, ADR, IP69K		 
A36-3867-004	1	Luz de matrícula LED REGPOINT , cable 0,5m conector 2p Superseal, 12V/24V, ADR, IP69K Registration Plate Lamp Regpoint, Cable 0.5m + 2p Superseal connector, 12V/24V, ADR, IP69K		 
A36-3865-004	1	Luz de matrícula LED REGPOINT , cable 0,5m conector 3p ASS3, 12V/24V, ADR, IP69K Registration Plate Lamp Regpoint, Cable 0.5m + 3p ASS3 connector, 12V/24V, ADR, IP69K		 

Pilotos Luz Matrícula

Registration Plate Lamps

Referencia: Reference-No.	Ud. QTY	Descripción Description	Piloto luz matrícula Registration plate Lamps	
P40.205.008	2	Luz de matrícula, carcasa negra, 12V/24V Registration Plate Lamp black, 12V/24V		BA 15s / R5W 
A26-3000-004	1	Luz de matrícula, carcasa negra, pasacables racor PG posterior, 12V/24V, ADR, IP54 Registration Plate Lamp black, cable entrance PG-Screw 12V/24V		SV 8,5 / C5W 
A36-3004-017	1	Luz de matrícula, carcasa negra, cable 0.5m + conector P&R, 12V/24V, ADR, IP54 Registration Plate Lamp black, cable 1,5m with Aspöck P&R connector and bulb 24V/5W		
A36-3004-027	1	Luz de matrícula, cable 1m + conector P&R Aspöck,		
A36-3004-047	1	Luz de matrícula, cable 1.5m + conector P&R Aspöck,		100
A36-3000-134	1	Luz de matrícula, carcasa negra, cable 0.5m + conector 2p SUPERSEAL, 24V, ADR, IP54 Registration Plate Lamp black, cable 1,2m with SUPERSEAL 2p connector and bulb 24V/5W		SV 8,5 / C5W 
P40.210.001	2	Luz de matrícula, carcasa negra 12V/24V Registration Plate Lamp black, 12V/24V		SV 8,5 / C5W 
A26-1200-007	2	Luz de matrícula, carcasa negra, versión pequeña, sujeción 2 tornillos, 12V Registration Plate Lamp black, small version 12V		SV 8,5 / C5W 

NEW

Pilotos Luz Interior LED

LED Interior Lamp

Tipo: PRO-MINI-SPACE
Interruptor/Switch



Referencia: Reference-No.	Ud. QTY	Descripción Description	Pilotos Posición LED LED Position Lamps	Esquema Drawing
40 068 543 Regulador de Intensidad Dimmer Switch	1	<p>Luz Interior LED PRO-MINI-SPACE perfil compacto, carcasa sólida Iluminación homogénea Cubierta tipo espejo Tulipa transparente Carcasa: ABS Tulipa: PMMA Conexión: 0,5m Cable Plano Voltaje: 12/24 Volt Protección: IP6K9K Homolog.: ADR EMV Consumo: 12V-2,0W / 24V-4,0W 600 Lumen 180 cd 21 Lux Ángulo: 140° C. Temper.: 5000K</p> <p><i>LED Interior Lamp PRO-MINI-SPACE Compact profile, Solid housing Homogeneous illumination Mirrored cover Lens in clear glass Housing: ABS Lens: PMMA Cable: 0,5m flatcable Voltage: 12/24 Volt Protection: IP6K9K Homologation: ADR approved EMC approved Consumption: 12V-2,0W / 24V-4,0W Power: 600 Lumen 180 cd 21 Lux Light output: 140° Colour Temp.: 5000K</i></p>	600lm	
			<p>Interruptor Iluminado 3 Niveles de regulación</p>	<p><i>illuminated switch 3-level dimmable</i></p>
P40.068.043 Interruptor switch	1	<p>Luz Interior LED PRO-MINI-SPACE perfil compacto, carcasa sólida Iluminación homogénea Cubierta tipo espejo Tulipa transparente Carcasa: ABS Tulipa: PMMA Conexión: 0,5m Cable Plano Voltaje: 12/24 Volt Protección: IP6K9K Homolog.: ADR EMV Consumo: 12V-2,0W / 24V-4,0W 550-600 Lumen 170-180 cd 20-21 Lux Ángulo: 140° C. Temper.: 5000K</p> <p><i>LED Interior Lamp PRO-MINI-SPACE Compact profile, Solid housing Homogeneous illumination Mirrored cover Lens in clear glass Housing: ABS Lens: PMMA Cable: 0,5m flatcable Voltage: 12/24 Volt Protection: IP6K9K Homologation: ADR approved EMC approved Consumption: 12V-2,0W / 24V-4,0W Power: 550-600 Lumen 170-180 cd 20-21 Lux Light output: 140° Colour Temp.: 5000K</i></p>	550lm	
			<p>Interruptor Iluminado 3 Niveles de regulación</p>	<p><i>illuminated switch 3-level dimmable</i></p>

NEW

Pilotos Luz Interior LED

LED Interior Lamp

Tipo: PRO-MINI-SPACE DC
Interruptor / Switch

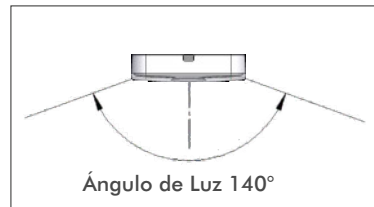

Referencia: Reference-No.	Ud. QTY	Descripción Description	Pilotos Posición LED LED Position Lamps	Esquema Drawing
P40.068.523 rojo / blanco red / white	1	<p>Luz Interior LED PRO-MINI-SPACE perfil compacto, carcasa sólida Iluminación homogénea Cubierta tipo espejo Tulipa transparente Carcasa: ABS Tulipa: PMMA Conexión: 0,5m Cable Plano Voltaje: 12/24 Volt Protección: IP6K9K Homolog.: ADR EMV Consumo: 12V-2,0W / 24V-4,0W 550 Lumen 170 cd 20 Lux Ángulo: 140° C. Temper.: 5000K</p> <p><i>LED Interior Lamp PRO-MINI-SPACE Compact profile, Solid housing Homogeneous illumination Mirrored cover Lens in clear glass Housing: ABS Lens: PMMA Cable: 0,5m flatcable Voltage: 12/24 Volt Protection: IP6K9K Homologation: ADR approved EMC approved Consumption: 12V-2,0W / 24V-4,0W Power: 550 Lumen 170 cd 20 Lux Light output: 140° Colour Temp.: 5000K</i></p>	<p>550lm</p>	
			<p>Interruptor Iluminado 3 Niveles de regulación</p>	<p><i>illuminated switch 3-level dimmable</i></p>
P40.068.553 azul / blanco blue / white	1	<p>Luz Interior LED PRO-MINI-SPACE perfil compacto, carcasa sólida Iluminación homogénea Cubierta tipo espejo Tulipa transparente Carcasa: ABS Tulipa: PMMA Conexión: 0,5m Cable Plano Voltaje: 12/24 Volt Protección: IP6K9K Homolog.: ADR EMV Consumo: 12V-2,0W / 24V-4,0W 550 Lumen 170 cd 20 Lux Ángulo: 140° C. Temper.: 5000K</p> <p><i>LED Interior Lamp PRO-MINI-SPACE Compact profile, Solid housing Homogeneous illumination Mirrored cover Lens in clear glass Housing: ABS Lens: PMMA Cable: 0,5m flatcable Voltage: 12/24 Volt Protection: IP6K9K Homologation: ADR approved EMC approved Consumption: 12V-2,0W / 24V-4,0W Power: 550 Lumen 170 cd 20 Lux Light output: 140° Colour Temp.: 5000K</i></p>	<p>550lm</p>	
			<p>Interruptor Iluminado 3 Niveles de regulación</p>	<p><i>illuminated switch 3-level dimmable</i></p>

NEW

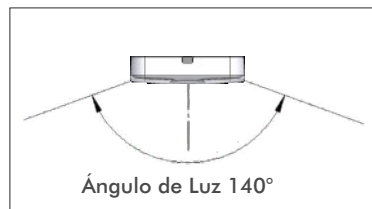

Pilotos Luz Interior LED

LED Interior Lamp

Tipo: PRO-MINI-SPACE

Referencia: Reference-No.	Ud. QTY	Descripción Description	Pilotos Posición LED LED Position Lamps	Esquema Drawing
P40.068.003	1	<p>Luz Interior LED PRO-MINI-SPACE perfil compacto, carcasa sólida Iluminación homogénea Cubierta tipo espejo Tulipa transparente Carcasa: ABS Tulipa: PMMA Conexión: 0,5m Cable Plano Voltaje: 12/24 Volt Protección: IP6K9K Homolog.: ADR EMV Consumo: 12V-2,0W / 24V-4,0W 550 Lumen 170 cd 20 Lux Ángulo: 140° C. Temper.: 5000K</p> <p><i>LED Interior Lamp PRO-MINI-SPACE Compact profile, Solid housing Homogeneous illumination Mirrored cover Lens in clear glass Housing: ABS Lens: PMMA Cable: 0,5m flatcable Voltage: 12/24 Volt Protection: IP6K9K Homologation: ADR approved EMC approved Consumption: 12V-2,0W / 24V-4,0W Power: 550 Lumen 170 cd 20 Lux Light output: 140° Colour Temp.: 5000K</i></p>	<p>550lm</p>	
P40.068.083 24 Volt	1	<p>Luz Interior LED PRO-MINI-SPACE ECO perfil compacto, carcasa sólida Iluminación homogénea Tulipa transparente Carcasa: ABS Tulipa: PMMA Conexión: 0,5m Cable Plano Voltaje: 12/24 Volt Protección: IP6K9K Homolog.: ADR EMV Consumo: 12V-2,0W / 24V-4,0W 500 Lumen 150 cd 17 Lux Ángulo: 140° C. Temper.: 5000K</p>	<p>500lm</p>	
P40.068.283 12 Volt	1	<p><i>LED Int. Lamp PRO-MINI-SPACE ECO Compact profile, Solid housing Homogeneous illumination Lens in clear glass Housing: ABS Lens: PMMA Cable: 0,5m flatcable Voltage: 12 Volt or 24 Volt Protection: IP6K9K Homologation: ADR approved EMC approved Consumption: 12V-2,0W / 24V-4,0W Power: 500 Lumen 150 cd 17 Lux Light output: 140° Colour Temp.: 5000K</i></p>		

NEW

Pilotos Luz Interior LED

LED Interior Lamp

Tipo: PRO-MINI-SPACE
Sensor de Presencia/Motion Sensor



Referencia: Reference-No.	Ud. QTY	Descripción Description	Pilotos Posición LED LED Position Lamps	Esquema Drawing
P40.068.073	1	<p>Luz Interior LED PRO-MINI-SPACE PIR-sensor, perfil compacto, carcasa sólida, Iluminación homogénea Cubierta tipo espejo Tulipa transparente Carcasa: ABS Tulipa: PMMA Conexión: 0,5m Cable Plano Voltaje: 12/24Volt Protección: IP6K9K Homolog.: ADR EMV Consumo: 12V-2,0W / 24V-4,0W 600 Lumen 180 cd 21 Lux Ángulo: 140° C. Temper.: 5000K</p> <p><i>LED Interior Lamp PRO-MINI-SPACE PIR-Sensor Compact profile, Solid housing Homogeneous illumination Mirrored cover, Lens in clear glass Housing: ABS Lens: PMMA Cable: 0,5m flatcable Voltage: 12/24 Volt Protection: IP6K9K Homologation: ADR approved EMC approved Consumption: 12V-2,0W / 24V-4,0W Power: 600 Lumen 180 cd 21 Lux Light output: 140° Colour Temp.: 5000K</i></p>	<p>600lm</p> <p>PIR Sensor</p>	
Area de Reconocimiento/Recognizing area				
P40.068.873 24 Volt	1	<p>Luz Interior LED PRO-MINI-SPACE ECO PIR- sensor, perfil compacto, carcasa sólida, Iluminación homogénea Tulipa transparente Carcasa: ABS Tulipa: PMMA Conexión: 0,5m Cable Plano Voltaje: 12/24 Volt Protección: IP6K9K Homolog.: ADR EMV Consumo: 12V-2,0W / 24V-4,0W 500 Lumen 150 cd 17 Lux Ángulo: 140° C. Temper.: 5000K</p>	<p>PIR Sensor</p>	
P40.068.973 12 Volt	1	<p>Luz Interior LED PRO-MINI-SPACE ECO PIR-Sensor Compact profile, Solid housing Homogeneous illumination Lens in clear glass Housing: ABS Lens: PMMA Cable: 0,5m flatcable Voltage: 12 Volt or 24 Volt Protection: IP6K9K Homologation: ADR approved EMC approved Consumption: 12V-2,0W / 24V-4,0W Power: 500 Lumen 150 cd 17 Lux Light output: 140° Colour Temp.: 5000K</p>	<p>PIR Sensor</p>	
Area de Reconocimiento/Recognizing area				

Pilotos Luz Interior LED

LED Interior Lamp

Tipo: PRO-ZONE

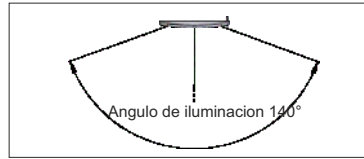







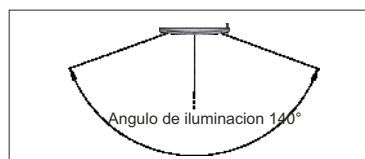

Referencia: Reference-No.	Ud. QTY	Descripción Description	Luz Interior LED LED Interior lamps	Tecnología LED LED Technology
P40.056.003 24V	1	<p>Piloto interior LED PRO-ZONE, Alta uniformidad y propagación de luz gracias a la tulipa en ópalo, Diseño plano 14,5mm de altura, Carcasa de plástico, cable 0.3m 0,3m, ADR., IP6K9K, 24V</p> <p>LED Interior Lamp PRO-ZONE, homogeneous, glare-free illumination, thanks to the lens in opal optic, very low profile, height 14,5mm, plastic housing with cable 0,3m, ADR-appr., IP6K9K, 24V</p>	<p>1700lm</p> 	<p>Iluminación sin deslumbramiento</p> 
P40.056.043 24V	1	<p>Piloto interior LED PRO-ZONE, con Sensor-interruptor táctil, Alta uniformidad y propagación de luz gracias a la tulipa en ópalo, Diseño plano 14,5mm de altura, Carcasa de plástico, cable 0.3m 0,3m, ADR., IP6K9K, 24V</p> <p>LED Interior Lamp PRO-ZONE, with Sensor-Touch switch, homogeneous, glare-free illumination thanks to the lens in opal optic, very low profile, height 14,5mm, plastic housing with cable 0,3m, ADR-appr., IP6K9K, 24V</p>	<p>1700lm</p>  <p>Sensor-Interruptor táctil</p>	<p>Iluminación sin deslumbramiento</p> 

Pilotos Luz Interior LED

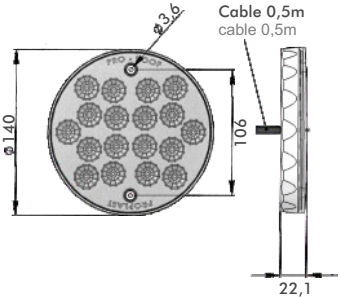
LED Interior Lamp

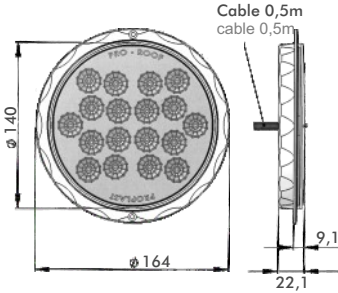
Tipo: PRO-ROOF

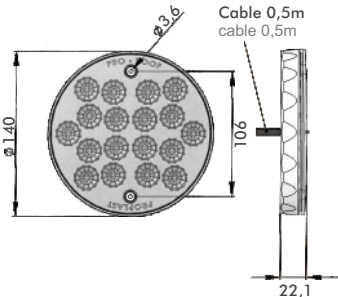

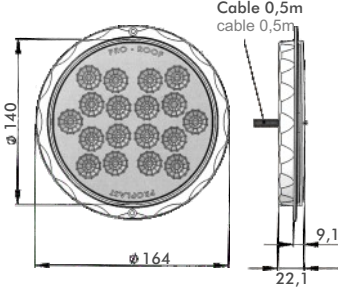
Referencia: Reference-No.	Ud. QTY	Descripción Description	Luz Interior LED LED Interior lamps	Tecnología LED LED Technology
P40.037.023 24V	1	<p>Piloto interior LED PRO-S-ROOF, 18 LED's alta potencia y tecnología espejo brillante, Carcasa exterior de plástico con cable 0,5m, versión superficie, 24V/7,5W, IP6K9K</p> <p>LED Interior Lamp PRO-S-ROOF, 18 High Power LED's, plastic housing with cable 0,5m, pendant version, 24V, IP6K9K</p>	<p>1100lm</p> 	
P40.037.033 24V	1	<p>Piloto interior LED PRO-S-ROOF, 18 LED's alta potencia y tecnología espejo brillante, Carcasa exterior de plástico con cable 0,5m, versión empotrable, 24V/7,5W, IP6K9K</p> <p>LED Interior Lamp PRO-S-ROOF, 18 High Power LED's, plastic housing with cable 0,5m, recessed version, 24V, IP6K9K</p>	<p>1100lm</p> 	
P40.037.003 24V	1	<p>Piloto interior LED PRO-S-ROOF, 18 LED's alta potencia y tecnología espejo brillante, Carcasa exterior de plástico con cable 0,5m, versión superficie, 24V/2,5W, IP6K9K</p> <p>LED Interior Lamp PRO-ROOF, 18 High Power LED's, plastic housing with cable 0,5m, pendant version, 24V, IP6K9K</p>	<p>630lm</p> 	
P40.037.013 24V	1	<p>Piloto interior LED PRO-S-ROOF, 18 LED's alta potencia y tecnología espejo brillante, Carcasa exterior de plástico con cable 0,5m, versión empotrable, 24V/2,5W, IP6K9K</p> <p>LED Interior Lamp PRO-ROOF, 18 High Power LED's, plastic housing with cable 0,5m, recessed version, 24V, IP6K9K</p>	<p>630lm</p> 	

NEW



PROPLAST

FAHRZEUGBELEUCHTUNG
www.aspock.com
Catálogo 2022/2023

Pilotos Luz Interior LED

LED Interior Lamp

Tipo: PRO-CAP
Sensor de Presencia /Motion Sensor

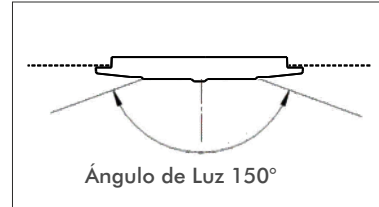







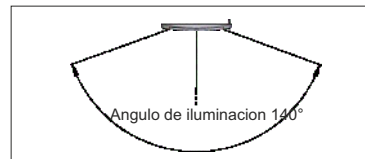

Referencia: Reference-No.	Ud. QTY	Descripción Description	Pilotos Posición LED LED Position Lamps	Esquema Drawing
P40.077.073	1	<p>Luz Interior LED PRO-CAP PIR-Sensor Iluminación homogénea Carcasa: PC+Aluminio Tulipa: Policarbonato Conexión: 0,15m Voltaje: 10-30 Volt Protección: IP6K9K Homolog.: EMV Consumo: 12V-17,0W / 24V-17,0W 1190 Lumen 460 cd 51 Lux Ángulo: 150° C. Temper.: 4500-5000K</p> <p><i>LED Interior Lamp PRO-CAP PIR-Sensor Homogeneous illumination Housing: PC+Aluminium Lens: PC Cable: 0,15m Voltage: 10-30 Volt Protection: IP6K9K Homologation: EMC approved Consumption: 12V-17,0W / 24V-17,0W Power: 1190 Lumen 460 cd 51 Lux Light output: 150° Colour Temp.: 4500-5000K</i></p>	<p>1190lm</p> <p>PIR Sensor</p>	
P40.077.003 VERSION ESTANDAR	1	<p>Luz Interior LED Iluminación homogénea Carcasa: PC+Aluminio Tulipa: Policarbonato Conexión: 0,15m Voltaje: 10-30 Volt Protección: IP6K9K Homolog.: EMC Consumo: 12V-17,0W / 24V-17,0W 1190 Lumen 460 cd 51 Lux Ángulo: 150° C. Temper.: 4500-5000K</p> <p><i>LED Interior Lamp Homogeneous illumination Housing: PC+Aluminium Lens: PC Cable: 0,15m Voltage: 10-30 Volt Protection: IP6K9K Homologation: EMC approved Consumption: 12V-17,0W / 24V-17,0W Power: 1190 Lumen 460 cd 51 Lux Light output: 150° Colour Temp.: 4500-5000K</i></p>	<p>Area de Reconocimiento /Recognizing area</p>	
P40.073.003	1	<p>Luz interior LED PRO-TWIN-CAN, homogénea, perfil bajo, Carcasa PVC, ADR., IP6K9K, EMV, 12/24V, versión superficie Conexión: Cable plano 0,5m Potencia: 1700 Lumen 285 cd 33 Lux Ángulo: 140° Color temp.: 5000K</p> <p><i>LED Interior Lamp PRO-TWIN-CAN, homogeneous, low profile, plastic housing, ADR-appr. IP6K9K, EMC approved, 12/24V, pendant version Connection: flat cable 0,5m</i></p>	<p>900lm</p>	
40.073.903	1	<p>Luz interior LED PRO-TWIN-CAN, homogénea, perfil bajo, Carcasa PVC, ADR., IP6K9K, EMV, 12/24V, versión empotrable Conexión: Cable plano 0,5m Potencia: 1700 Lumen 285 cd 33 Lux Ángulo: 140° Color temp.: 5000K</p> <p><i>LED Interior Lamp PRO-TWIN-CAN, homogeneous, low profile, plastic housing, ADR-appr. IP6K9K, EMC approved, 12/24V, recessed version Connection: flat cable 0,5m</i></p>	<p>900lm</p>	

Pilotos Luz Interior LED

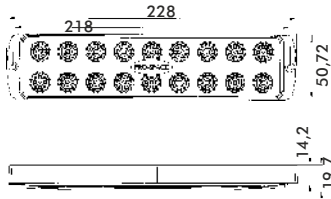
LED Interior Lamp

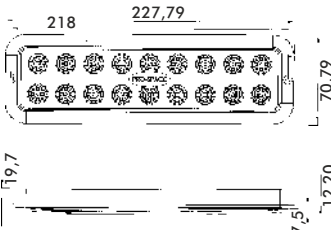
Tipo: PRO-SPACE

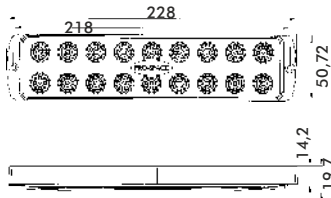

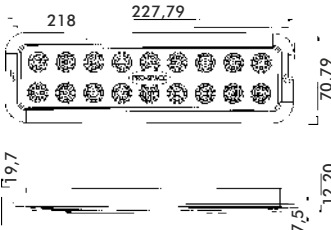





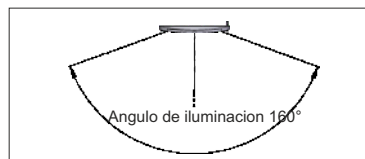

Referencia: Reference-No.	Ud. QTY	Descripción Description	Luz Interior LED LED Interior lamps	Tecnología LED LED Technology
P40.047.023 24V	1	<p>Piloto interior LED PRO-S-SPACE, 18 LED`s alta potencia y tecnología espejo brillante, Carcasa exterior de plástico con cable 0,5m, versión superficie, 24V/8W, IP6K9K</p> <p>LED Interior Lamp PRO-S-SPACE, 18 High Power LED`s, plastic housing with cable 0,5m, pendant version, 24V, IP6K9K</p>	1100lm 	
P40.047.033 24V	1	<p>Piloto interior LED PRO-S-SPACE, 18 LED`s alta potencia y tecnología espejo brillante, Carcasa exterior de plástico con cable 0,5m, versión empotrable, 24V/8W, IP6K9K</p> <p>LED Interior Lamp PRO-S-SPACE, 18 High Power LED`s, plastic housing with cable 0,5m, recessed version, 24V, IP6K9K</p>	1100lm 	
P40.047.233 12V	1	<p>Piloto interior LED PRO-S-SPACE, 12V/8W</p> <p>LED Interior Lamp PRO-S-SPACE, 12V</p>		
P40.047.003 24V	1	<p>Piloto interior LED PRO-S-SPACE, 18 LED`s alta potencia y tecnología espejo brillante, Carcasa exterior de plástico con cable 0,5m, versión superficie, 24V/2,5W, IP6K9K</p> <p>LED Interior Lamp PRO-SPACE, 18 High Power LED`s, plastic housing with cable 0,5m, pendant version, 24V, IP6K9K</p>	630lm 	
P40.047.013 24V	1	<p>Piloto interior LED PRO-S-SPACE, 18 LED`s alta potencia y tecnología espejo brillante, Carcasa exterior de plástico con cable 0,5m, versión empotrable, 24V/2,5W, IP6K9K</p> <p>LED Interior Lamp PRO-SPACE, 18 High Power LED`s, plastic housing with cable 0,5m, recessed version, 24V, IP6K9K</p>	630lm 	

Pilotos Luz Interior LED

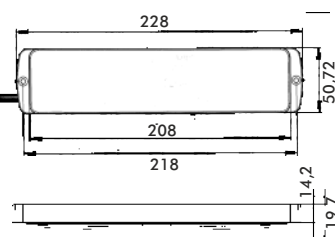
LED Interior Lamp

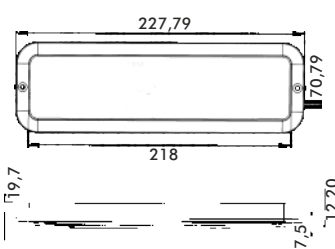
Tipo: PRO-S-SPACE opal
PRO-S-ROOF opal

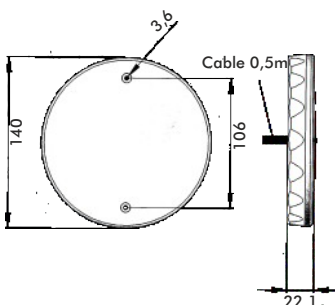

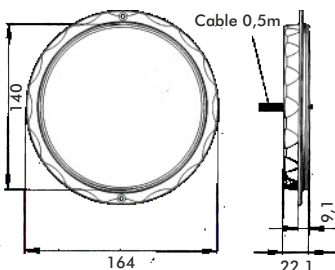
Referencia: Reference-No.	Ud. QTY	Descripción Description	Luz Interior LED LED Interior lamps	Tecnología LED LED Technology
P40.047.043 24V	1	<p>Piloto interior LED PRO-S-SPACE, 18 LED`s alta potencia y luz suave, iluminación homogénea, Carcasa exterior de plástico con cable 0,5m, versión superficie, 24V/8W, IP6K9K</p> <p>LED Interior Lamp PRO-S-SPACE opal, 18 High Power LED`s, soft, homo-geneous illumination, plastic housing with cable 0,5m, pendant version, 24V, IP6K9K</p>	<p>1000lm</p> 	<p>Iluminación sin deslumbramiento</p> 
P40.047.053 24V	1	<p>Piloto interior LED PRO-S-SPACE, 18 LED`s alta potencia y luz suave, iluminación homogénea, Carcasa exterior de plástico con cable 0,5m, versión empotrable,, 24V/8W, IP6K9K</p> <p>LED Interior Lamp PRO-S-SPACE opal, 18 High Power LED`s, soft, homo-geneous illumination, plastic housing with cable 0,5m, recessed version, 24V, IP6K9K</p>	<p>1000lm</p> 	<p>Iluminación sin deslumbramiento</p> 
P40.037.043 24V	1	<p>Piloto interior LED PRO-S-ROOF, 18 LED`s alta potencia y luz suave, iluminación homogénea, Carcasa exterior de plástico con cable 0,5m, versión superficie, 24V/8W, IP6K9K</p> <p>LED Interior Lamp PRO-S-ROOF opal, 18 High Power LED`s, soft, homogeneous illumination, plastic housing with cable 0,5m, pendant version, 24V, IP6K9K</p>	<p>1000lm</p> 	<p>Iluminación sin deslumbramiento</p> 
P40.037.053 24V	1	<p>Piloto interior LED PRO-S-ROOF, 18 LED`s alta potencia y luz suave, iluminación homogénea, Carcasa exterior de plástico con cable 0,5m, versión empotrable,, 24V/8W, IP6K9K</p> <p>LED Interior Lamp PRO-S-ROOF opal, 18 High Power LED`s, soft, homogeneous illumination, plastic housing with cable 0,5m, recessed version, 24V, IP6K9K</p>	<p>1000lm</p> 	<p>Iluminación sin deslumbramiento</p> 

Pilotos Luz Interior LED

LED Interior Lamp

Tipo: PRO-MINI-ROOF

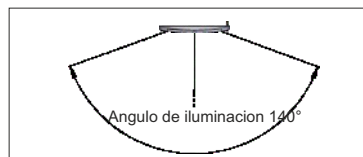







Referencia: Reference-No.	Ud. QTY	Descripción Description	Luz interior LED LED interior lamps	Tecnología LED LED Technology
P40.046.023 24V	1	<p>Piloto interior LED PRO-M-ROOF, 6 LED's alta potencia y tecnología espejo brillante, Carcasa exterior de plástico con cable 0,5m, versión superficie, 24V/5W, IP6K9K</p> <p>LED Interior Lamp PRO-M-ROOF, 6 Power LED's, plastic housing with cable 0,5m, pendant version, 24V, IP6K9K</p>	370lm	
P40.046.223 12V	1	<p>Piloto interior LED PRO-M-ROOF, 12V/5W</p> <p>LED Interior Lamp PRO-M-ROOF, 12V</p>		
P40.046.003 24V	1	<p>Piloto interior LED PRO-M-ROOF, 6 LED's alta potencia y tecnología espejo brillante, Carcasa exterior de plástico con cable 0,5m, versión superficie, 24V/3W, IP6K9K</p> <p>LED Interior Lamp PRO-M-ROOF, 6 High Power LED's, plastic housing with cable 0,5m, pendant version, 24V, IP6K9K</p>	370lm	
P40.046.203 12V	1	<p>Piloto interior LED PRO-M-ROOF, 12V/3W</p> <p>LED Interior Lamp PRO-M-ROOF, 12V</p>		
P40.046.013 24V	1	<p>Piloto interior LED PRO-M-ROOF, 6 LED's alta potencia y tecnología espejo brillante, Carcasa exterior de plástico con cable 0,5m, versión empotrable, 24V/3W, IP6K9K</p> <p>LED Interior Lamp PRO-M-ROOF, 6 High Power LED's, plastic housing with cable 0,5m, recessed version, 24V, IP6K9K</p>	370m	
P40.046.213 12V	1	<p>Piloto interior LED PRO-M-ROOF, 12V/3W</p> <p>LED Interior Lamp PRO-M-ROOF, 12V</p>		

Pilotos Luz Interior LED

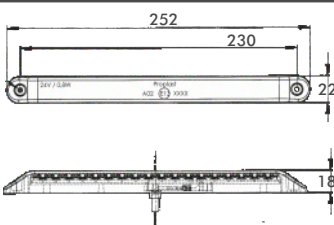
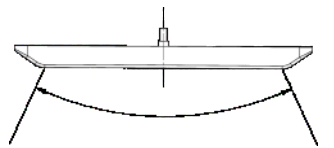
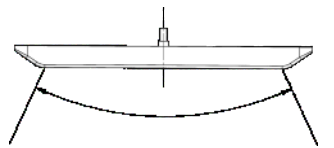
LED Interior Lamps

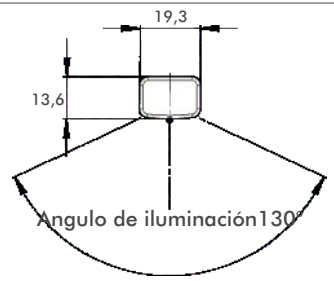
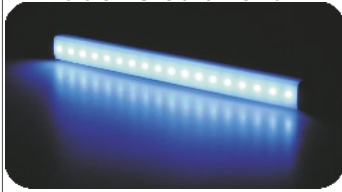
Tipo: PRO-IN
PRO-STRIPE ECO



Referencia: Reference-No.	Ud. QTY	Descripción Description	Luz Interior LED LED Interior lamps	Tecnología LED LED Technology
P40.035.003 24V	1	Piloto interior LED PRO-IN , 18 LED´s alta potencia, iluminación blanca, carcasa exterior a prueba de agua, cable 0,5m, 24V/0,8W, IP67 LED Interior Lamp PRO-IN , 18 high power LEDs, white illumination, housing complete potted, 24V/0,8W, cable 0,5m, IP67	280lm 	 
P40.035.203 12V	1	Piloto interior LED PRO-IN , 12V LED Interior Lamp PRO-IN , 12V		 Angulo de iluminación 50°
P40.048.085 24V	1	Piloto interior LED PRO-STRIPE ECO 1 blue , 222mm, 18 LEDs alta potencia, carcasa exterior de aluminio, con cable 0,3m, versión superficie, 24V/2,2W, ADR, IP6K9K LED Interior Lamp PRO-STRIPE ECO 1 blue , 222mm, 18 POWER- LED´s, cabel 0,3m, quick fixation with adhesive pad, IP6K9K appr., ADR, 24V/2,2W		 Piloto en funcionamiento 
P40.048.000	1	Kit soportes PRO-STRIPE ECO , incluye tornillos Mounting Kit PRO-STRIPE ECO incl. screws		
P40.048.100	1	Kit soportes PRO-STRIPE ECO , incluye tornillos y salida de cable Mounting Kit PRO-STRIPE ECO with cable outbreaks, incl. screws		 con salida de cable/ with cable outbreaks

Pilotos Luz Interior LED

LED Interior Lamps

Tipo: Centralita PIR-Sensor



Esquemas de Montaje de la Centralita PIR-Sensor Fitting possibilities with Central PIR-Sensor

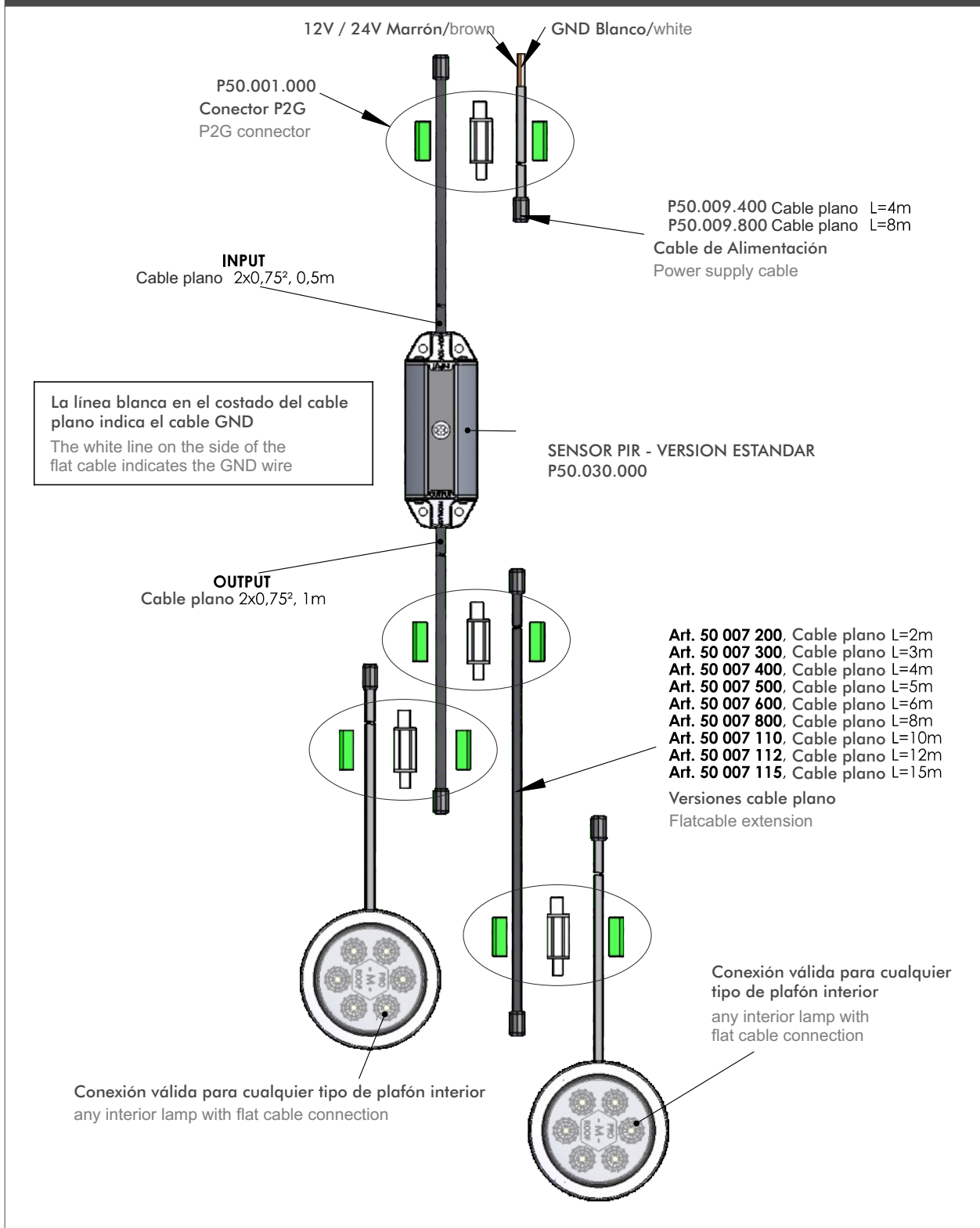

Pilotos Luz Interior LED

LED Interior Lamp

Tipo: Centralita Sensor PIR







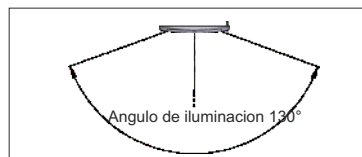

Referencia: Reference-No.	Ud. QTY	Descripción Description	Luz Interior LED LED Interior lamps	Tecnología LED LED Technology
P50.030.000	1	Centralita Sensor-PIR, Cable plano 2 x 0,75mm ² : - Entrada 0,5m - Salida 1,0m Conexión de lámparas hasta 5A 10-28V, IP6K9K Central PIR-Sensor, Flatcable 2 x 0,75mm ² : - Input 0,5m - Output 1,0m connection of lamps up to 5 A, 10-28V, IP6K9K		
P50.007.200	1	Extensión cable plano, 2m 2x0,75mm ² Flat cable extension 2m 2x0,75mm ²		Extensión de cable para una única función, ambos extremos con tapa.
P50.007.400	1	Extensión cable plano, 4m 2x0,75mm ² Flat cable extension 4m 2x0,75mm ²		Mas detalles en la página 9.6.0 extension for single function lamps both sides with end caps
P50.007.600	1	Extensión cable plano, 6m 2x0,75mm ² Flat cable extension 6m 2x0,75mm ²		for further cable lengths, please refer to page 9.6
P50.007.800	1	Extensión cable plano, 8m 2x0,75mm ² Flat cable extension 2m 2x0,75mm ²		Extensión de cable para una única función, ambos extremos con tapa.
P50.007.112	1	Extensión cable plano, 12m 2x0,75mm ² Flat cable extension 4m 2x0,75mm ²		Mas detalles en la página 9.6.0 extension for single function lamps both sides with end caps
P50.007.115	1	Extensión cable plano, 15m 2x0,75mm ² Flat cable extension 6m 2x0,75mm ²		for further cable lengths, please refer to page 9.6
P50.009.400	1	Cable alimentación del Sensor PIR,cable plano, 4m 2x0,75mm ² Flat cable extension 2m 2x0,75mm ²		Un extremo con tapa y el otro extremo con puntas abiertas
P50.009.800	1	Cable alimentación del Sensor PIR,cable plano, 8m 2x0,75mm ² Flat cable extension 2m 2x0,75mm ²		one side with end cap, other side open end
P50.001.000	10	Conector eléctrico para P2G La conexión de 2 cables planos P2G connector for flatcable 2x0,75		

Pilotos Luz Interior LED

LED Interior Lamp

Tipo: PRO-STRIPE
Con Sensor de Movimiento

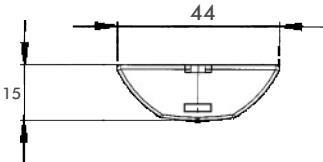

Referencia: Reference-No.	Ud. QTY	Descripción Description	Luz Interior LED LED Interior lamps
P40.048.603 24V	1	<p>Piloto interior LED PRO-STRIPE 1ft. (305mm), 18 LEDs alta potencia, carcasa exterior de aluminio, con cable 0,3m, versión superficie, 24V/2,2W, IP6K9K, ADR</p> <p>LED Interior Lamp PRO-STRIPE, 1ft. (305mm), 18 Power LED's, aluminium housing with cable 0,3m, pendant version, 24V/2,2W</p>	
P40.048.613 24V	1	<p>Piloto interior LED PRO-STRIPE 2ft. (610mm), 48 LEDs alta potencia, carcasa exterior de aluminio, con cable 0,3m, versión superficie, 24V/5,5W, IP6K9K, ADR</p> <p>LED Interior Lamp PRO-STRIPE, 2ft. (610mm), 48 Power LED's, aluminium housing with cable 0,3m, pendant version, 24V/5,5W</p>	<p>170lm PRO-STRIPE 1ft. 305mm</p> 
P40.048.623 24V	1	<p>Piloto interior LED PRO-STRIPE 3ft. (915mm), 78 LEDs alta potencia, carcasa exterior de aluminio, con cable 0,3m, versión superficie, 24V/9W, IP6K9K, ADR</p> <p>LED Interior Lamp PRO-STRIPE, 3ft. (915mm), 78 Power LED's, aluminium housing with cable 0,3m, pendant version, 24V/9W</p>	<p>450lm PRO-STRIPE 2ft. 610mm</p> 
P40.048.723 12V	1	<p>Luz interior LED PRO-STRIPE, 12V/9W</p> <p>LED Interior Lamp PRO-STRIPE, 12V</p>	 <p>Sensor de Movimiento/motion sensor</p>
P40.048.733 12V	1	<p>Piloto interior LED PRO-STRIPE 4ft. (1220mm), 108 LEDs alta potencia, carcasa exterior de aluminio, con cable 0,3m, versión superficie, 12V/12W, IP6K9K, ADR</p> <p>LED Interior Lamp PRO-STRIPE, 4ft. (1220mm), 108 Power LED's, aluminium housing with cable 0,3m, pendant version, 12V/12W</p>	<p>740lm PRO-STRIPE 3ft. 915mm</p>  <p>1030lm PRO-STRIPE 4ft. 1220mm</p> 

Pilotos Luz Interior LED

LED Interior Lamp

Tipo: PRO-TWIN-STRIPE

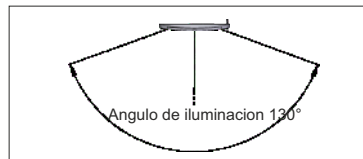

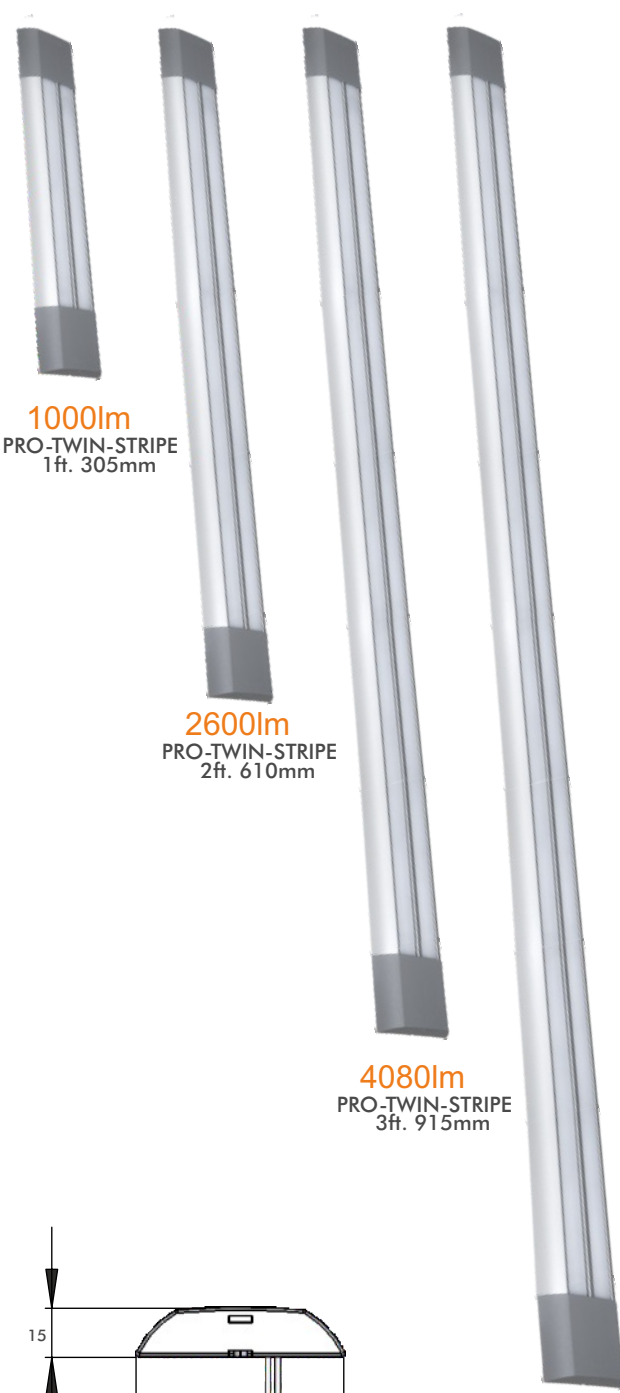
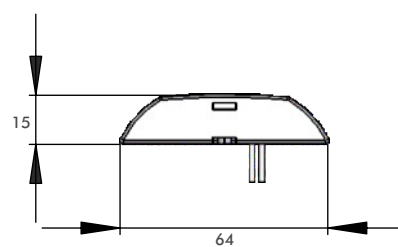

Referencia: Reference-No.	Ud. QTY	Descripción Description	Luz Interior LED LED Interior lamps
P40.064.003 24V	1	<p>Plafón LED PRO-TWIN-STRIPE 1ft. (305mm), 36 LEDs alta potencia, carcasa exterior de aluminio, con cable 0,3m, versión superficie, 24V, IP6K9K, ADR</p> <p>LED Interior Lamp PRO-TWIN-STRIPE, 1ft. (305mm), 36 Power LED's, aluminium housing with cable 0,3m, pendant version, 24V</p>	 <p>1000lm PRO-TWIN-STRIPE 1ft. 305mm</p> <p>2600lm PRO-TWIN-STRIPE 2ft. 610mm</p> <p>4080lm PRO-TWIN-STRIPE 3ft. 915mm</p> <p>6600lm PRO-TWIN-STRIPE 14ft. 220mm</p>
P40.064.203 12V	1	<p>Plafón LED PRO-TWIN-STRIPE, 12V</p> <p>LED Interior Lamp PRO-TWIN-STRIPE, 12V</p>	
P40.064.013 24V	1	<p>Plafón LED PRO-TWIN-STRIPE 2ft. (610mm), 96 LEDs alta potencia, carcasa exterior de aluminio, con cable 0,3m, versión superficie, 24V, IP6K9K, ADR</p> <p>LED Interior Lamp PRO-TWIN-STRIPE, 2ft. (610mm), 96 Power LED's, aluminium housing with cable 0,3m, pendant version, 24V</p>	
P40.064.213 12V	1	<p>Plafón LED PRO-TWIN-STRIPE, 12V</p> <p>LED Interior Lamp PRO-TWIN-STRIPE, 12V</p>	
P40.064.023 24V	1	<p>Plafón LED PRO-TWIN-STRIPE 3ft. (910mm), 156 LEDs alta potencia, carcasa exterior de aluminio, con cable 0,3m, versión superficie, 24V, IP6K9K, ADR</p> <p>LED Interior Lamp PRO-TWIN-STRIPE, 3ft. (915mm), 156 Power LED's, aluminium housing with cable 0,3m, pendant version, 24V</p>	
P40.064.223 12V	1	<p>Plafón LED PRO-TWIN-STRIPE, 12V</p> <p>LED Interior Lamp PRO-TWIN-STRIPE, 12V</p>	
P40.064.033 24V	1	<p>Plafón LED PRO-TWIN-STRIPE 4ft. (1220mm), 192 LEDs alta potencia, carcasa exterior de aluminio, con cable 0,3m, versión superficie, 24V, IP6K9K, ADR</p> <p>LED Interior Lamp PRO-TWIN-STRIPE, 4ft. (1220mm), 192 Power LED's, aluminium housing with cable 0,3m, pendant version, 24V</p>	
P40.064.233 12V	1	<p>Plafón LED PRO-TWIN-STRIPE, 12V</p> <p>LED Interior Lamp PRO-TWIN-STRIPE, 12V</p>	

Pilotos Luz Interior LED

LED Interior Lamp

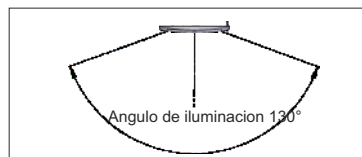
Tipo: PRO-STRIPE
Con Interruptor



Referencia: Reference-No.	Ud. QTY	Descripción Description	Luz Interior LED LED Interior lamps
P40.048.043 24V	1	<p>Piloto interior LED PRO-STRIPE 1ft. (305mm), 18 LEDs alta potencia, carcasa exterior de aluminio, con cable 0,3m, versión superficie, 24V/2,2W, IP6K9K, ADR</p> <p>LED Interior Lamp PRO-STRIPE, 1ft. (305mm), 18 Power LED's, aluminium housing with cable 0,3m, pendant version, 24V/2,2W</p>	 <p>500lm PRO-STRIPE 1ft. 305mm</p> <p>1300lm PRO-STRIPE 2ft. 610mm</p> <p>2040lm PRO-STRIPE 3ft. 915mm</p> <p>3300lm PRO-STRIPE 4ft. 1220mm</p>
P40.048.243 12V	1	<p>Luz interior LED PRO-STRIPE, 12V/2,2W</p> <p>LED Interior Lamp PRO-STRIPE,</p>	
P40.048.053 24V	1	<p>Piloto interior LED PRO-STRIPE 2ft. (610mm), 48 LEDs alta potencia, carcasa exterior de aluminio, con cable 0,3m, versión superficie, 24V/5,5W, IP6K9K, ADR</p> <p>LED Interior Lamp PRO-STRIPE, 2ft. (610mm), 48 Power LED's, aluminium housing with cable 0,3m, pendant version, 24V/5,5W</p>	
P40.048.253 12V	1	<p>Luz interior LED PRO-STRIPE, 12V/5,5W</p> <p>LED Interior Lamp PRO-STRIPE,</p>	
P40.048.063 24V	1	<p>Piloto interior LED PRO-STRIPE 3ft. (915mm), 78 LEDs alta potencia, carcasa exterior de aluminio, con cable 0,3m, versión superficie, 24V/9W, IP6K9K, ADR</p> <p>LED Interior Lamp PRO-STRIPE, 3ft. (915mm), 78 Power LED's, aluminium housing with cable 0,3m, pendant version, 24V/9W</p>	
P40.048.263 12V	1	<p>Luz interior LED PRO-STRIPE, 12V/9W</p> <p>LED Interior Lamp PRO-STRIPE,</p>	
P40.048.073 24V	1	<p>Piloto interior LED PRO-STRIPE 4ft. (1220mm), 108 LEDs alta potencia, carcasa exterior de aluminio, con cable 0,3m, versión superficie, 24V/12W, IP6K9K, ADR</p> <p>LED Interior Lamp PRO-STRIPE, 4ft. (1220mm), 108 Power LED's, aluminium housing with cable 0,3m, pendant version, 24V/12W</p>	
P40.048.273 12V	1	<p>Luz interior LED PRO-STRIPE, 12V/12W</p> <p>LED Interior Lamp PRO-STRIPE,</p>	



Interruptor/on-off switch

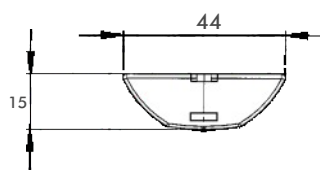

Pilotos Luz Interior LED

LED Interior Lamp

Tipo: PRO-TWIN-STRIPE ECO

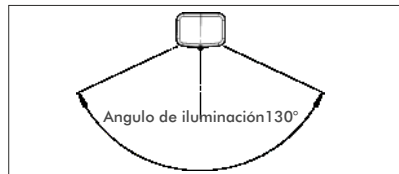

Referencia: Reference-No.	Ud. QTY	Descripción Description	Luz Interior LED con adhesivo posterior LED Interior Lamps with adhesive pad
P40.064.083 24V	1	<p>Plafón LED PRO-TWIN-STRIPE ECO 308mm 1ft., 36 LEDs alta potencia, carcasa exterior de aluminio, con cable 0,3m, versión superficie, 24V, ADR, IP6K9K</p> <p>LED In. Lamp PRO-TWIN-STRIPE ECO 308mm, 36 Power LED's, aluminium housing with cable 0,3m, pendant version, 24V</p>	 <p>1000lm PRO-TWIN-STRIPE ECO 1ft. 308mm</p> <p>2600lm PRO-TWIN-STRIPE ECO 2ft. 613mm</p> <p>4080lm PRO-TWIN-STRIPE ECO 3ft. 918mm</p> <p>6600lm PRO-TWIN-STRIPE ECO 4ft. 1223mm</p>
P40.064.283 12V	1	<p>Plafón LED PRO-TWIN-STRIPE ECO 12V</p> <p>LED In. Lamp PRO-TWIN-STRIPE ECO 12V</p>	
P40.064.093 24V	1	<p>Plafón LED PRO-TWIN-STRIPE ECO 613mm 2ft., 96 LEDs alta potencia, carcasa exterior de aluminio, con cable 0,3m, versión superficie, 24V, ADR, IP6K9K</p> <p>LED In. Lamp PRO-TWIN-STRIPE ECO 613mm, 96 Power LED's, aluminium housing with cable 0,3m, pendant version, 24V</p>	
P40.064.293 12V	1	<p>Plafón LED PRO-TWIN-STRIPE ECO 12V</p> <p>LED In. Lamp PRO-TWIN-STRIPE ECO 12V</p>	
P40.064.323 24V	1	<p>Plafón LED PRO-TWIN-STRIPE ECO 918mm 3ft., 156 LEDs alta potencia, carcasa exterior de aluminio, con cable 0,3m, versión superficie, 24V, ADR, IP6K9K</p> <p>LED In. Lamp PRO-TWIN-STRIPE ECO 918mm, 156 Power LED's, aluminium housing with cable 0,3m, pendant version, 24V</p>	
P40.064.423 12V	1	<p>Plafón LED PRO-TWIN-STRIPE ECO 12V</p> <p>LED In. Lamp PRO-TWIN-STRIPE ECO 12V</p>	
P40.064.333 24V	1	<p>Plafón LED PRO-TWIN-STRIPE ECO 1223mm 4ft., 192 LEDs alta potencia, carcasa exterior de aluminio, con cable 0,3m, versión superficie, 24V, ADR, IP6K9K</p> <p>LED In. Lamp PRO-TWIN-STRIPE ECO 1223mm, 192 Power LED's, aluminium housing with cable 0,3m, pendant version, 24V</p>	
P40.064.433 12V	1	<p>Plafón LED PRO-TWIN-STRIPE ECO 12V</p> <p>LED In. Lamp PRO-TWIN-STRIPE ECO 12V</p>	

Pilotos Luz Interior LED

LED Interior Lamp

Tipo: PRO-STRIPE



Referencia: Reference-No.	Ud. QTY	Descripción Description	Luz Interior LED LED Interior lamps
P40.048.003 24V	1	Piloto interior LED PRO-STRIPE 1ft. (305mm), 18 LEDs alta potencia, carcasa exterior de aluminio, con cable 0,3m, versión superficie, 24V/2,2W, IP6K9K, ADR LED Interior Lamp PRO-STRIPE , 1ft. (305mm), 18 Power LED's, aluminium housing with cable 0,3m, pendant version, 24V/2,2W	<p>500lm PRO-STRIPE 1ft. 305mm</p> <p>1300lm PRO-STRIPE 2ft. 610mm</p> <p>2040lm PRO-STRIPE 3ft. 915mm</p> <p>3300lm PRO-STRIPE 4ft. 1220mm</p>
P40.048.203 12V	1	Luz interior LED PRO-STRIPE , 12V/2,2W LED Interior Lamp PRO-STRIPE , 12V	
P40.048.013 24V	1	Piloto interior LED PRO-STRIPE 2ft. (610mm), 48 LEDs alta potencia, carcasa exterior de aluminio, con cable 0,3m, versión superficie, 24V/5,5W, IP6K9K, ADR LED Interior Lamp PRO-STRIPE , 2ft. (610mm), 48 Power LED's, aluminium housing with cable 0,3m, pendant version, 24V/5,5W	
P40.048.213 12V	1	Luz interior LED PRO-STRIPE , 12V/5,5W LED Interior Lamp PRO-STRIPE , 12V	
P40.048.023 24V	1	Piloto interior LED PRO-STRIPE 3ft. (915mm), 78 LEDs alta potencia, carcasa exterior de aluminio, con cable 0,3m, versión superficie, 24V/9W, IP6K9K, ADR LED Interior Lamp PRO-STRIPE , 3ft. (915mm), 78 Power LED's, aluminium housing with cable 0,3m, pendant version, 24V/9W	
P40.048.223 12V	1	Luz interior LED PRO-STRIPE , 12V/9W LED Interior Lamp PRO-STRIPE , 12V	
P40.048.033 24V	1	Piloto interior LED PRO-STRIPE 4ft. (1220mm), 108 LEDs alta potencia, carcasa exterior de aluminio, con cable 0,3m, versión superficie, 24V/12W, IP6K9K, ADR LED Interior Lamp PRO-STRIPE , 4ft. (1220mm), 108 Power LED's, aluminium housing with cable 0,3m, pendant version, 24V/12W	
P40.048.233 12V	1	Luz interior LED PRO-STRIPE , 12V/12W LED Interior Lamp PRO-STRIPE , 12V	

Pilotos Luz Interior LED

LED Interior Lamp

Tipo: PRO-STRIPE ECO

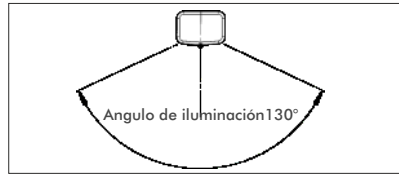

Referencia: Reference-No.	Ud. QTY	Descripción Description	Luz Interior LED con adhesivo posterior LED Interior Lamps with adhesive pad
P40.048.083 24V	1	Piloto interior LED PRO-STRIPE ECO 1, 222mm, 18 LEDs alta potencia, carcasa exterior de aluminio, con cable 0,3m, versión superficie, 24V/2,2W, ADR, IP6K9K LED Interior Lamp PRO-STRIPE ECO 1, 222mm, 18 Power LED's, aluminium housing with cable 0,3m, pendant version, 24V/2,2W	<p>500lm PRO-STRIPE ECO 1 222mm</p> <p>1300lm PRO-STRIPE ECO 2 527mm</p> <p>2040lm PRO-STRIPE ECO 3 832mm</p> <p>3300lm PRO-STRIPE ECO 4 1137mm</p>
P40.048.283 12V	1	Luz interior LED PRO-STRIPE ECO 1, 12V/2,2W LED Interior Lamp PRO-STRIPE ECO 1, 12V	
P40.048.093 24V	1	Piloto interior LED PRO-STRIPE ECO 2, 527mm, 18 LEDs alta potencia, carcasa exterior de aluminio, con cable 0,3m, versión superficie, 24V/5,5W, ADR, IP6K9K LED Interior Lamp PRO-STRIPE ECO 2, 527mm, 48 Power LED's, aluminium housing with cable 0,3m, pendant version, 24V/5,5W	
P40.048.293 12V	1	Luz interior LED PRO-STRIPE ECO 2, 12V/5,5W LED Interior Lamp PRO-STRIPE ECO 2, 12V	
P40.048.323 24V	1	Piloto interior LED PRO-STRIPE ECO 3, 832mm, 18 LEDs alta potencia, carcasa exterior de aluminio, con cable 0,3m, versión superficie, 24V/9W, ADR, IP6K9K LED Interior Lamp PRO-STRIPE ECO 3, 832mm, 78 Power LED's, aluminium housing with cable 0,3m, pendant version, 24V/9W	
P40.048.423 12V	1	Luz interior LED PRO-STRIPE ECO 3, 12V/9W LED Interior Lamp PRO-STRIPE ECO 3, 12V	
P40.048.333 24V	1	Piloto interior LED PRO-STRIPE ECO 4, 1137, 18 LEDs alta potencia, carcasa exterior de aluminio, con cable 0,3m, versión superficie, 24V/12W, ADR, IP6K9K LED Interior Lamp PRO-STRIPE ECO 3, 1137mm, 108 Power LED's, aluminium housing with cable 0,3m, pendant version, 24V/12W	
P40.048.433 12V	1	Luz interior LED PRO-STRIPE ECO 4, 12V/12W LED Interior Lamp PRO-STRIPE ECO 3, 12V	
P40.048.000	1	Kit soportes PRO-STRIPE ECO, incluye tornillos	<p>P40.048.000</p>
P40.048.100	1	Mounting Kit PRO-STRIPE ECO, incl. screws	<p>con salida de cable/with cable outbreaks P40.048.100</p>

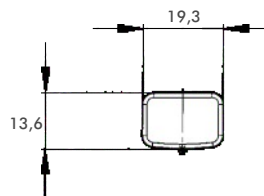



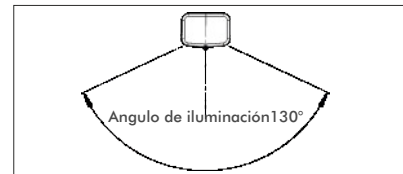

Pilotos Luz Interior LED

LED Interior Lamp

Tipo: PRO-STRIPE ECO
Con Interruptor

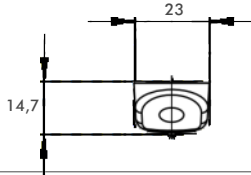

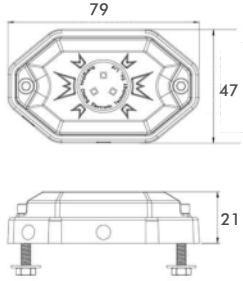
Referencia: Reference-No.	Ud. QTY	Descripción Description	Luz Interior LED con adhesivo posterior LED Interior Lamps with adhesive pad
P40.048.183 24V	1	<p>Piloto interior LED PRO-STRIPE ECO 1, 297mm, 18 LEDs alta potencia, carcasa exterior de aluminio, kit de fijación con adhesivo posterior y kit de montaje con cable 0,3m, versión superficie, 24V/2,2W, ADR, IP6K9K</p> <p>LED Interior Lamp PRO-STRIPE ECO 1, 297mm, 18 POWER-LED's, cabel 0,3m, quick fixation with adhesive pad + mounting kit, IP6K9K appr., ADR, 24V/2,2W</p>	 <p>500lm PRO-STRIPE ECO 1 297mm</p>
P40.048.383 12V	1	<p>Luz interior LED PRO-STRIPE ECO 1 12V/2,2W</p> <p>LED Interior Lamp PRO-STRIPE ECO 1, 12V</p>	
P40.048.193 24V	1	<p>Piloto interior LED PRO-STRIPE ECO 2, 602mm, 48 LEDs alta potencia, carcasa exterior de aluminio, kit de fijación con adhesivo posterior y kit de montaje con cable 0,3m, versión superficie, 24V/5,5W, ADR, IP6K9K</p> <p>LED Interior Lamp PRO-STRIPE ECO 1, 602mm, 48 POWER-LED's, cabel 0,3m, quick fixation with adhesive pad + mounting kit,, IP6K9K appr., ADR, 24V/5,5W</p>	 <p>Interruptor/on-off switch</p>  <p>1300lm PRO-STRIPE ECO 2 602mm</p>
P40.048.393 12V	1	<p>Luz interior LED PRO-STRIPE ECO 2 12V/5,5W</p> <p>LED Interior Lamp PRO-STRIPE ECO 2, 12V</p>	
P40.475.003	1	<p>Piloto interior y Faro de trabajo LED PRO-STEP, iluminación blanca Diseño especial, carcasa aluminio, cable 3M, 10/30V, 9W, ECE R10, IP67, 650 LUMEN,</p> <p>LED Interior Lamp PRO-STEP, 3 power LEDs, white illumination, aluminium die cast housing, lamp complete potted, 12/24V, IP67 Connection: cable 3,0m</p>	<p>650lm</p>   

Pilotos Luz Interior LED

LED Interior Lamp

Tipo: PRO-TWIN-WALL

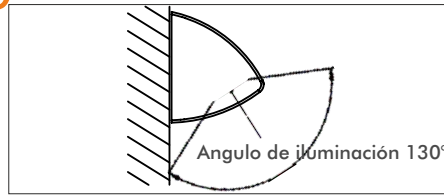



Referencia: Reference-No.	Ud. QTY	Descripción Description	Luz LED para Interior y Exterior LED Lamps for Outdoor and Inner area
P40.066.003 24V	1	Piloto LED PRO-TWIN-WALL 1, 276mm, 36 LEDs alta potencia, carcasa exterior de aluminio, con cable 0,3m, versión superficie, 24V, ADR, IP6K9K LED Lamp PRO-TWIN-WALL 1, 276mm, 36 Power LED's, aluminium housing with cable 0,3m, pendant version, 24V	<p>1000lm PRO-TWIN-WALL 1 276mm</p> <p>2600lm PRO-TWIN-WALL 2 581mm</p> <p>4080lm PRO-TWIN-WALL 3 886mm</p> <p>6600lm PRO-TWIN-WALL 4 1191mm</p>
P40.066.203 12V	1	Piloto LED PRO-TWIN-WALL 1, 12V LED Lamp PRO-TWIN-WALL 1, 12V	
P40.066.013 24V	1	Piloto LED PRO-TWIN-WALL 2, 581mm, 96 LEDs alta potencia, carcasa exterior de aluminio, con cable 0,3m, versión superficie, 24V, ADR, IP6K9K LED Lamp PRO-TWIN-WALL 2, 581mm, 96 Power LED's, aluminium housing with cable 0,3m, pendant version, 24V	
P40.066.213 12V	1	Piloto LED PRO-TWIN-WALL 2, 12V LED Lamp PRO-TWIN-WALL 2, 12V	
P40.066.023 24V	1	Piloto LED PRO-TWIN-WALL 3, 886mm, 156 LEDs alta potencia, carcasa exterior de aluminio, con cable 0,3m, versión superficie, 24V, ADR, IP6K9K LED Lamp PRO-TWIN-WALL 3, 878mm, 156 Power LED's, aluminium housing with cable 0,3m, pendant version, 24V	
P40.066.223 12V	1	Piloto LED PRO-TWIN-WALL 3, 12V LED Lamp PRO-TWIN-WALL 3, 12V	
P40.066.033 24V	1	Piloto LED PRO-TWIN-WALL 4, 1191mm, 192 LEDs alta potencia, carcasa exterior de aluminio, con cable 0,3m, versión superficie, 24V, ADR, IP6K9K LED Lamp PRO-TWIN-WALL 4, 1191mm, 192 Power LED's, aluminium housing with cable 0,3m, pendant version, 24V	
P40.066.233 12V	1	Piloto LED PRO-TWIN-WALL 4, 12V LED Lamp PRO-TWIN-WALL 4, 12V	

Pilotos Luz Interior LED

LED Interior Lamp

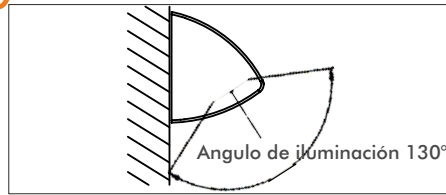
Tipo: PRO-WALL

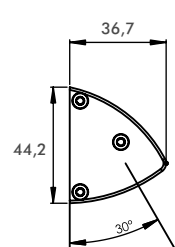

Referencia: Reference-No.	Ud. QTY	Descripción Description	Luz LED para Interior y Exterior LED Lamps for Outdoor and Inner area
P40.060.003 24V	1	Piloto interior LED PRO-WALL 1 , 268mm, 18 LEDs alta potencia, carcasa exterior de aluminio, con cable 0,3m, versión superficie, 24V/2,2W, ADR, IP6K9K LED Lamp PRO-WALL 1 , 268mm, 18 Power LED's, aluminium housing with cable 0,3m, pendant version, 24V/2,2W	 <p>500lm PRO-WALL 1 268mm</p> <p>1300lm PRO-WALL 2 573mm</p> <p>2040lm PRO-WALL 3 878mm</p> <p>3300lm PRO-WALL 4 1183mm</p>
P40.060.203 12V	1	Piloto LED PRO-WALL 1 , 12V/2,2W LED Lamp PRO-WALL 1 , 12V	
P40.060.013 24V	1	Piloto interior LED PRO-WALL 2 , 573mm, 48 LEDs alta potencia, carcasa exterior de aluminio, con cable 0,3m, versión superficie, 24V/5,5W, ADR, IP6K9K LED Lamp PRO-WALL 2 , 573mm, 48 Power LED's, aluminium housing with cable 0,3m, pendant version, 24V/5,5W	
P40.060.213 12V	1	Piloto LED PRO-WALL 2 , 12V/5,5W LED Lamp PRO-WALL 2 , 12V	
P40.060.023 24V	1	Piloto interior LED PRO-WALL 3 , 878mm, 78 LEDs alta potencia, carcasa exterior de aluminio, con cable 0,3m, versión superficie, 24V/9W, ADR, IP6K9K LED Lamp PRO-WALL 3 , 878mm, 78 Power LED's, aluminium housing with cable 0,3m, pendant version, 24V/9W	
P40.060.223 12V	1	Piloto LED PRO-WALL 3 , 12V/9W LED Lamp PRO-WALL 3 , 12V	
P40.060.033 24V	1	Piloto interior LED PRO-WALL 4 , 1183mm, 108 LEDs alta potencia, carcasa exterior de aluminio, con cable 0,3m, versión superficie, 24V/12,5W, ADR, IP6K9K LED Lamp PRO-WALL 4 , 1183mm, 108 Power LED's, aluminium housing with cable 0,3m, pendant version, 24V/12,5W	
P40.060.233 12V	1	Piloto LED PRO-WALL 4 , 12V/12W LED Lamp PRO-WALL 4 , 12V	

Pilotos Luz Interior LED

LED Interior Lamp

Tipo: PRO-WALL
con Interruptor

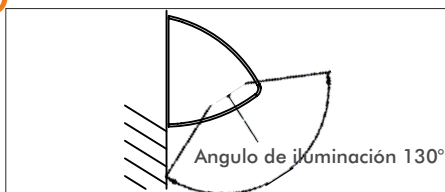

Referencia: Reference-No.	Ud. QTY	Descripción Description	Luz LED para Interior y Exterior con Interruptor LED Lamps for Outdoor and Inner area with switch
P40.060.043 24V	1	Piloto interior LED PRO-WALL 1, 268mm, 18 LEDs alta potencia, carcasa exterior de aluminio, con cable 0,3m, versión superficie, 24V/2,2W, ADR, IP6K9K LED Lamp PRO-WALL 1, 268mm, 18 Power LED's, aluminium housing with cable 0,3m, pendant version, 24V/2,2W	<p>500lm PRO-WALL 1 268mm</p> <p>1300lm PRO-WALL 2 573mm</p> <p>2040lm PRO-WALL 3 878mm</p> <p>3300lm PRO-WALL 4 1183mm</p>
P40.060.243 12V	1	Piloto LED PRO-WALL 1, 12V/2,2W LED Lamp PRO-WALL 1, 12V	
P40.060.053 24V	1	Piloto interior LED PRO-WALL 2, 573mm, 48 LEDs alta potencia, carcasa exterior de aluminio, con cable 0,3m, versión superficie, 24V/5,5W, ADR, IP6K9K LED Lamp PRO-WALL 2, 573mm, 48 Power LED's, aluminium housing with cable 0,3m, pendant version, 24V/5,5W	
P40.060.253 12V	1	Piloto LED PRO-WALL 2, 12V/5,5W LED Lamp PRO-WALL 2, 12V	
P40.060.063 24V	1	Piloto interior LED PRO-WALL 3, 878mm, 78 LEDs alta potencia, carcasa exterior de aluminio, con cable 0,3m, versión superficie, 24V/9W, ADR, IP6K9K LED Lamp PRO-WALL 3, 878mm, 78 Power LED's, aluminium housing with cable 0,3m, pendant version, 24V/9W	
P40.060.263 12V	1	Piloto LED PRO-WALL 3, 12V/9W LED Lamp PRO-WALL 3, 12V	
P40.060.073 24V	1	Piloto interior LED PRO-WALL 4, 1183mm, 108 LEDs alta potencia, carcasa exterior de aluminio, con cable 0,3m, versión superficie, 24V/12,5W, ADR, IP6K9K LED Lamp PRO-WALL 4, 1183mm, 108 Power LED's, aluminium housing with cable 0,3m, pendant version, 24V/12,5W	
P40.060.273 12V	1	Piloto LED PRO-WALL 4, 12V/12W LED Lamp PRO-WALL 4, 12V	





Con Interruptor/on-off switch

Pilotos Luz Interior LED

LED Interior Lamps

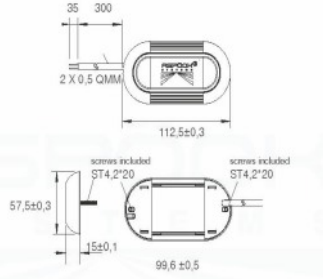
Tipo: INPOINT III

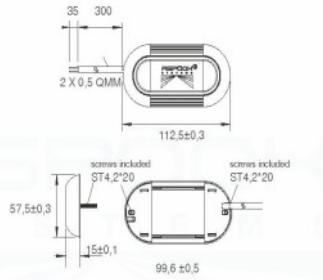

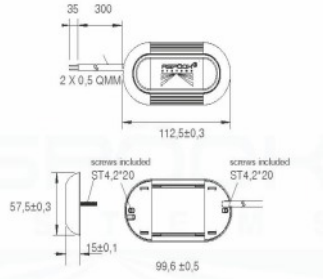

Referencia: Reference-No.	Ud. QTY	Descripción Description	Luz Interior LED LED Interior Lamps	Tecnología LED LED Technology
A39-8900-151	1	<p>Piloto interior LED INPOINT III SHORT, larga vida, bajo consumo, carcasa exterior de aluminio, con cable 0,3m, versión superficie, 12/24V/5W, ADR, IP69K</p> <p>LED interior Lamp INPOINT III SHORT, long life expectancy, very low current consumption aluminium housing with cable 0,3m, pendant version, 12/24V/5W ADR, IP69K</p>	<p>700lm</p>  <p>O.E.: A39-8900-157</p>	
A39-8900-251	1	<p>Piloto interior LED INPOINT III SHORT, larga vida, bajo consumo, carcasa exterior de aluminio, con cable 0,3m, versión superficie, 12/24V/5W, ADR, IP69K</p> <p>LED interior Lamp INPOINT III SHORT, long life expectancy, very low current consumption aluminium housing with cable 0,3m, pendant version, 12/24V/5W ADR, IP69K</p>	 <p>con interruptor</p> <p>O.E.: A39-8900-257</p>	
A39-8900-201	1	<p>Piloto interior LED INPOINT III SHORT, larga vida, bajo consumo, carcasa exterior de aluminio, con cable 0,3m, versión superficie, 12/24V/5W, ADR, IP69K</p> <p>LED interior Lamp INPOINT III SHORT, long life expectancy, very low current consumption aluminium housing with cable 0,3m, pendant version, 12/24V/5W ADR, IP69K</p>	 <p>sensor de movimiento</p> <p>O.E.: A39-8900-207</p>	

Pilotos Luz Interior LED

LED Interior Lamps

Tipo: INPOINT III

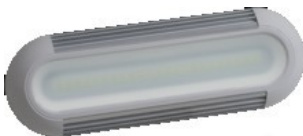
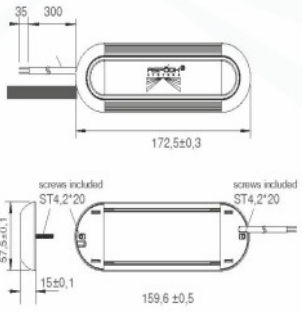

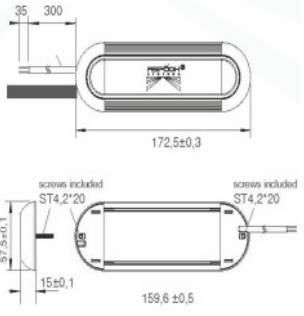
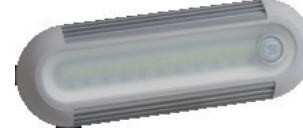
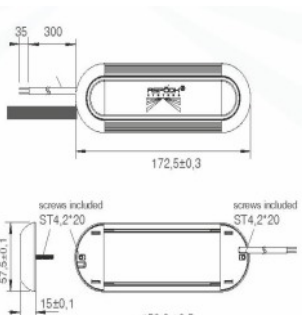



Referencia: Reference-No.	Ud. QTY	Descripción Description	Luz Interior LED LED Interior Lamps	Tecnología LED LED Technology
A39-8900-001	1	<p>Piloto interior LED INPOINT III LONG, larga vida, bajo consumo, carcasa exterior de aluminio, con cable 0,3m, versión superficie, 12/24V/10W, ADR, IP69K</p> <p>LED interior Lamp INPOINT III LONG, long life expectancy, very low current consumption aluminium housing with cable 0,3m, pendant version, 12/24V/10W ADR, IP69K</p>	<p>1400lm</p>  <p>O.E.: A39-8900-007</p>	
A39-8900-101	1	<p>Piloto interior LED INPOINT III LONG, larga vida, bajo consumo, carcasa exterior de aluminio, con cable 0,3m, versión superficie, 12/24V/10W, ADR, IP69K</p> <p>LED interior Lamp INPOINT III LONG, long life expectancy, very low current consumption aluminium housing with cable 0,3m, pendant version, 12/24V/10W ADR, IP69K</p>	<p>1400lm</p>  <p>con interruptor</p> <p>O.E.: A39-8900-107</p>	
A39-8900-051	1	<p>Piloto interior LED INPOINT III LONG, larga vida, bajo consumo, carcasa exterior de aluminio, con cable 0,3m, versión superficie, 12/24V/10W, ADR, IP69K</p> <p>LED interior Lamp INPOINT III LONG, long life expectancy, very low current consumption aluminium housing with cable 0,3m, pendant version, 12/24V/10W ADR, IP69K</p>	<p>1400lm</p>  <p>sensor de movimiento</p> <p>O.E.: A39-8900-057</p>	

Pilotos Luz Interior LED

LED Interior Lamps

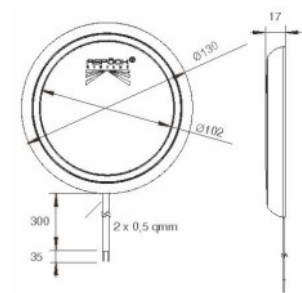

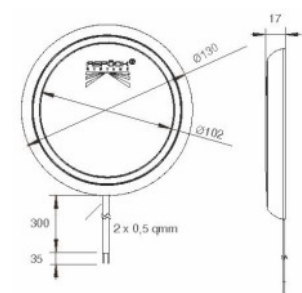

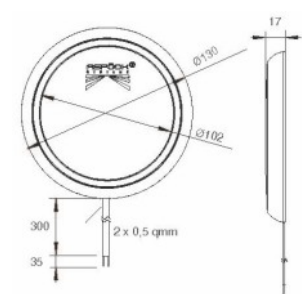
Tipo: INPOINT III

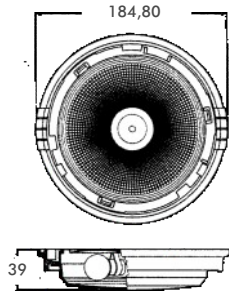

Referencia: Reference-No.	Ud. QTY	Descripción Description	Luz Interior LED LED Interior Lamps	Tecnología LED LED Technology
A39-8900-301	1	<p>Piloto interior LED INPOINT III ROUND, larga vida, bajo consumo, carcasa exterior de aluminio, con cable 0,3m, versión superficie, 12/24V/18W, ADR, IP69K</p> <p>LED interior Lamp INPOINT III ROUND, long life expectancy, very low current consumption aluminium housing with cable 0,3m, pendant version, 12/24V/18W ADR, IP69K</p>	<p>2200lm</p>  <p>O.E.: A39-8900-307</p>	
A39-8900-401	1	<p>Piloto interior LED INPOINT III ROUND, larga vida, bajo consumo, carcasa exterior de aluminio, con cable 0,3m, versión superficie, 12/24V/18W, ADR, IP69K</p> <p>LED interior Lamp INPOINT III ROUND, long life expectancy, very low current consumption aluminium housing with cable 0,3m, pendant version, 12/24V/18W ADR, IP69K</p>	<p>2200lm</p>  <p>con interruptor</p> <p>O.E.: A39-8900-407</p>	
A39-8900-351	1	<p>Piloto interior LED INPOINT III ROUND, larga vida, bajo consumo, carcasa exterior de aluminio, con cable 0,3m, versión superficie, 12/24V/18W, ADR, IP69K</p> <p>LED interior Lamp INPOINT III ROUND, long life expectancy, very low current consumption aluminium housing with cable 0,3m, pendant version, 12/24V/18W ADR, IP69K</p>	<p>2200lm</p>  <p>sensor de movimiento</p> <p>O.E.: A39-8900-357</p>	

Pilotos Luz Interior

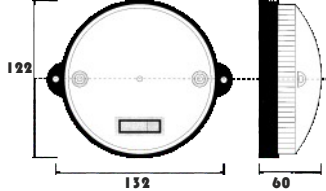
Interior Lamps

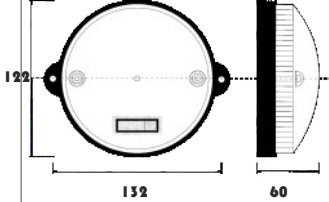
Referencia: Reference-No.	Ud. QTY	Descripción Description	Luz Interior Interior Lamps	BA 15s / P21W
P40.143.003	1	<p>Piloto luz interior con carcasa de plástico y tulipa transparente versión superficie, 12V/24V</p> <p>Interior Lamp, plastic housing, clear lens, pendant version 12V/24V</p>		
A29-8200-007	1	<p>Piloto luz interior con carcasa de plástico y tulipa transparente, con interruptor, versión superficie 12V, incluye bombilla</p> <p>Interior Lamp, plastic housing, clear lens, pendant version 12V</p>		
A29-8200-017	1	<p>Piloto luz interior con carcasa de plástico y tulipa transparente, con interruptor, versión superficie 24V, incluye bombilla</p> <p>Interior Lamp, plastic housing, clear lens, pendant version 24V</p>		

Faro de Trabajo LED	LED Work Lamps	6.0	- 6.15
Faro de Trabajo H3	H3-Work Lamps	6.16	- 6.20
Luz Marcha Atrás LED/	LED Reversing Lamps/	6.21	- 6.22
Luz de Día LED	LED Daytime Running Lights		
Antiniebla-/Auxiliares	Fog-/Spot Lamps	6.23	- 6.25
Faros Conducción	Driving Lamps	6.26	



Faros de Trabajo LED

LED Work Lamps

Tipo: PRO-WORK II 12-36V Doble Alcance
 Tipo: PRO-TWIN-WORK 12/24V Standard Beam



Referencia: Reference-No.	Ud. QTY	Descripción Description	Faros de Trabajo LED LED Work Lamps	Tecnología LED LED Technology
P40.473.503	1	<p>Faro de trabajo LED PRO-WORK II, Para una iluminación amplia y de largo alcance, 8 LEDs de alta intensidad, carcasa compacta, cable 0,5m, 12V-36V, ADR, R10, Potencia de luz: 3500 Lumen</p> <p>LED Work Lamp PRO-WORK II for extreme wide and far-reaching illumination, 8 high intensity LEDs, compact housing, cable 0,5m, 12V-36V, ADR and ECE R10 approved light performance: 3500 Lumen</p>	<p>3500lm</p> 	 <p>Gráfico de Luz/Light Beam</p>
P40.473.003	1	<p>Faro de trabajo LED PRO-WORK II, Para una iluminación amplia y de largo alcance, 6 LEDs de alta intensidad, carcasa compacta, cable 0,5m, 12V-36V, ADR, R10, Potencia de luz: 2500 Lumen</p> <p>LED Work Lamp PRO-WORK II for extreme wide and far-reaching illumination, 6 high intensity LEDs, housing, cable 0,5m, 12V-36V, ADR and ECE R10 approved light performance: 2500 Lumen</p>	<p>2500lm</p> 	 <p>Gráfico de Luz/Light Beam</p>
Pxx.yyy.xxx	1	<p>Faro de Trabajo LED PRO-TWIN-WORK, para iluminación en distancias cortas, 12 Led alta intensidad, carcasa compacta, Cable 0,5m, 12/24V, ADR & ECE R10 Potencia: 1500 Lumen</p> <p>LED Work Lamp PRO-TWIN-WORK for short distance illumination, 12 high intensity LEDs, compact housing, cable 0,5m, 12/24V, ADR and ECE R10 approved light performance: 1500 Lumen</p>	<p>1500lm</p> 	

Faros de Trabajo LED

LED Work Lamp

Tipo: PRO-SECTOR
Sin Reflejos/Glare-free



Referencia: Reference-No.	Ud. QTY	Descripción Description	Pilotos Posición LED LED Position Lamps	Esquema Drawing
P40.484.003	1	<p>Faro de Trabajo LED PRO-SECTOR Luz asimétrica, sin deslumbramiento sin luz dispersa, zona claro-oscuro claramente delimitada Carcasa: Aluminio Tulipa: PC Conexión: 0,5m puntas abiertas Voltaje: 10-30 Volt Protección: IP6K9K Sujección: Soporte tipo U Montaje: Estandar o colgar Homolog.: ADR EMV Consumo: 12V-24,0W / 24V-24,0W 2200 Lumen C. Temper.: 5000-6500K</p> <p><i>LED Work Lamp PRO-SECTOR Asymmetrical illumination No dazzle effect, no scattered light Clear differentiation of the light-dark boundary</i></p> <p>Housing: Aluminium Lens: PC Cable: 0,5m open end Voltage: 10-30 Volt Protection: IP6K9K Fixation: U-bracket Mounting pos.: standing or hanging Homologation: ADR approved EMC approved Power: 12V-24,0W / 24V-24,0W 2200 Lumen Colour Temp.: 5000-6500K</p>	<p>2200lm</p> <p>Sin Reflejo/Glare-free</p>	

Esquema de Iluminación/Illumination scheme

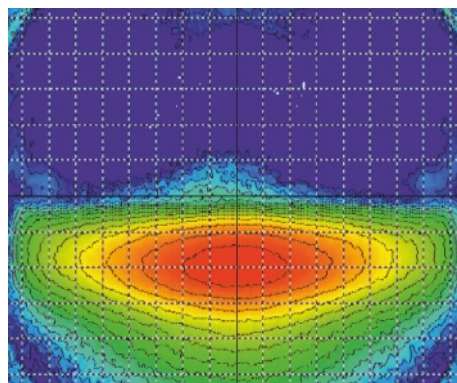

P40.481.003	1	<p>LED Arbeitsscheinwerfer PRO-MINI-MASTER, 4 Osram Power-LED, kompakte Bauform, Aluminium Druckgussgehäuse, wasserdicht vergossen, 12/24V, 40,0W, Deutsch DT Stecker inkl. Adapter mit Kabel 0,5m, ECE R10 & ADR geprüft Lichtleistung: 3600 Lumen</p> <p><i>LED Work Lamp PRO-MINI-MASTER, 4 Osram power LED, compact housing, aluminium die cast housing, lamp complete potted, 12/24V, 40,0W, Deutsch DT con. incl. adapter with cable 0,4m, ECE R10 & ADR approved light performance: 3600 Lumen</i></p>	<p>3600lm</p> <p>DEUTSCH DT</p>	
-------------	---	--	--	--

Faros de Trabajo LED

LED Work Lamps

Tipo: PRO-WORK II 12-36V Luz Estándar



Referencia: Reference-No.	Ud. QTY	Descripción Description	Faros de Trabajo LED LED Work Lamps	Tecnología LED LED Technology
P40.472.503	1	<p>Faro de trabajo LED PRO-WORK II, Para una iluminación amplia, 8 LEDs de alta intensidad, carcasa compacta, cable 0,5m, 12V-36V, ADR, R10, Potencia de luz: 3500 Lumen</p> <p>LED Work Lamp PRO-WORK II for extreme wide illumination, 8 high intensity LEDs, compact housing, cable 0,5m, 12V-36V, ADR and ECE R10 approved light performance: 3500 Lumen</p>	<p>3500lm</p>	<p>Gráfico de Luz/Light Beam</p>
P40.472.003	1	<p>Faro de trabajo LED PRO-WORK II, Para una iluminación amplia, 8 LEDs de alta intensidad, carcasa compacta, cable 0,5m, 12V-36V, ADR, R10, Potencia de luz: 2500 Lumen</p> <p>LED Work Lamp PRO-WORK II for extreme wide illumination, 6 high intensity LEDs, housing, cable 0,5m, 12V-36V, ADR and ECE R10 approved light performance: 2500 Lumen</p>	<p>2500lm</p>	<p>Gráfico de Luz/Light Beam</p>

Faros de Trabajo LED

LED Work Lamps

Tipo: PRO-WORK II H&S 12-36V Luz Estándar



Referencia: Reference-No.	Ud. QTY	Descripción Description	Faros de Trabajo LED LED Work Lamps	Tecnología LED LED Technology
P40.472.303	1	<p>Faro de trabajo LED PRO-WORK II H&S, iluminación uniforme y de largo alcance, 8 LEDs de alta intensidad, carcasa compacta, interruptor y asa, cable 0,5m, 12V-36V, ADR, R10, Potencia de luz: 3500 Lumen</p> <p>LED Work Lamp PRO-WORK II H&S for extreme wide illumination, 8 high intensity LEDs, Handle & Switch, U-bracket, compact housing, cable 0,5m, 12V-36V, ADR and ECE R10 approved light performance: 3500 Lumen</p>	<p>3500lm</p>  <p>Soporte fijación tipo U</p>	  <p>Gráfico de Luz/Light Beam</p>
P40.472.403	1	<p>Faro de trabajo LED PRO-WORK II H&S, iluminación uniforme y de largo alcance, 8 LEDs de alta intensidad, carcasa compacta, interruptor y asa, cable espiral extensible 3m y conector DEUTSCH DT, fijación magnética, 12V-36V, ADR, R10, Potencia de luz: 3500 Lumen</p> <p>LED Work Lamp PRO-WORK II H&S for extreme wide illumination, 8 high intensity LEDs, Handle & Switch, spiral cable with 2-pole DEUTSCH DT connector extends up to 3m, compact housing, Vacuum/Magnetic, 12V-36V, ADR and ECE R10 approved light performance: 3500 Lumen</p>	<p>3500lm</p>  <p>Fijación magnética</p>	  <p>Gráfico de Luz/Light Beam</p>
P50.044.081	1	<p>Cable espiral extensible 7,5m, con conector tipo DEUTSCH DT 2p hembra,</p> <p>Spiral cable with DEUTSCH DT connector 2-pole female, extends up to 7,5m</p>		

Faros de Trabajo LED

LED Work Lamps

Tipo: PRO-SUPER-WORK, PRO-WORK 12V/24V



Referencia: Reference-No.	Ud. QTY	Descripción Description	Faros de Trabajo LED LED Work Lamps	Tecnología LED LED Technology
P40.460.603	1	<p>Faro de trabajo LED PRO-SUPER-WORK, Tecnología FF, iluminación de largo alcance, 6 LEDs, de alta intensidad, carcasa compacta, cable 1,75m, 12V/24V-11W, ADR/ IP67 Potencia de Luz: 1000 Lumen</p> <p>LED Work Lamp PRO-SUPER-WORK in FF-Technology for extreme wide illumination, 6 high intensity wide angle LEDs, compact housing, cable 1,75m, 12V/ 24V-11W, ADR/ IP67 approved light performance: 1000 Lumen</p>	<p>1000lm</p>	<p>Gráfico de Luz/Light Beam</p>
P40.460.003	1	<p>Faro de trabajo LED PRO-SUPER-WORK, Tecnología FF, iluminación amplia y de corto alcance, 6 LEDs, de alta intensidad, carcasa compacta, cable 1,75m, 12V/24V-9W, ADR/ IP67 Potencia de Luz: 500 Lumen</p> <p>LED Work Lamp PRO-SUPER-WORK in FF-Technology for short distance illumination, 6 high intensity wide angle LEDs, compact housing, cable 1,75m, 12V/ 24V-7,9W, ADR/ IP67 approved light performance: 500 Lumen</p>	<p>500lm</p>	<p>Gráfico de Luz/Light Beam</p>

Faros de Trabajo LED

LED Work Lamps

Tipo: PRO-ROCK II 12-80V Luz Estandar



Referencia: Reference-No.	Ud. QTY	Descripción Description	Faros de Trabajo LED LED Work Lamps	Tecnología LED LED Technology
P40.469.003	1	<p>Faro de trabajo LED PRO-ROCK II, para iluminación de largo alcance, 10 LED`s de alta potencia, carcasa robusta de aluminio, cable 0,5m, 12V-80V, 25W, IP6K9K, Potencia de Luz: 2000 Lumen</p> <p>LED Work Lamp PRO-ROCK II for far-reaching illumination, 10 high power LEDs, aluminium die cast housing, cable 0,5m, 12V-80V, 25W, IP6K9K approved, light performance: 2000 lumen</p>	<p>2000lm</p> 	 
P40.469.073	1	<p>Faro de trabajo LED PRO-ROCK II, para iluminación de largo alcance, 10 LED`s de alta potencia, carcasa robusta de aluminio, cable 0,2m y conector AMP SUPER SEAL, 12V-80V, 25W, IP6K9K, Potencia de Luz: 2000 Lumen</p> <p>LED Work Lamp PRO-ROCK II for far-reaching illumination, 10 high power LEDs, aluminium die cast housing, 12V-80V, 25W, IP6K9K approved, cable 0,2m with AMP SUPER SEAL connector light performance: 2000 lumen</p>	<p>2000lm</p>  <p>AMP SUPER SEAL</p>	  <p>Gráfico de Luz/Light Beam</p>
P40.469.083	1	<p>Faro de trabajo LED PRO-ROCK II, para iluminación de largo alcance, 10 LED`s de alta potencia, carcasa robusta de aluminio, cable 0,2m y conector DEUTSCH DT, 12V-80V, 25W, IP6K9K, Potencia de Luz: 2000 Lumen</p> <p>LED Work Lamp PRO-ROCK II for far-reaching illumination, 10 high power LEDs, aluminium die cast housing, 12V-80V, 25W, IP6K9K approved, cable 0,2m with DEUTSCH DT connector light performance: 2000 lumen</p>	<p>2000lm</p>  <p>DEUTSCH DT</p>	

Faros de Trabajo LED

LED Work Lamps

Tipo: PRO-ROCK II 12-80V Luz Amplia



Referencia: Reference-No.	Ud. QTY	Descripción Description	Faros de Trabajo LED LED Work Lamps	Tecnología LED LED Technology
P40.469.013	1	<p>Faro de trabajo LED PRO-ROCK II, para iluminación amplia, 10 LED`s de alta potencia, carcasa robusta de aluminio, cable 0,5m, 12V-80V, 25W, IP6K9K, Potencia de Luz: 2000 Lumen</p> <p>LED Work Lamp PRO-ROCK II for extreme wide illumination, 10 high power LEDs, aluminium die cast housing, cable 0,5m, 12V-80V, 25W, IP6K9K approved, light performance: 2000 lumen</p>	<p>2000lm</p> 	
P40.469.773	1	<p>Faro de trabajo LED PRO-ROCK II, para iluminación amplia, 10 LED`s de alta potencia, carcasa robusta de aluminio, cable 0,2m y conector AMP SUPER SEAL, 12V-80V, 25W, IP6K9K, Potencia de Luz: 2000 Lumen</p> <p>LED Work Lamp PRO-ROCK II for extreme wide illumination, 10 high power LEDs, aluminium die cast housing, 12V-80V, 25W, IP6K9K approved, cable 0,2m with AMP SUPER SEAL connector light performance: 2000 lumen</p>	<p>2000lm</p>  <p>AMP SUPER SEAL</p>	  <p>Gráfico de Luz/Light Beam</p>
P40.469.783	1	<p>Faro de trabajo LED PRO-ROCK II, para iluminación amplia, 10 LED`s de alta potencia, carcasa robusta de aluminio, cable 0,2m y conector DEUTSCH DT, 12V-80V, 25W, IP6K9K, Potencia de Luz: 2000 Lumen</p> <p>LED Work Lamp PRO-ROCK II for extreme wide illumination, 10 high power LEDs, aluminium die cast housing, 12V-80V, 25W, IP6K9K approved, cable 0,2m with DEUTSCH DT connector light performance: 2000 lumen</p>	<p>2000lm</p>  <p>DEUTSCH DT</p>	

Faros de Trabajo LED

LED Work Lamps

Tipo: PRO-ROCK II 12-80V Larga distancia



Referencia: Reference-No.	Ud. QTY	Descripción Description	Faros de Trabajo LED LED Work Lamps	Tecnología LED LED Technology
P40.469.023	1	<p>Faro de trabajo LED PRO-ROCK II, para iluminación de larga distancia, 10 LED`s de alta potencia, carcasa robusta de aluminio, cable 0,5m, 12V-80V, 25W, IP6K9K, Potencia de Luz: 2000 Lumen</p> <p>LED Work Lamp PRO-ROCK II for long distance illumination, 10 high power LEDs, aluminium die cast housing, cable 0,5m, 12V-80V, 25W, IP6K9K approved, light performance: 2000 lumen</p>	<p>2000lm</p> 	 <p>Gráfico de Luz/Light Beam</p>
P40.425.003	1	<p>Faro de trabajo LED PRO-ECO-FIELD, 4 LED`s de alta potencia, carcasa robusta de aluminio, tulipa de policarbonato, 9/32V, 12W, ECE R10 Potencia de Luz: 1100 Lumen</p> <p>LED Work Lamp PRO-ECO-FIELD 4 high power LEDs, aluminium die cast housing, lens made of unbreakable polycarbonate, 9/32V, 12w ECE R10, light performance: 650 lumen</p>	<p>1100lm</p> 	
P40.469.903	1	<p>Faro de trabajo LED PRO-INDU-ROCK, para uso industrial, iluminación homogénea 6 LED`s de alta potencia, carcasa robusta de aluminio, 10/110V, 30W, IP67 Potencia de Luz: 2100 Lumen</p> <p>LED Work Lamp PRO-INDU-ROCK for industrial use, homogeneous illumination, 6 high power LEDs, aluminium die cast housing, cable 0,45m, 10V - 110V, 30W, IP67, light performance: 2100 lumen</p>	<p>2100lm</p> 	

NEW

Faros de Trabajo LED

LED Work Lamps

Tipo: PRO-ROCK II H&S 12-36V Luz Estandar



Referencia: Reference-No.	Ud. QTY	Descripción Description	Faros de Trabajo LED LED Work Lamps	Tecnología LED LED Technology
P40.469.303	1	<p>Faro de trabajo LED PRO-ROCK II H&S, con asa e interruptor, para iluminación de largo alcance, 10 LED`s de alta potencia, carcasa robusta de aluminio, cable 0,5m, fijación en U 12V-36V, 25W, IP6K9K, Potencia de Luz: 2000 Lumen</p> <p>LED Work Lamp PRO-ROCK II H&S for far-reaching illumination, with handle & switch, 10 high power LEDs, aluminium die cast housing, cable 0,5m, 12-36V, 25W, IP6K9K approved, fixation: U-bracket, light performance: 2000 lumen</p>	<p>2000lm</p>  <p>Soporte fijación tipo U</p>	 
P40.469.403	1	<p>Faro de trabajo LED PRO-ROCK II H&S, con asa e interruptor, para iluminación de largo alcance, 10 LED`s de alta potencia, carcasa robusta de aluminio, cable espiral extensible 3m con conector DEUTSCH DT, fijación magnética, 12V-36V, 25W, IP6K9K, Potencia de Luz: 2000 Lumen</p> <p>LED Work Lamp PRO-ROCK II H&S for far-reaching illumination, with handle & switch, 10 high power LEDs, aluminium die cast housing, spiral cable with 2-pole DEUTSCH DT connector extends up to 3m, 12-36V, 25W, IP6K9K approved, fixation: Vacuum/Magnetic, light performance: 2000 lumen</p>	<p>2000lm</p>  <p>Magnético/Magent</p>	  <p>Gráfico de Luz/Light Beam</p>
P50.044.081	1	<p>Cable espiral extensible 7,5m, con conector tipo DEUTSCH DT 2p hembra,</p> <p>Spiral cable with DEUTSCH DT connector 2-pole female, extends up to 7,5m</p>		

Faros de Trabajo LED

LED Work Lamps

Tipo: PRO-POWER-ROCK 12-36V Luz Estandar



Referencia: Reference-No.	Ud. QTY	Descripción Description	Faros de Trabajo LED LED Work Lamps	Tecnología LED LED Technology
P40.467.503	1	<p>Faro de trabajo LED PRO-POWER-ROCK, para iluminación de largo alcance, 6 LED`s de alta potencia carcasa robusta de aluminio, cable 2,0m, 12V-62W, 24V-67W, IP6K9K Potencia de Luz: 4500 Lumen</p> <p>LED Work Lamp PRO-POWER-ROCK for far-reaching illumination, 6 high power LEDs, aluminium die cast housing, cable 2,0m, 12V-62W, 24V-67W, IP6K9K approved, light performance: 4500 lumen</p>	<p>4500lm</p>   	 
P40.467.773	1	<p>Faro de trabajo LED PRO-POWER-ROCK, para iluminación de largo alcance, 6 LED`s de alta potencia, carcasa robusta de aluminio, cable 0,2m con conector AMP SUPER SEAL 12V-62W, 24V-67W, IP6K9K Potencia de Luz: 4500 Lumen</p> <p>LED Work Lamp PRO-POWER-ROCK for far-reaching illumination, 6 high power LEDs, aluminium die cast housing, 12V-62W, 24V-67W, IP6K9K approved, cable 0,2m with AMP SUPER SEAL connector light performance: 4500 lumen</p>	<p>4500lm</p>   <p>AMP SUPER SEAL</p>	  <p>Gráfico de Luz/Light Beam</p>
P40.467.783	1	<p>Faro de trabajo LED PRO-POWER-ROCK, para iluminación de largo alcance, 6 LED`s de alta potencia, carcasa robusta de aluminio, cable 0,2m con conector DEUTSCH DT 12V-62W, 24V-67W, IP6K9K Potencia de Luz: 4500 Lumen</p> <p>LED Work Lamp PRO-POWER-ROCK for far-reaching illumination, 6 high power LEDs, aluminium die cast housing, 12V-62W, 24V-67W, IP6K9K approved, cable 0,2m with DEUTSCH DT connector light performance: 4500 lumen</p>	<p>4500lm</p>   <p>DEUTSCH DT</p>	

Faros de Trabajo LED

LED Work Lamps

Tipo: PRO-POWER-ROCK 12-36V Larga Distancia
 PRO-ROCK-EXTREME 9-32V Luz Estandar
 PRO-SUPER-ROCK 12-36V Luz Estandar



Referencia: Reference-No.	Ud. QTY	Descripción Description	Faros de Trabajo LED LED Work Lamps	Tecnología LED LED Technology
P40.467.523	1	<p>Faro de trabajo LED PRO-POWER-ROCK, para iluminación de larga distancia, 6 LED`s de alta potencia carcasa robusta de aluminio, cable 2,0m, 12V-62W, 24V-67W, IP6K9K Potencia de Luz: 4500 Lumen</p> <p>LED Work Lamp PRO-POWER-ROCK for long distance illumination, 6 high power LEDs, aluminium die cast housing, cable 2,0m, 12V-62W, 24V-67W, IP6K9K approved, light performance: 4500 lumen</p>	<p>4500lm</p>	<p>Gráfico de Luz/Light Beam</p>
P40.426.003	1	<p>Faro de trabajo LED PRO-ROCK EXTREME, para iluminación amplia 20 LED`s de alta intensidad, carcasa robusta de aluminio, tulipa de policarbonato cable 0,45m, 9V-32V/100W, IP6K9K Potencia de Luz: 7000 Lumen</p> <p>LED Work Lamp PRO-ROCK Extreme for extreme wide illumination, 20 high power LEDs, lens are constructed of unbreakable polycarbonate, aluminium die cast housing, cable 0,45m, 12V-32V 100W, IP6K9K approved, light performance: 7000 lumen</p>	<p>7000lm</p>	<p>Lichtverteilungsschema/Light Beam</p>
P40.467.003	1	<p>Faro de trabajo LED PRO-SUPER-ROCK, para iluminación amplia 6 LED`s de alta potencia carcasa robusta de aluminio, cable 2,0m, 12V-53W, 24V-60W, IP6K9K Potencia de Luz: 3000 Lumen</p> <p>LED Work Lamp PRO-SUPER-ROCK for far-reaching illumination, 6 high power LEDs, aluminium die cast housing, cable 2,0m, 12V-53W, 24V-60W, IP6K9K approved, light performance: 3000 lumen</p>	<p>3000lm</p>	<p>Lichtverteilungsschema/Light Beam</p>

Faros de Trabajo LED

LED Work Lamps

Tipo: PRO-MIDI-ROCK 12-36V Luz Estandar

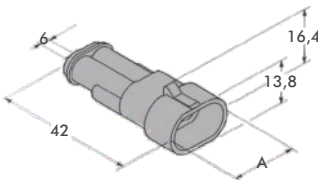

Referencia: Reference-No.	Ud. QTY	Descripción Description	Faros de Trabajo LED LED Work Lamps	Tecnología LED LED Technology
P40.470.003	1	<p>Faro de trabajo LED PRO-MIDI-ROCK, para iluminación amplia, 2 LED`s de alta potencia carcasa robusta de aluminio, cable 0,5m, 12V-36V-20W, IP6K9K Potencia de Luz: 1800 Lumen</p> <p>LED Work Lamp PRO-MIDI-ROCK for short distance illumination, 2 Power LED`s, aluminium die cast housing, cable 0,5m, 12V-36V, 20W, IP6K9K approved, light performance: 1800 lumen</p>	<p>1800lm</p> 	 
P40.470.073	1	<p>Faro de trabajo LED PRO-MIDI-ROCK, para iluminación amplia, 2 LED`s de alta potencia carcasa robusta de aluminio, cable 0,2m, con conector AMP SUPER SEAL 12V-36V-20W, IP6K9K Potencia de Luz: 1800 Lumen</p> <p>LED Work Lamp PRO-MIDI-ROCK for short distance illumination, 2 Power LED`s, aluminium die cast housing, 12V-36V, 20W, IP6K9K approved, cable 0,2m with AMP SUPER SEAL connector light performance: 1800 lumen</p>	<p>1800lm</p>  <p>AMP SUPER SEAL</p>	  <p>Gráfica de Luz/Light Beam</p>
P40.470.083	1	<p>Faro de trabajo LED PRO-MIDI-ROCK, para iluminación amplia, 2 LED`s de alta potencia carcasa robusta de aluminio, cable 0,2m, con conector DEUTSCH DT 12V-36V-20W, IP6K9K Potencia de Luz: 1800 Lumen</p> <p>LED Work Lamp PRO-MIDI-ROCK for short distance illumination, 2 Power LED`s, aluminium die cast housing, 12V-36V, 20W, IP6K9K approved, cable 0,2m with DEUTSCH DT connector light performance: 1800 lumen</p>	<p>1800lm</p>  <p>DEUTSCH DT</p>	

Faros de Trabajo LED

LED Work Lamps

Tipo: PRO-MINI-ROCK 1000 12-36V







Referencia: Reference-No.	Ud. QTY	Descripción Description	Faros de Trabajo LED LED Work Lamps	Tecnología LED LED Technology
P40.468.003	1	<p>Faro de trabajo LED PRO-MINI-ROCK, para corta distancia, 1 LED de alta potencia carcasa robusta de aluminio, cable 0,5m, 12V-36V-11W, IP6K9K Potencia de Luz: 1000 Lumen</p> <p>LED Work Lamp PRO-MINI-ROCK for short distance illumination, 1 high power LED, aluminium die cast housing, cable 0,5m, 12V-36V, 11W, IP6K9K approved, light performance: 1000 lumen</p>	<p>1000lm</p>	
P40.468.073	1	<p>Lfaro de trabajo LED PRO-MINI-ROCK, para corta distancia, 1 LED de alta potencia carcasa robusta de aluminio, cable 0,2m con conector AMP SUPER SEAL 12V-36V-11W, IP6K9K Potencia de Luz: 1000 Lumen</p> <p>LED Work Lamp PRO-MINI-ROCK for short distance illumination, 1 high power LED, aluminium die cast housing, 12V-36V, 11W, IP6K9K approved, cable 0,2m with AMP SUPER SEAL connector light performance: 1000 lumen</p>	<p>1000lm</p> <p>AMP SUPER SEAL</p>	
P40.468.083	1	<p>Lfaro de trabajo LED PRO-MINI-ROCK, para corta distancia, 1 LED de alta potencia carcasa robusta de aluminio, cable 0,2m con conector AMP DEUTSCH DT 12V-36V-11W, IP6K9K Potencia de Luz: 1000 Lumen</p> <p>LED Work Lamp PRO-MINI-ROCK for short distance illumination, 1 high power LED, aluminium die cast housing, 12V-36V, 11W, IP6K9K approved, cable 0,2m with DEUTSCH DT connector light performance: 1000 lumen</p>	<p>1000lm</p> <p>DEUTSCH DT</p>	<p>Gráfico de Luz/Light Beam</p>

Faros de Trabajo LED

LED Work Lamps

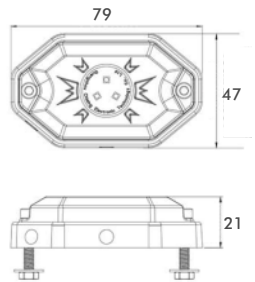
Tipo: PRO-MINI-ROCK 500 12-36V
PRO-STEP
PRO-SUPER-FIELD "H&B"

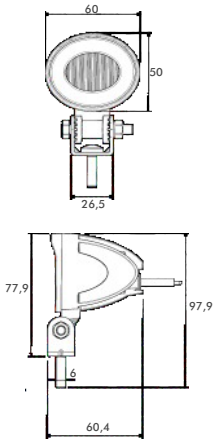

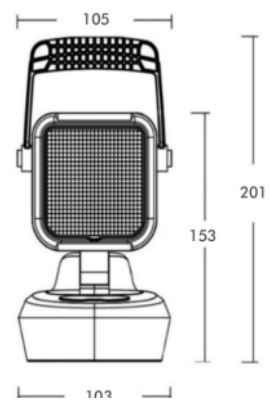
Referencia: Reference-No.	Ud. QTY	Descripción Description	Faros de Trabajo LED LED Work Lamps	Tecnología LED LED Technology
P40.475.003	1	<p>Faro de trabajo y Piloto interior LED PRO-STEP, iluminación blanca. Diseño especial, carcasa aluminio, cable 3M, 10/30V, 9W, ECE R10, IP67, 650 LUMEN,</p> <p>LED Interior Lamp PRO-STEP, 3 power LEDs, white illumination, aluminium die cast housing, lamp complete potted, 12/24V, IP67 Connection: cable 3,0m</p>	<p>650lm</p> 	
P40.468.013	1	<p>Faro de trabajo LED PRO-MINI-ROCK, para corta distancia, 1 LED de alta potencia carcasa robusta de aluminio, cable 0,5m, 12V-36V-6,5W, IP6K9K Potencia de Luz: 500 Lumen</p> <p>LED Work Lamp PRO-MINI-ROCK for short distance illumination, 2 LED's, aluminium die cast housing, cable 0,5m, 12V-36V, 6,5W, IP6K9K approved, light performance: 500 lumen</p>	<p>500lm</p> 	  <p>Gráfico de Luz/Light Beam</p>
P40.429.503	1	<p>Faro de trabajo LED PRO-SUPER-FIELD "H&B" Recargable, tiempo de carga y descarga 4 horas, 650 Lumen, carcasa exterior aluminio, 4 Funciones: Intensidad 100%, Intensidad 50%, Señal SOS, cuadruple flash ámbar, Interruptor encendido/apagado, con cable conector 12/24V, 220V R10, fijación magnética.</p> <p>LED Work Lamp PRO-SUPER-FIELD "H&B" Rechargeable 650L, magnetic, compact profile aluminium, 4 funct: 100% intensity, 50% intensity - SOS Signal - amber quad flash, ON/OFF switch, incl. 12V cigarette plug charger & 220V power supply discharging/charging ca. 4 hours, ECE R10</p>		

Faros de Trabajo y Marcha Atrás LED

LED Work Lamps & Reversing Lamp

Tipo: PRO-SUPER-FIELD 9-32V
 PRO-FIELD 9-32V

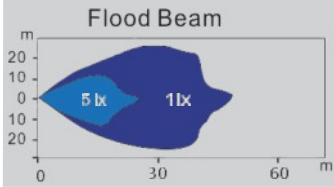

Referencia: Reference-No.	Ud. QTY	Descripción Description	Faros de Trabajo LED LED Work Lamps	Tecnología LED LED Technology
P40.429.003	1	<p>Faro de trabajo LED PRO-SUPER-FIELD, 6 Potentes LED, iluminación homogénea, perfil extremadamente compacto, carcasa de aluminio, tulipa policarbonado, ECE R23, 4 LEDs cable 0,45m, ADR,9V/32V /18W Potencia de luz: 1500Lumen</p> <p>LED Work Lamp PRO-SUPER-FIELD, for far-reaching illumination, 6 high power LEDs, aluminium die cast housing, lens made of unbreakable polycarbonate, cable 0,45m,9-32V, 18W, light performance: 1500 lumen</p>	<p>1500lm</p> 	 
P40.429.073	1	CON CONECTOR AMP SUPER SEAL		
P40.429.083	1	CON CONECTOR DT		
P40.429.303	1	CON INTERRUPTOR		
P40.429.903	1	ESPECIAL VOLTAJE 10/110V		
P40.424.003	1	<p>Faro de trabajo y Luz de marcha atrás LED PRO-FIELD, iluminación homogénea, perfil extremadamente compacto, carcasa de aluminio, tulipa policarbonado, ECE R23, 4 LEDs cable 0,45m, ADR,9V/32V /12W Potencia de luz: 800Lumen</p> <p>LED Reversing-Work Lamp PRO-FIELD, according to ECE R23, useable as Work Lamp, 800 lumen, homogeneous illumination, extreme compact profile, aluminium die cast housing, lens are constructed of unbreakable polycarbonate, cable 0,45m, ADR-appr., ECE R10 appr., 9-32V</p>	<p>800lm</p>  	 

Faros de Trabajo LED

LED Work Lamps



Referencia: Reference-No.	Ud. QTY	Descripción Description	Faros de Trabajo LED LED Work Lamps	Tecnología LED LED Technology
P40.414.003	1	<p>Faro de linea de advertencia LED PRO-FLT, lámpara óptica para la conducción, emisión de luz AZUL, cable 0,45m, 10-94V - 12W</p> <p>LED Warning Lamp PRO-FLT spot beam optical driving path warning lamp, light emission blue, cable 0,45m, 10-94V - 12W</p>		
P40.417.003	1	<p>Faro de linea de advertencia LED, lámpara óptica de para la conducción, emisión de luz AZUL, cable 0.45m, 9-48V - 6W Potencia de luz: 750 Lumen</p> <p>LED Warning Lamp spot beam optical driving path warning lamp, light emission blue, cable 0,45m, 9-48V - 6W</p>		

Faros de Trabajo LED

LED Work Lamps

Tipo: WORKPOINT 12-24V Homologado Marcha Atrás

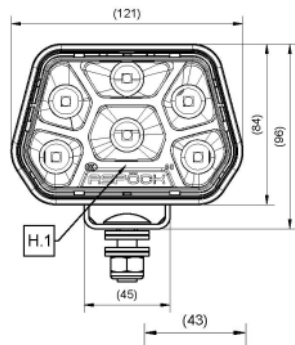
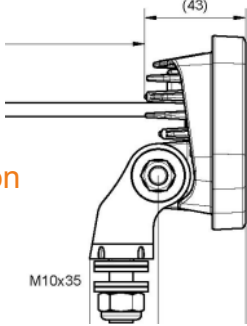
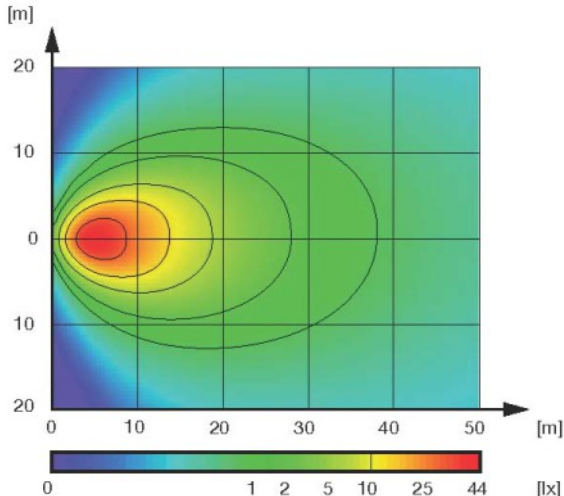
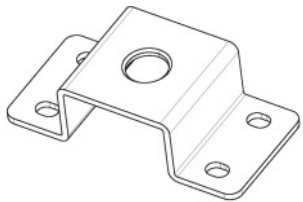
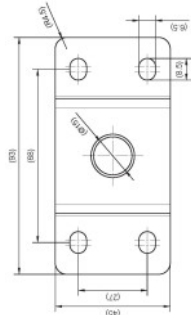

Referencia: Reference-No.	Ud. QTY	Descripción Description	Faros de Trabajo LED LED Work Lamps	Tecnología LED LED Technology
A28-8524-001 O.E.: A28-8524-007	1	<p>Faro de trabajo Led Aspöck WORKPOINT II LED, Marcha Atrás larga duración, 5 LEDs alta potencia de luz, carcasa robusta de aluminio, CONECTOR DT 12V 11,4W, 24V 12W, ADR, IP6K9K, R10 Potencia de Luz: 1500 Lumen</p> <p>LED Work Lamp & reversing lamp WORKPOINT LED long life expectancy, high light output, 5 LED, aluminium cast housing, DT Con., 12V 11,4W, 24V 12W ADR, IP6K9K, R10 light performance: 1500 lumen</p>	<p>1500lm</p> 	
A38-8524-001 O.E.: A38-8524-007	1	<p>Faro de trabajo Led Aspöck WORKPOINT II LED, Marcha Atrás larga duración, 5 LEDs alta potencia de luz, carcasa robusta de aluminio, CABLE 1,5M 12V 11,4W, 24V 12W, ADR, IP6K9K, R10 Potencia de Luz: 1500 Lumen</p> <p>LED Work Lamp & reversing lamp WORKPOINT LED long life expectancy, high light output, 5 LED, aluminium cast housing, cabla 1,5m, 12V 11,4W, 24V 12W ADR, IP6K9K, R10 light performance: 1500 lumen</p>	<p>Marcha Atrás</p> <p>No incluye soporte fijación</p>	
A38-8524-051 O.E.: A38-8524-057	1	<p>Faro de trabajo Led Aspöck WORKPOINT II LED, Marcha Atrás larga duración, 5 LEDs alta potencia de luz, carcasa robusta de aluminio, CABLE 1,5M + CONECTOR ASS2 12V 11,4W, 24V 12W, ADR, IP6K9K, R10 Potencia de Luz: 1500 Lumen</p> <p>LED Work Lamp & reversing lamp WORKPOINT LED long life expectancy, high light output, 5 LED, aluminium cast housing, cabla 1,5m + ASS2 connector 12V 11,4W, 24V 12W ADR, IP6K9K, R10 light performance: 1500 lumen</p>		
A14-4302-227	1	<p>Soporte fijación Faro de trabajo tipo U</p> <p>Fixation Bracket U type for LED work lamp</p>		

Faros de Trabajo LED

LED Work Lamps









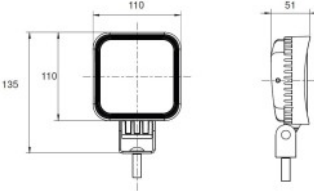

Referencia: Reference-No.	Ud. QTY	Descripción Description	Faros de Trabajo LED LED Work Lamps	Tecnología LED LED Technology
FA42-1000-001 Amplia Ilum.	1	Faro de trabajo Led Fabrilcar, 5 LEDs alta potencia de luz, carcasa robusta de aluminio, cable 1,5m, 10/30V, 15W IP67,R10, EMC, R23 Marcha Atrás. Potencia de Luz: 1200 Lumen LED Work Lamp and reversing lamp high light 5 LED's, aluminium housing, cable 1,5m,10/30V, 15W, Ip67, EMC, R23, light performance: 1200 lumen	1200lm  Marcha Atrás	
FA42-1000-101 Amplia Ilum.	1	Faro de trabajo Led Fabrilcar, 5 LEDs alta potencia de luz, carcasa robusta de aluminio, cable 1,5m, 10/30V, 15W IP67, R10, EMC. Potencia de Luz: 1200 Lumen LED Work Lamp, high light 5 LED's, aluminium housing, cable 1,5m,10/30V, 15W IP67 light performance: 1200 lumen	1200lm 	
FA42-1000-251 Amplia Ilum.	1	Faro de trabajo Led Magnético Fabrilcar, 4 tipos luz: blanco ámbar, 30% ECO, FLASH SOS, batería recargable, duraci6n 4-13 horas, tiempo de carga 3,5 horas Potencia de Luz: 1000 Lumen LED Magnetic Work Lamp, 4 modes: white, amber, 30% ECO, SOS FLASH, Rechargeable Batt., time work 4-13H, recharge time 3,5 light performance: 1000 lumen	1000lm 	
FA42-1000-211 Amplia Ilum.	1	Faro de trabajo Led Magnético Fabrilcar, 3 tipos luz: Alta potencia ECO, FLASH SOS, batería recargable, duraci6n 2-3horas, tiempo de carga 5 horas Potencia de Luz: 1000 Lumen LED Magnetic Work Lamp, 3 modes: high light, ECO, SOS FLASH, Rechargeable Battery, time work 2-3H, recharge time 5H. light performance: 1000 lumen	1000lm  Carcasa plástico	
FA42-1001-001 Amplia Ilum.	1	Faro de trabajo Led Fabrilcar, 9 LEDs alta potencia de luz, carcasa robusta de aluminio, cable 1,5m, 10/30V, 27W IP67,R10, EMC, R23 Marcha Atrás. Potencia de Luz: 2000 Lumen LED Work Lamp and reversing lamp high light 9 LED's, aluminium housing, cable 1,5m,10/30V, 27W, IP67, R23 light performance: 2000 lumen	2000lm  Marcha Atrás	

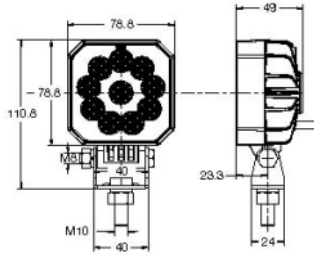
Faros de Trabajo LED

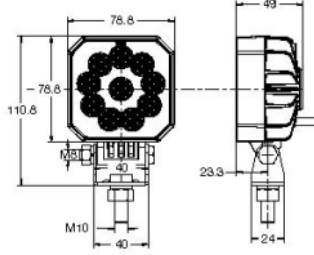
LED Work Lamps

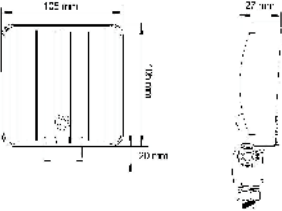

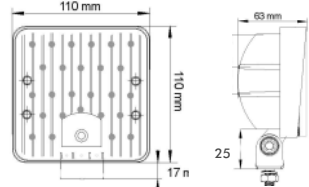





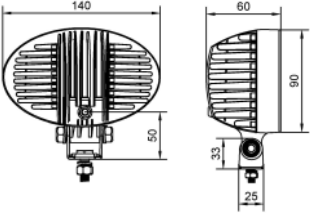

Referencia: Reference-No.	Ud. QTY	Descripción Description	Faros de Trabajo LED LED Work Lamps	Tecnología LED LED Technology
FA42-1000-401 Amplia Ilum.	1	Faro de trabajo Led Fabrilcar, 5 LEDs alta potencia de luz, carcasa plástico, cable 0,30m, 10/30V, 27W, IP67,R10, EMC Potencia de Luz: 1100 Lumen LED Work Lamp, high light 5 LED's, plastic housing, cable 0,30m, 10/30V, 27W, IP67 light performance: 1100 lumen	1100lm 	
FA42-1009-001 Amplia Ilum.	1	Faro de trabajo Led Fabrilcar, 10 LEDs alta potencia de luz, con interruptor, cable 1,50m, 10/59V, 10W, IP6K9K,R10, R23 EMC, ADR Potencia de Luz: 1600 Lumen LED Work Lamp, high light 10 LED's, with switch, cable 1,50m, 10/59V, 10W, IP6K9K, R10, R23 EMC, ADR light performance: 1600 lumen	1600lm  con interruptor	
FA42-1009-011 Amplia Ilum.	1	Faro de trabajo Led Fabrilcar, 10 LEDs alta potencia de luz, cable 1,50m, 10/59V, 10W, IP6K9K,R10, R23, EMC, ADR Potencia de Luz: 1600 Lumen LED Work Lamp, high light 10 LED's, with switch, cable 1,50m, 10/59V, 10W, IP6K9K, R10, R23 EMC, ADR light performance: 1600 lumen	1600lm 	
FA42-1006-001 Amplia Ilum.	1	Faro de trabajo Led Fabrilcar, 16 LEDs alta potencia de luz, carcasa PVC, cable 1,5m, 10/30V, 12W, IP67,R10, EMC, Potencia de Luz: 1800 Lumen LED Work Lamp and reversing lamp high light 16 LED's, plastic housing, cable 1,5m,10/30V, 12W, IP67, light performance: 1800 lumen	1800lm  Carcasa plástico	
FA42-1003-001 Amplia Ilum.	1	Faro de trabajo Led Fabrilcar, 16 LEDs alta potencia de luz, carcasa robusta de aluminio, cable 1,5m, 10/30V, 36W IP67,R10, EMC Potencia de Luz: 3500 Lumen LED Work Lamp Fabrilcar high light 16 LED's, aluminium housing, cable 1,5m,10/30V, 27W, IP67 light performance: 3500 lumen	3500lm 	

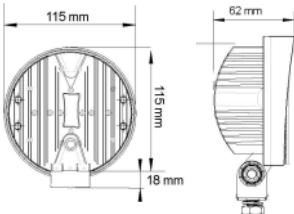
Faros de Trabajo LED

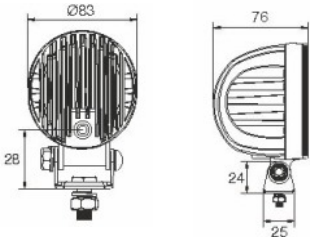
LED Work Lamps

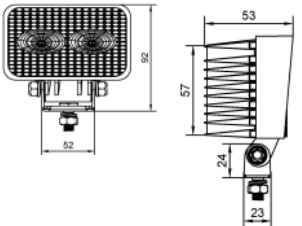

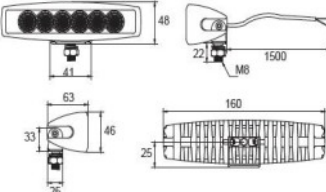
Referencia: Reference-No.	Ud. QTY	Descripción Description	Faros de Trabajo LED LED Work Lamps	Tecnología LED LED Technology
FA42-1007-001 Amplia Ilum.	1	Faro de trabajo Led Fabrilcar, 8 LEDs alta potencia de luz, carcasa robusta de aluminio, cable 1,5m, 10/30V, 16W IP67,R10, EMC Potencia de Luz: 1800 Lumen LED Work Lamp, high light 8 LED`s, aluminium housing, cable 1,5m, 10/30V, 16W, IP67 light performance: 1800 lumen	1800lm 	
FA42-1002-001 Larga Ilum.	1	Faro de trabajo Led Fabrilcar, 9 LEDs alta potencia de luz, carcasa PVC, cable 1,5m, 10/30V, 22, Ip67, R10, EMC, Potencia de Luz: 2000 Lumen LED Work Lamp Fabrilcar high light 9 LED`s, aluminium housing, cable 1,5m,10/30V, 22W, IP67, light performance: 2000 lumen	2000lm 	
FA42-1008-001 Amplia Ilum.	1	Faro de trabajo Led Fabrilcar, 4 LEDs alta potencia de luz, carcasa robusta de aluminio, cable 1,5m, 10/30V, 10W IP67,R10, EMC, R23 Marcha atrás Potencia de Luz: 900 Lumen LED Work Lamp and reversing lamp high light 4 LED`s, aluminium housing, cable 1,5m,10/30V, 10W, IP67 , R23 light performance: 900 lumen	900lm  Marcha Atrás	
FA42-1008-301 Amplia Ilum.	1	Faro de trabajo Led Fabrilcar, 2 LEDs alta potencia de luz, carcasa robusta de aluminio, cable 1,5m, 10/30V, 18W IP67,R10, EMC Potencia de Luz: 2000 Lumen LED Work Lamp Fabrilcar high light 2 LED`s, aluminium housing, cable 1,5m,10/30V, 18W, IP67 light performance: 2000 lumen	2000lm 	
FA42-1008-401 Amplia Ilum.	1	Faro de trabajo Led Fabrilcar, 8 LEDs alta potencia de luz, carcasa aluminio, cable 1,5m, 10/30V, 13W, IP67,R10, EMC, Potencia de Luz: 1300 Lumen LED Work Lamp and reversing lamp high light 6 LED`s, aluminium housing, cable 1,5m,10/30V, 13W, IP67 light performance: 2000 lumen	1300lm 	

Barra de Luces de Trabajo LED

LED Work Lightbar

Tipo: PRO-STREAM



Referencia: Reference-No.	Ud. QTY	Barra de luces de trabajo LED PRO-STREAM - 18 - 36 LED de alta potencia - 12V/24V - Perfil muy bajo - Lente moldeada de Policarbonato - Iluminación de larga distancia - Fijación: 2 Soportes - Cable 3,0m, ECE R10	LED Work Lamp PRO-STREAM - 18 - 36 high power LED's - 12V/24V - Very low profile - Polycarbonate moulded lens - long distance illumination - Fixation: 2 brackets - Cable 3,0m, ECE R10 approved
P40.433.503	1	12V 24V Largo/Length: 516mm	Ancho/Consumption: 54 Watt 3800lm
P40.433.703	1	12V 24V Largo/Length: 759mm	Ancho/Consumption: 81 Watt 5700lm
P40.433.103	1	12V 24V Largo/Length: 1002mm	Ancho/Consumption: 108 Watt 7600lm

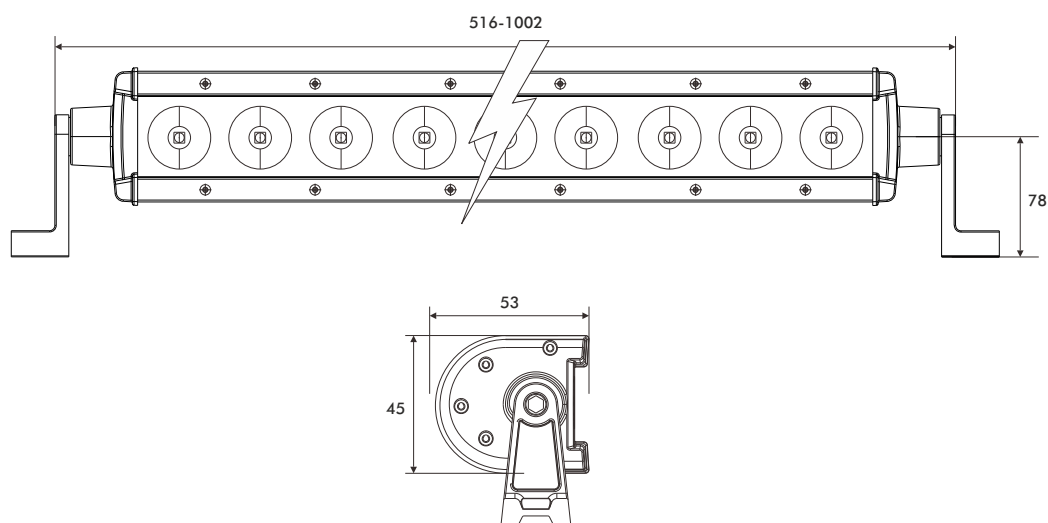

Otras medidas por encargo

Further Length on request

Barra de Luces de Trabajo LED

LED Work Light bar

Tipo: PRO-MULTI-STREAM



Referencia: Reference-No.	Ud. QTY	Barra de luces y destellante LED Acorde con la normativa ECE R65 PRO-MULTI-STREAM - 12V/24V, 18 - 30 LED Alta potencia - 19 diferentes tipos de destello - Perfil bajo - Tulipa policarbonato - Iluminación larga distancia - Fijación: 2 Pernos - Cable 3,0m, ECE R10 & R65	LED Work Lamp + LED Directional Lamp according to ECE R65 PRO-MULTI-STREAM - 12V/24V, 18 - 30 high power LED's - Directional Lamp with 19 flash pattern - Very low profile - Polycarbonate moulded lens - long distance illumination - Fixation: 2 brackets - Cable 3,0m, ECE R10 & R65 approved
P40.435.503	1	12V 24V Largo/Length: 510mm	Consumo/Consumption: 78 Watt 2000lm
P40.435.703	1	12V 24V Largo/Length: 808mm	Consumo/Consumption: 126 Watt 3200lm

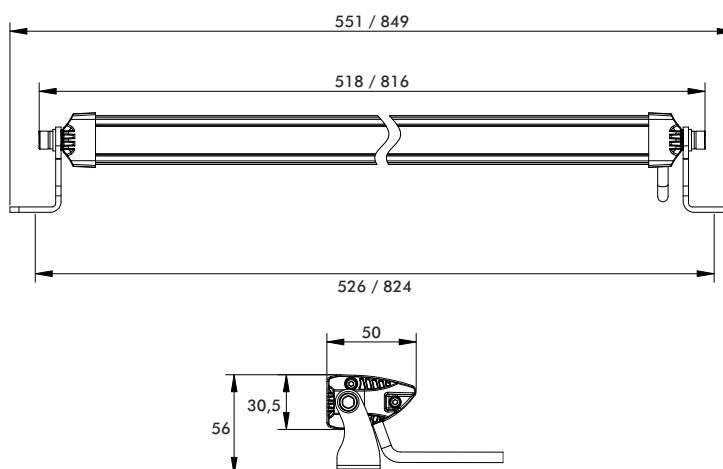

Barra de Luces de Trabajo LED

LED Work Light bar

Tipo: PRO-POWER-STREAM



Referencia: Reference-No.	Ud. QTY	Barra de luces LED PRO-POWER-STREAM - 42 - 78 LED's de alta potencia - 12V/24V - Perfil bajo - Tulipa policarbonato - Iluminación larga distancia - Fijación: 2 Pernos - Cable 3,0m, ECE R10	LED Work Lamp PRO-POWER-STREAM - 42 - 78 high power LED's - 12V/24V - low profile - Polycarbonate moulded lens - long distance illumination - Fixation: 2 brackets - Cable 3,0m, ECE R10 approved
P40.434.503	1	12V 24V Largo/Length: 594mm	Consumo/Consumption: 126 Watt 8820lm
P40.434.703	1	12V 24V Largo/Length: 828mm	Consumo/Consumption: 180 Watt 12600lm
P40.434.103	1	12V 24V Largo/Length: 1062mm	Consumo/Consumption: 234 Watt 16380lm

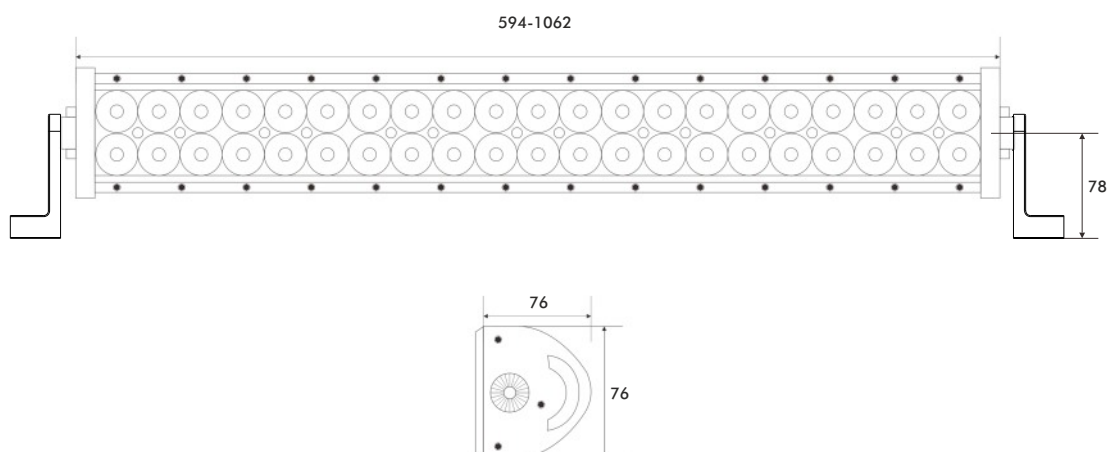

Faros Delanteros LED

LED Head Lamp

Tipo: PRO-TRACK



Referencia: Reference-No.	Ud. QTY	Descripción Description	Pilotos Posición LED LED Position Lamps	Esquema Drawing
P40.477.003	1	<p>Faro delantero LED PRO-TRACK Kit completo con el faro izquierdo y derecho Funciones: Luz de cruce Luz largo alcance Luz de día Luz de intermitencia Luz de posición</p> <p>Carcasa: Aluminio Tulipa: PC Conexión: Conector 6p. Deutsch DT incl. Adaptador</p> <p>Voltaje: 9-32 Volt Protección: IP68 Fijación: Tornillos Montaje: estandar Consumo: 82,0W</p> <p>Homolog.: 8100 Lumen SAE FMVSS108 ECE R10 (EMV) ECE R112 ECE R87 ECE R6 ECE R7</p> <p><i>LED Head Lamp Set PRO-TRACK</i> Set consist of a left head lamp and a right head lamp Function: Low Beam High Beam Day-time Running light Front Dir. Indicator light Front Position light</p> <p>Housing: Aluminium Lens: PC Connection: 6pin Deutsch DT connector incl. Adapter</p> <p>Voltage: 9-32 Volt Protection: IP68 Fixation: Screw Mounting pos.: standing Power: 82,0W 8100 Lumen High Beam</p> <p>Approval: SAE FMVSS108 ECE R10 (EMC) ECE R112 ECE R87 ECE R6 ECE R7</p>		





Cableado / Wiring:
1 - Masa/Ground
2 - Luz de cruce/Low Beam
3 - Luz largo alcance/High Beam
4 - Luz posición/Position Light
5 - Luz intermitencia/Dir.Indicator
6 - Luz de día/Daytime Running Light

Luz Marcha Atrás LED

LED Reversing Lamp

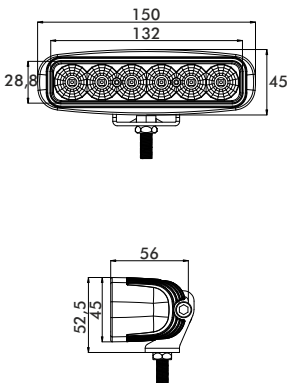
Tipo: PRO-REAR, PRO-REVERSE, PRO-FIELD

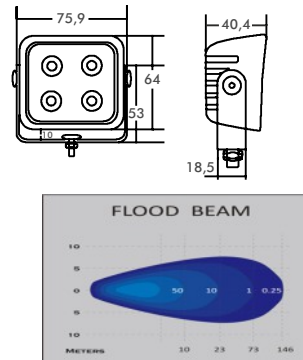

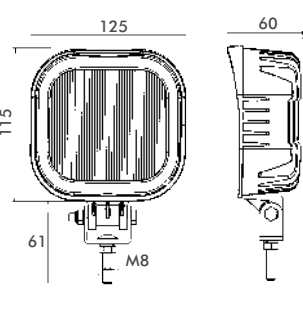
Referencia: Reference-No.	Ud. QTY	Descripción Description	Luz de Marcha Atrás Led Led reversing Lamp	Tecnología LED LED Technology
P40.474.003	1	<p>Luz de Marcha Atrás LED PRO-REVERSE II, ECE R23 Utilizable como faro de trabajo Iluminación Homogenea Carcasa: Aluminio Tulipa: PC Conexión: 0,5m puntas abiertas Voltaje: 9-32 Volt Protección: IP68 Sujección: Soporte tipo U Montaje: Estandar o colgar Homolog.: ADR EMV Consumo: 12V-18W/24V-18W 1500 Lumen C. Temper.: 5000-6500K</p> <p>LED Reversing Lamp PRO-REVERSE II according to ECE R23 Useable as work lamp Homogeneous illumination Housing: Aluminium Lens: PC Cable: 0,5m open end Voltage: 9-32 Volt Protection: IP68 Fixation: U-bracket Mounting pos.: standing or hanging Homologation: ADR approved EMC approved Power: 12V-18W/24V-18W 1500 Lumen Colour Temp.: 5000-6500K</p>		
P40.424.003	1	<p>Faro de trabajo y Luz de marcha atrás LED PRO-FIELD, iluminación homogénea, perfil extremadamente compacto, carcasa de aluminio, tulipa policarbonado, ECE R23, ECE R10 4 LEDs, cable 0,45m, ADR,9/32V, 12W, Potencia de luz: 800Lumen</p> <p>LED Reversing Lamp PRO-REVERSE, according to ECE R23, clear lens made of unbreakable PC, small, solid housing, cable 0,5m, ADR-appr., 12V/24V</p>		
P40.466.003	1	<p>Luz de marcha atrás LED PRO-REVERSE, luz de largo alcance, alta intensidad, ECE R23, LEDs de alta potencia, tulipa de policarbonato, fijación en U, cable 0,5m, ADR,12V/24V</p> <p>LED Reversing Lamp PRO-REVERSE, according to ECE R23, clear lens made of unbreakable PC, small, solid housing, cable 0,5m, ADR-appr.,12V/24V</p>		

Luz Marcha Atrás LED

LED Reversing Lamp

Tipo: PRO-TWIN-REVERSE, PRO-FIELD, PRO-BAXTER







Referencia: Reference-No.	Ud. QTY	Descripción Description	Luz de Marcha Atrás Led Led reversing Lamp	Tecnología LED LED Technology
Pxx.xxx.xy	1	<p>Luz de Marcha Atrás LED PRO-TWIN-REVERSE, ECE R23, también se puede utilizar como faro de trabajo, 1500lm, Iluminación homogénea 12LEDs de alta potencia, con Cable 0,5m, 12/24V, ADR ECE R10 Rendimiento: 1500 Lumen</p> <p><i>LED Work Lamp PRO-TWIN-REVERSE according to ECE R23, useable as Work Lamp, 1500 lumen, homogeneous illumination, cable 0,5m 12/24V, ADR and ECE R10 approved light performance: 1500 Lumen</i></p>		
P40.479.003	1	<p>Luz de Marcha Atrás LED PRO-BAXTER, ECE R23, también se puede utilizar como faro de trabajo, 1280lm, Iluminación homogénea Consumo 16W, Cable 0,22m, EMC, 9-32V</p> <p><i>LED Reversing-Work Lamp PRO-BAXTER, according to ECE R23, useable as Work Lamp, 1280 lumen, homogeneous illumination 16W, cable 0,22m, EMC appr., 9-32V</i></p>		
P40.478.003	1	<p>Luz de Marcha Atrás LED PRO-MINI-BAXTER, ECE R23, también se puede utilizar como faro de trabajo, 960lm, Iluminación homogénea Consumo 12W, Cable 0,22m, EMC, 9-32V</p> <p><i>LED Reversing-Work Lamp PRO-MINI-BAXTER, according to ECE R23, useable as Work Lamp, 960 lumen, homogeneous illumination 12W, cable 0,22m, EMC appr., 9-32V</i></p>		

Faros Auxiliares

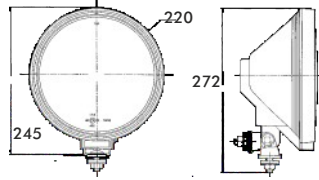
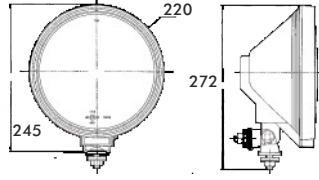
Spot Lamp

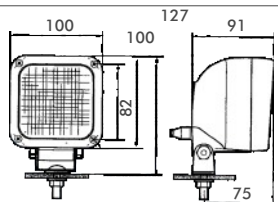

Referencia: Reference-No.	Ud. QTY	Descripción Description	Faro Auxiliar Spot Lamps	P14,5s/H1/ BA9s/T4W
P40.454.003	1	<p>Faro auxiliar H1 con luz de estacionamiento, cristal transparente, carcasa de plástico sólido y resistente, completamente cableado H1 24V/70W, 24V/4W</p> <p>H1-Spot Lamp with parking light, glass Lens, solid plastic housing, complete cabled and with bulbs H1 24V/70W+24V/4W</p>		<p>P14,5s/H1 + BA9s/T4W</p> 
P40.454.013	1	<p>Faro auxiliar H1 con luz de estacionamiento, cristal azul, carcasa de plástico sólido y resistente, completamente cableado H1 24V/70W, 24V/4W</p> <p>H1-Spot Lamp with parking light, glass Lens blue, solid plastic housing, complete cabled and with bulbs H1 24V/70W+24V/4W</p>		<p>P14,5s/H1 + BA9s/T4W</p> 
P40.407.003	1	<p>Luz antiniebla LED PRO-FOG II, carcasa metálica robusta, tulipa de policarbonato, 1000 Lm, ECE R19 & ECE R10 12V/24V - 12W</p> <p>LED Fog Lamp PRO-FOG II, solid metal housing, Lens made of Polycarbonat, 1000 lm, ECE R19 & ECE R10 appr., 12V/24V - 12W</p>	<p>1000lm</p> 	
P40.403.003	1	<p>Faro de trabajo H3 pequeño con cristal transparente, iluminación amplia e intensa, carcasa de plástico sólido y resistente, asa, H3 12V/24V</p> <p>H3-Work Lamp, Glass Lens with grill for wide illumination, housing with handle and switch H3 12V/24V</p>		
P40.448.003	1	<p>Faro de trabajo H3 pequeño con cristal transparente, iluminación amplia e intensa, carcasa sólida y resistente, conector trasero, fijación en U ADR, IP54, H3 12V/24V</p> <p>H3-Work Lamp, with Glass Lens for extreme wide illumination, small, solid housing, ADR-appr., IP54 H3 12V/24V</p>	 <p>Conector trasero Backside Connector</p> 	 

Rotativos LED	LED Beacons	7.0	- 7.7
Rotativos	Rotating Beacons	7.8	- 7.13
Destellantes Xenon	Xenon Beacons	7.14	- 7.17
Soportes Sujeción	Pole Mount Brackets	7.18	
Puentes Luminosos	Lightbars	7.19	- 7.18



Destellante LED

LED Beacons

Tipo: PRO-TWIN-CAN, PRO-THIN-CAN



Referencia: Reference-No.	Ud. QTY	Descripción Description	Pilotos Posición LED LED Position Lamps	Esquema Drawing
P40.076.001	1	<p>Destellante LED PRO-TWIN-CAN, ECE R65 & R10, Diseño compacto carcasa metalizada, Flash simple/doble flash, se puede sincronizar, Cable 0,5m, 12V/24V, ADR , IP6K9K Fijación: Superficie</p> <p><i>LED Directional Lamp PRO-TWIN-CAN, according to ECE R65 & R10, compact profile, metalized cover, adapted to synchronisation, single flash/double flash, cable 0,5m, ADR approved, 12V/24V IP6K9K, pendant</i></p>		
P40.076.701	1	<p>Destellante LED PRO-TWIN-CAN, Fijación: Empotrable</p> <p><i>LED Directional Lamp PRO-TWIN-CAN, recessed</i></p>		
P40.076.041	1	<p>Destellante LED PRO-TWIN-CAN "black edition", ECE R65 & R10, Diseño compacto, carcasa metalizada, Flash simple/doble flash, se puede sincronizar, Cable 0,5m, 12V/24V, ADR , IP6K9K Fijación: Superficie</p> <p><i>LED Directional Lamp PRO-TWIN-CAN „Black Edition“, according to ECE R65 & R10, compact profile, single flash/double flash, adapted to synchronisation, cable 0,5m, ADR approved, 12V/24V IP6K9K, pendant</i></p>		
P40.076.741	1	<p>LED Kennleuchte PRO-TWIN-CAN, Befestigung: Aufbau</p> <p><i>LED Directional Lamp PRO-TWIN-CAN, recessed</i></p>		
Pyy-yyy-yyy	1	<p>Destellante LED PRO-THIN-CAN, ECE R65 & R10, Diseño plano, Flash simple/doble flash, se puede sincronizar, Cable 0,5m, 12V/24V, ADR, IP6K9K Fijación: Superficie</p> <p><i>LED Directional Lamp PRO-THIN-CAN, according to ECE R65 & R10, flat profile, single flash/double flash, adapted to synchronisation, cable 0,5m, ADR approved, 12V/24V IP6K9K, pendant</i></p>		

Rotativo LED

LED Beacon

Tipo: PRO-MULTI-FLASH II, PRO-INDU-FLASH



Referencia: Reference-No.	Ud. QTY	Descripción Description	Rotativo LED LED Beacons	ECE R65 According to ECE R65
P40.599.001	1	<p>Rotativo LED PRO-MULTI-FLASH II acorde con las normativas ECE R65, R10, 18 potentes LED´s, diseño plano, 9V/30V - 27W, temperatura de trabajo -30°/+60° IP67, 8 tipos diferentes de destellos Fijación:: 3 - Pernos</p> <p>LED Beacon PRO-MULTI-FLASH II according to ECE R65, R10, 18-POWER-LED´s, very low profile, 9V/30V, operating temp. -30° - +60°, lens made of PC, 8 flash pattern Fixation: 3 bolt</p>	 	
P40.599.201	1	<p>Rotativo LED PRO-MULTI-FLASH II acorde con las normativas ECE R65, R10, 18 potentes LED´s, diseño plano, 9V/30V - 27W, temperatura de trabajo -30°/+60° IP67, 8 tipos diferentes de destellos Fijación:: Pincho flexible</p> <p>LED Beacon PRO-MULTI-FLASH II according to ECE R65, R10, 18-POWER-LED´s, very low profile, 9V/30V, operating temp. -30° - +60°, lens made of PC, 8 flash pattern Fixation: flex. Pole Mount</p>	 	
P40.599.301	1	<p>Rotativo LED PRO-MULTI-FLASH II acorde con las normativas ECE R65, R10, 18 potentes LED´s, diseño plano, 9V/30V - 27W, temperatura de trabajo -30°/+60° IP67, 8 tipos diferentes de destellos Fijación:: Magnética / ventosa</p> <p>LED Beacon PRO-MULTI-FLASH II according to ECE R65, R10, 18-POWER-LED´s, very low profile, 9V/30V, operating temp. -30° - +60°, lens made of PC, 8 flash pattern Fixation: Vacuum/Magnetic</p>	 <p>Boton selector flash Flash Pattern Selector</p> 	
P40.598.001	1	<p>Rotativo LED PRO-INDU-FLASH Extremadamente plano, led de alta intensidad especial para carretillas ECE R10, 10/110V, IP66, Fijación:: 3 pernos</p> <p>LED Beacon PRO-INDU-FLASH extreme low profile, high intensity LED Beacon special for fork-lift quad flash, 10/110V, ECE R10, IP66 Fixation: 3-bolt</p>	 	

Rotativo LED

LED Beacon

Tipo: PRO-MULTI-FLASH II,



Referencia: Reference-No.	Ud. QTY	Descripción Description	Rotativo LED LED Beacons	ECE R65 According to ECE R65
P40.599.011	1	<p>Rotativo LED PRO-MULTI-FLASH II acorde con las normativas ECE R65, R10, 18 potentes LED´s, diseño plano, 9V/30V - 27W, temperatura de trabajo -30°/+60° IP67, 8 tipos diferentes de destellos Fijación:: 3 - Pernos</p> <p>LED Beacon PRO-MULTI-FLASH II according to ECE R65, R10, 18-POWER-LED´s, very low profile, 9V/30V, operating temp. -30° - +60°, lens made of PC, 8 flash pattern Fixation: 3 bolt</p>		
P40.599.211	1	<p>Rotativo LED PRO-MULTI-FLASH II acorde con las normativas ECE R65, R10, 18 potentes LED´s, diseño plano, 9V/30V - 27W, temperatura de trabajo -30°/+60° IP67, 8 tipos diferentes de destellos Fijación:: Pincho flexible</p> <p>LED Beacon PRO-MULTI-FLASH II according to ECE R65, R10, 18-POWER-LED´s, very low profile, 9V/30V, operating temp. -30° - +60°, lens made of PC, 8 flash pattern Fixation: flex. Pole Mount</p>		
P40.599.311	1	<p>Rotativo LED PRO-MULTI-FLASH II acorde con las normativas ECE R65, R10, 18 potentes LED´s, diseño plano, 9V/30V - 27W, temperatura de trabajo -30°/+60° IP67, 8 tipos diferentes de destellos Fijación:: Magnética / ventosa</p> <p>LED Beacon PRO-MULTI-FLASH II according to ECE R65, R10, 18-POWER-LED´s, very low profile, 9V/30V, operating temp. -30° - +60°, lens made of PC, 8 flash pattern Fixation: Vacuum/Magnetic</p>		

Rotativo LED

LED Beacon

Tipo: PRO-MULTI-FLASH II









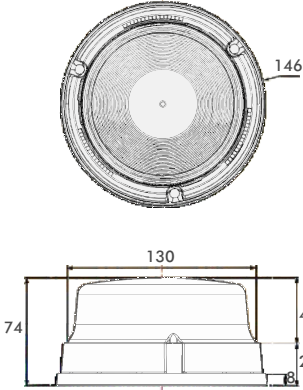

Referencia: Reference-No.	Ud. QTY	Descripción Description	Rotativo LED LED Beacons	ECE R65 According to ECE R65
P40.599.701	1	<p>Rotativo LED PRO-MULTI-FLASH II acorde con las normativas ECE R65, R10, 18 potentes LED´s, diseño plano, 9V/30V - 27W, temperatura de trabajo -30°/+60° IP67, 8 tipos diferentes de destellos Fijación:: 3 - Pernos</p> <p>LED Beacon PRO-MULTI-FLASH II according to ECE R65, R10, 18-POWER-LED´s, very low profile, 9V/30V, operating temp. -30° - +60°, lens made of PC, 8 flash pattern Fixation: 3 bolt</p>		
P40.599.801	1	<p>Rotativo LED PRO-MULTI-FLASH II acorde con las normativas ECE R65, R10, 18 potentes LED´s, diseño plano, 9V/30V - 27W, temperatura de trabajo -30°/+60° IP67, 8 tipos diferentes de destellos Fijación:: Pincho flexible</p> <p>LED Beacon PRO-MULTI-FLASH II according to ECE R65, R10, 18-POWER-LED´s, very low profile, 9V/30V, operating temp. -30° - +60°, lens made of PC, 8 flash pattern Fixation: flex. Pole Mount</p>		
P40.599.901	1	<p>Rotativo LED PRO-MULTI-FLASH II acorde con las normativas ECE R65, R10, 18 potentes LED´s, diseño plano, 9V/30V - 27W, temperatura de trabajo -30°/+60° IP67, 8 tipos diferentes de destellos Fijación:: Magnética / ventosa</p> <p>LED Beacon PRO-MULTI-FLASH II according to ECE R65, R10, 18-POWER-LED´s, very low profile, 9V/30V, operating temp. -30° - +60°, lens made of PC, 8 flash pattern Fixation: Vacuum/Magnetic</p>		 <p>Boton selector flash Flash Pattern Selector</p>

Rotativo LED

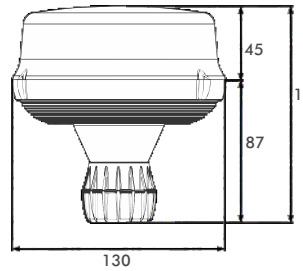
LED Beacon

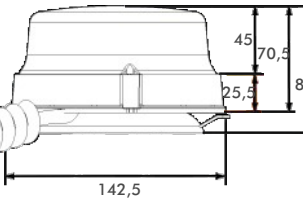
Tipo: PRO-POWER-FLASH, PRO-ROTA-FLASH



Referencia: Reference-No.	Ud. QTY	Descripción Description	Rotativo LED LED Beacons	ECE R65 According to ECE R65
P40.551.001	1	<p>Rotativo LED PRO-POWER-FLASH acorde con las normativas ECE R65, R10, 8 potentes LED´s, diseño plano, 12V/24V - 9W, máximo consumo 700mA, temperatura de trabajo -20°/+50° tulipa policarbonato, Fijación:: 3 - Pernos</p> <p>LED Beacon PRO-POWER-FLASH according to ECE R65, R10, 8-POWER-LED´s, 12V/24V - 9W, max. consumption 700mA, operating temp. -20° - +50°, lens made of PC, very low profile Fixation: 3 bolt</p>		
P40.551.401	1	<p>Rotativo LED PRO-ROTA-FLASH</p>		
P40.551.201	1	<p>Rotativo LED PRO-POWER-FLASH acorde con las normativas ECE R65, R10, 8 potentes LED´s, diseño plano, 12V/24V - 9W, máximo consumo 700mA, temperatura de trabajo -20° - +50° tulipa policarbonato, Fijación:: Pincho flexible</p> <p>LED Beacon PRO-POWER-FLASH according to ECE R65, R10, 8-POWER-LED´s, 12V/24V - 9W, max. consumption 700mA, operating temp. -20° - +50°, lens made of PC, very low profile Fixation: flex. Pole Mount</p>		
P40.551.501	1	<p>Rotativo LED PRO-ROTA-FLASH</p>		
P40.551.301	1	<p>Rotativo LED PRO-POWER-FLASH acorde con las normativas ECE R65, R10, 8 potentes LED´s, diseño plano, 12V/24V - 9W, máximo consumo 700mA, temperatura de trabajo -20° - +50° tulipa policarbonato, Fijación:: Magnética</p> <p>LED Beacon PRO-POWER-FLASH according to ECE R65, R10, 8-POWER-LED´s, 12V/24V - 9W, max. consumption 700mA, operating temp. -20° - +50°, lens made of PC, very low profile Fixation: Vacuum/Magnetic</p>		
P40.551.601	1	<p>Rotativo LED PRO-ROTA-FLASH</p>		
P40.551.101	1	<p>Tulipa transparente Lens clear</p>		
P50.024.000	1	<p>Junta de goma para fijación Rubber base for roof fixation</p>		<p>Inclinación 3,6°/Inclination 15</p> 

Rotativo LED

LED Beacon

Tipo: PRO-SUPER-FLASH, PRO-ROTA-FLASH XL



Referencia: Reference-No.	Ud. QTY	Descripción Description	Rotativo LED LED Beacons	ECE R65 According to ECE R65
P40.570.001	1	<p>Rotativo LED PRO-SUPER-FLASH acorde con las normativas ECE R65, R10, 8 potentes LED´s, diseño plano, 12V/24V - 9W, máximo consumo 700mA, temperatura de trabajo -20°/+50° tulipa policarbonato, Fijación:: 3 - Pernos</p> <p>LED Beacon PRO-SUPER-FLASH according to ECE R65, R10, 8-POWER-LED´s, 12V/24V - 9W, max. consumption 700mA, operating temp. -20° - +50°, lens made of PC, very low profile Fixation: 3 bolt</p>		
P40.570.401	1	<p>Rotativo LED PRO-ROTA-FLASH XL</p>		
P40.570.201	1	<p>Rotativo LED PRO-SUPER-FLASH acorde con las normativas ECE R65, R10, 8 potentes LED´s, diseño plano, 12V/24V - 9W, máximo consumo 700mA, temperatura de trabajo -20°+50° tulipa policarbonato, Fijación:: Pincho flexible</p> <p>LED Beacon PRO-SUPER-FLASH according to ECE R65, R10, 8-POWER-LED´s, 12V/24V - 9W, max. consumption 700mA, operating temp. -20° - +50°, lens made of PC, very low profile Fixation: flex. Pole Mount</p>		
P40.570.501	1	<p>Rotativo LED PRO-ROTA-FLASH XL</p>		
P40.570.601	1	<p>Rotativo LED PRO-ROTA-FLASH acorde con las normativas ECE R65, R10, 8 potentes LED´s, diseño plano, 12V/24V - 9W, máximo consumo 700mA, temperatura de trabajo -20°+50° tulipa policarbonato, Fijación:: Magnética</p> <p>LED Beacon PRO-SUPER-FLASH according to ECE R65, R10, 8-POWER-LED´s, 12V/24V - 9W, max. consumption 700mA, operating temp. -20° - +50°, lens made of PC, very low profile Fixation: Vacuum/Magnetic</p>		
P40.570.101	1	<p>Tulipa transparente Lens clear</p>		
P50.024.000	1	<p>Junta de goma para fijación Rubber base for roof fixation</p>		<p>Inclinación 3,6°/inclination 15</p>



PROPLAST

FAHRZEUGBELEUCHTUNG

www.aspock.com

Catálogo 2022/2023

Rotativo LED

LED Beacon

Tipo: PRO-ECO-FLASH II









Referencia: Reference-No.	Ud. QTY	Descripción Description	Rotativo LED LED Beacons
P40.665.701	1	<p>Rotativo LED PRO-ECO-FLASH II EMC, ECE R10, 32 LED´s, 10-30V, tulipa policarbonatro, Fijación: 3 - Pernos</p> <p>LED Beacon PRO-ECO-FLASH II EMC approved ECE R10, 32 LED´s, 10-30V, lens made of PC, Fixation: 3 bolt</p>	  <p>Tipos de Flash: Flash Patterns Rotativa Destellante Mega Flash Off</p>
P40.665.801	1	<p>Rotativo LED PRO-ECO-FLASH II EMC, ECE R10, 32 LED´s, 10-30V, tulipa policarbonatro, Fijación: Pincho flexible</p> <p>LED Beacon PRO-ECO-FLASH II EMC approved ECE R10, 32 LED´s, 10-30V, lens made of PC, Fixation: flex. Pole Mount</p>	 
P40.665.901	1	<p>Rotativo LED PRO-ECO-FLASH II EMC, ECE R10, 32 LED´s, 10-30V, tulipa policarbonatro, Fijación: Magnética/ventosa</p> <p>LED Beacon PRO-ECO-FLASH II EMC approved ECE R10, 32 LED´s, 10-30V, lens made of PC, Fixation: Magnetic</p>	 <p>Boton Selector Flash Flash Pattern Selector</p>  <p>Tipos de Flash Flash Patterns Rotativo Destellante Mega flash Off</p>

Rotativo LED

LED Beacon

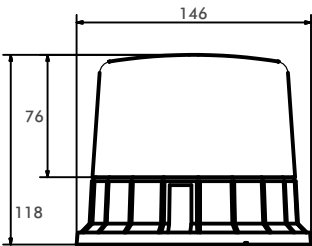
Tipo: PRO-SUPER-FLASH C

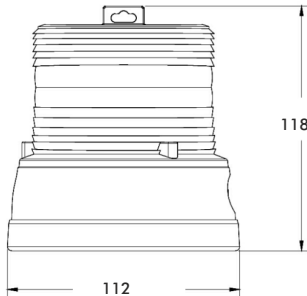

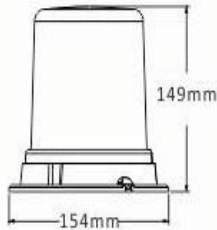
Referencia: Reference-No.	Ud. QTY	Descripción Description	Rotativo LED LED Beacons	ECE R65 According to ECE R65
P40.570.701	1	<p>Rotativo LED PRO-SUPER-FLASH C acorde con las normativas ECE R65, R10, 8 potentes LED´s, diseño plano, 12V/24V - 9W, máximo consumo 700mA, temperatura de trabajo -20°/+50° tulipa transparente policarbonato, Fijación: 3 - Pernos</p> <p>LED Beacon PRO-MULTI-FLASH according to ECE R65, R10, 8-POWER-LED´s, very low profile, 12V/24V, max. consumption 700mA, operating temp. -30° - +50°, lens made of PC, Fixation: 3 bolt flash pattern: flashing / rotating light</p>	 	
P40.596.001	1	<p>Rotativo LED PRO-BATTERY-FLASH EMC, ECE R10, 16 SMD, IP66 2 tipos de flash: destellante 1 solo flash 60 por minuto, rotativo flash 105 por minuto, 4 x 1.5V AA * baterías no incluidas Tiempo de trabajo 260-300H. Fijación: Imán/Magnética</p> <p>LED Beacon PRO-BATTERY-FLASH ECE R10, 16-POWER-LED´s, IP66, 2 patterns, single flash 60 flashes minute, rotation flash, 105 flashes minute. 4 x 1.5V AA batteries not included, operation time ca. 260-300H, Fixation: Vacuum/Magnetic</p>		
P40.516.011	1	<p>Rotativo LED Azul acorde con las normativas ECE R65, R10, 12V/24V Fijación: 3 - Pernos</p>		

Rotativo LED

LED Beacon

Tipo: FABRILCAR



Referencia: Reference-No.	Ud. QTY	Descripción Description	Rotativo LED LED Beacons	ECE R65 According to ECE R65
FA42-4404-011	1	Rotativo LED, ECE R10, R65, 4 diferentes tipos de señal, EMC, ADR, Ip67, 9-30V, 12W Fijación: Tipo Pincho Flexible LED Beacon, approved ECE R10, R65, 4 Different flash patterns, EMC, IP67, 9-30V, 12W Fixation: Flexible DIN connector		
FA42-4404-051	1	Rotativo LED, ECE R10, R65, 4 diferentes tipos de señal, EMC, ADR, Ip67, 9-30V, 12W Fijación: 3 pernos LED Beacon, approved ECE R10, R65, 4 Different flash patterns, EMC, IP67, 9-30V, 12W Fixation: 3 Bolts		
FA42-4404-061	1	Rotativo LED, ECE R10, R65, 4 diferentes tipos de señal, EMC, ADR, Ip67, 9-30V, 12W Fijación: 3 pernos +base Magnética LED Beacon, approved ECE R10, R65, 4 Different flash patterns, EMC, IP67, 9-30V, 12W Fixation: 3 Bolts + Magnetic		
FA42-4404-001	1	Tulipa rotativo Led Lens LED Beacon		

Rotativo LED

LED Beacon

Tipo: FABRILCAR



Referencia: Reference-No.	Ud. QTY	Descripción Description	Rotativo LED LED Beacons	ECE R65 According to ECE R65
FA42-4404-131	1	Rotativo LED, ECE R10, R65, 4 diferentes tipos de señal, EMC, ADR, Ip67, 9-30V, 12W Fijación: Tipo Pincho Flexible LED Beacon, approved ECE R10, R65, 4 Different flash patterns, EMC, IP67, 9-30V, 12W Fixation: Flexible DIN connector		
FA42-4404-151	1	Rotativo LED, ECE R10, R65, 4 diferentes tipos de señal, EMC, ADR, Ip67, 9-30V, 12W Fijación: 3 pernos LED Beacon, approved ECE R10, R65, 4 Different flash patterns, EMC, IP67, 9-30V, 12W Fixation: 3 Bolts		
FA42-4404-161	1	Rotativo LED, ECE R10, R65, 4 diferentes tipos de señal, EMC, ADR, Ip67, 9-30V, 12W Fijación: 3 pernos +base Magnética LED Beacon, approved ECE R10, R65, 4 Different flash patterns, EMC, IP67, 9-30V, 12W Fixation: 3 Bolts + Magnetic		
FA42-4404-101	1	Tulipa rotativo Led Lens LED Beacon		
FA42-4504-001	1	Rotativo LED, ECE R10, 3 diferentes tipos de señal, EMC, ADR, IP66, 9-30V, 8W Fijación: Tipo Pincho Flexible LED Beacon, approved ECE R10, 3 Different flash patterns, EMC, IP66, 9-30V, 8W Fixation: Flexible DIN connector		

Destellante LED

LED Beacon

Tipo: PRO-FLASH II



Referencia: Reference-No.	Ud. QTY	Descripción Description	Destellante LED LED Beacons	ECE R65 According to ECE R65
P40.590.001	1	<p>Destellante LED PRO-FLASH II doble destello, conmutable al balizamiento, acorde a las normativas ECE R65, R10, tulipa policarbonato, 12V/24V, Fijación:: 3 - Pernos</p> <p>LED Beacon PRO-FLASH II, double flash version, switchable to simulated rotate, according to ECE R65, 12V/24V, lens made of unbreakable PC Fixation: 3 bolt</p>		
P40.590.101	1	<p>Tulipa ámbar Lens amber</p>		
P40.591.001	1	<p>Destellante LED PRO-FLASH II doble destello, conmutable al balizamiento, acorde a las normativas ECE R65, R10, tulipa policarbonato, 12V/24V, Fijación:: Pincho</p> <p>LED Beacon PRO-FLASH II, double flash version, according to ECE R65, 12V/24V, lens made of unbreakable PC Fixation: Pole Mount</p>		
P40.590.101	1	<p>Tulipa ámbar Lens amber</p>		
P40.592.001	1	<p>Destellante LED PRO-FLASH II doble destello, conmutable al balizamiento, acorde a las normativas ECE R65, R10, tulipa policarbonato, 12V/24V, Fijación:: Pincho flexible</p> <p>LED Beacon PRO-FLASH II, double flash version, according to ECE R65, 12V/24V, lens made of unbreakable PC Fixation: Flex. Pole Mount</p>		
P40.590.101	1	<p>Tulipa ámbar Lens amber</p>		
P40.593.001	1	<p>Destellante LED PRO-FLASH II doble destello, conmutable al balizamiento, acorde a las normativas ECE R65, R10, tulipa policarbonato, 12V/24V, Fijación:: Magnética</p> <p>LED Beacon PRO-FLASH II, double flash version, according to ECE R65, 12V/24V, lens made of unbreakable PC Fixation: Magnetic</p>		
P40.590.101	1	<p>Tulipa ámbar Lens amber</p>		

Luces direccionales LED

LED Beacon

Tipo: PRO-STROBE

















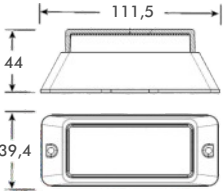



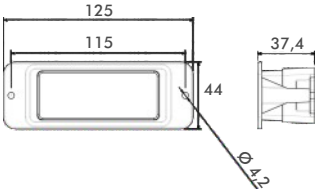

Referencia: Reference-No.	Ud. QTY	Descripción Description	Luces direccionales LED LED Beacons	ECE R65 According to ECE R65
P40.694.001	1	<p>Luz direccional LED PRO-STROBE, acorde con la normativa ECE R65, 9V - 36V, consumo 12V/18W-1,5A, 24V/20W-0,84A, carcasa robusta de aluminio, cable 1,80m, ADR, IP6K9K, montaje superficie</p> <p>LED Beacon PRO-STROBE, according to ECE R65, 9V - 36V, consumption 12V/18W, 24V/20W, aluminium die cast housing, cable 1,80m, ADR approved, IP6K9K, surface mount</p>		  
P40.694.011	1	<p>Luz direccional LED PRO-STROBE, AZUL</p>		  
P40.694.201	1	<p>Luz direccional LED PRO-STROBE, acorde con la normativa ECE R65, 9V - 36V, consumo 12V/18W-1,5A, 24V/20W-0,84A, carcasa robusta de aluminio, cable 1,80m, ADR, IP6K9K, montaje con perno de fijación</p> <p>LED Beacon PRO-STROBE, according to ECE R65, 9V - 36V, consumption 12V/18W, 24V/20W, aluminium die cast housing, cable 1,80m, ADR approved, IP6K9K, bracket mount</p>		  
P40.589.001	1	<p>Luz direccional LED PRO-STROBE II, acorde con la normativa ECE R65 & ECE R10, extremadamente de bajo consumo 12V/24W, cable 0.25m, 12 diferentes tipos de flash, sincronizados o alternativos</p> <p>LED Beacon PRO-STROBE, according to ECE R65, 9V - 36V, consumption 12V/23W, 24V/23W, aluminium die cast housing, cable 1,80m, ADR approved, IP6K9K, bracket mount</p>		  
P40.589.011	1	<p>Luz direccional LED PRO-STROBE II AZUL</p>		 

Luces direccionales LED

LED Beacon

Tipo: PRO-MINI-STROBE, PRO-FLAT-STROBE

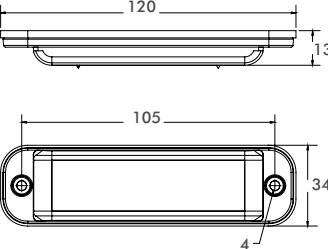

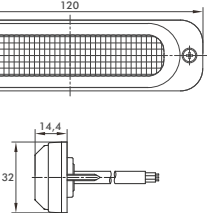









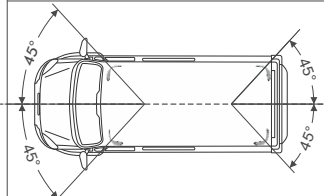
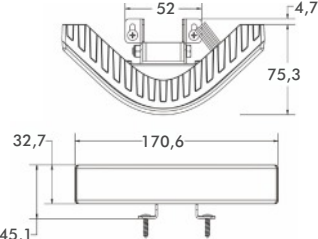

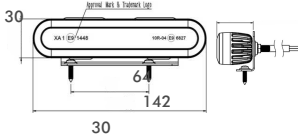
Referencia: Reference-No.	Ud. QTY	Descripción Description	Luces direccin. LED LED Beacons	ECE R65 According to ECE R65
P40.506.001	1	<p>Piloto direccional LED PRO-MINI-STROBE, ámbar, flash sincronizado o alternativo, señal de advertencia, precableado, ADR, 12V/24V, versión superficie</p> <p>LED Beacon PRO-MINI-STROBE, amber, integr. Power supply, synchronous or alternate flash, incl. cable, ADR-appr., 12/24V, surface mount version</p>	   	<p>ámbar/amber 12V - 20W / 24V - 35W</p> <p>azul/blue 12V - 25W / 24V - 35W</p>  
P40.506.011	1	<p>Piloto direccional LED PRO-MINI-STROBE, azul</p> <p>LED Beacon PRO-MINI-STROBE, version in blue</p>		
P40.505.001	1	<p>Piloto direccional LED PRO-MINI-STROBE, ámbar, flash sincronizado o alternativo, señal de advertencia, precableado, ADR, 12V/24V, versión empotrable</p> <p>LED Beacon PRO-MINI-STROBE, amber, integr. Power supply, synchronous or alternate flash, incl. cable, ADR-appr., 12/24V, flush mount version</p>	   	<p>ámbar/amber 12V - 20W / 24V - 35W</p> <p>azul/blue 12V - 25W / 24V - 35W</p>  <p>Medidas alojamiento/blanking 105mm x 38mm</p> 
P40.505.011	1	<p>Piloto direccional LED PRO-MINI-STROBE, azul</p> <p>LED Beacon PRO-MINI-STROBE, version in blue</p>		
P40.589.021	1	<p>Piloto direccional LED PRO-FLAT-STROBE II, ámbar y azul ultraplano, montaje horizontal, 12/24V, 12 diferentes tipos de flash sincronizado o alternativo, cable 0.20m</p> <p>LED Beacon PRO-FLAT-STROBE II, amber & blue, according to ECE R65 & ECE R10, extreme low profile, 12 flash patterns, synchronous or alternate flash, waterproof casted, cable 0,21m, 12V/24V</p>	 	
P40.507.701	1	<p>Piloto direccional LED PRO-INTER-STROBE, ámbar, cable 7m, 12/24V ECE R10 & R65, SAEJ595, IP6K9K</p> <p>LED Beacon PRO-INTER-STROBE, amber, cable 7m, 12/24V, ECE R10, R65, SAEJ595</p>	 	

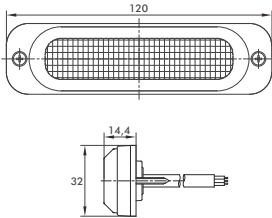
Luces direccionales LED

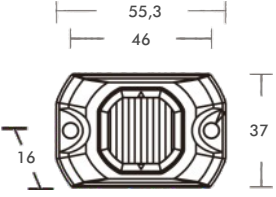
LED Beacon



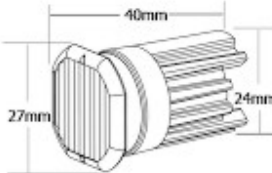





Referencia: Reference-No.	Ud. QTY	Descripción Description	Luces direccin. LED LED Beacons	ECE R65 According to ECE R65
P40.594.001	1	<p>Piloto direccional LED ámbar PRO-CORNER-STROBE, ECE R65 'X', 'HT', 'T' & ECE R10, 7 diferentes tipos de flash, sincronizados o alternativos cable 0.5m, 12V/24V</p> <p>LED Beacon PRO-CORNER-STROBE, amber, according to ECE R65 'X', 'HT', 'T' & R10, 7 flash patterns, synchro. or alternate flash, cabl 0,5m</p>	  	 <p>Cobertura de advertencia de 360° con 4 PRO-CORNER- STROBE. Max. distancia entre Rotativos Led 10m</p> <p>360° warning coverage with 4 PRO-CORNER-STROBE. Max. distance between LED</p>
P40.552.501	1	<p>Piloto direccional LED PRO-POWER-STROBE, ECE R65 & ECE R10, 10 tipos de destello diferentes, sincronizados o alternativos, Cable 1,0m, 12V/24V</p> <p>LED Beacon PRO-POWER-STROBE amber, according to ECE R65 & R10, 21 flash pattern, synchronous or alternate flash, waterproof casted, cable 1,0m, 12V/24V</p>	 	
P40.507.501	1	<p>Piloto direccional LED PRO-INTER-STROBE, ámbar, diseño plano, 10 diferentes tipos de advertencia, flash sincronizada o alternativa, a prueba de agua, cable 0,5m, 12/24V ECE R10 & R65, SAEJ595</p> <p>LED Beacon PRO-SUPER-STROBE, amber, very low profile, 10 flash patterns, synchronous or alternate flash, waterproof casted, cable 0.5m, 12/24V, ECE R10, R65, SAEJ595</p>	 	
P40.508.601	1	<p>Piloto Direccional LED ámbar PRO-MICRO-STROBE II, ECE R65, R10, 26 diferente tipos de advertencia sincronizada o alternativa, a prueba de agua cable 3,2m, 12V/24V</p> <p>LED Beacon PRO-MICRO-STROBE II, amber, ECE R65, R10, synchronous or alternate flash, 26 flash pattern, surface mount, waterproof casted, cable 3,2m, 12V/24V</p>	 	
P40.508.901	1	<p>Piloto direccional LED PRO-MICRO- STROBE, ámbar, ECE R65, R10, 200lumen, 23 tipos de advertencia, IP67, cable 3,2m, 9V/30V</p> <p>LED Beacon PRO-MICRO-STROBE II, flush or bracket mounted</p>	  	

Luces direccionales LED

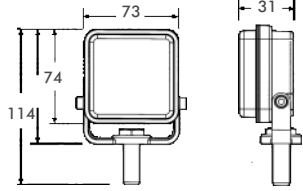
LED Beacon

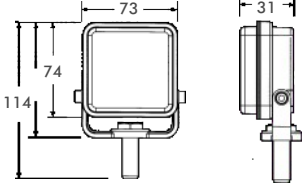

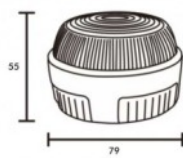
Referencia: Reference-No.	Ud. QTY	Descripción Description	Luces direccin. LED LED Beacons	ECE R65 According to ECE R65
P40.521.501	1	<p>Piloto direccional LED ámbar, ECE R10, R65, con unidad de control integrado, 24 diferentes funciones de advertencia, tulipa transparente, LED de colores. Fijación: superficie o perno</p> <p>LED Directional Beacon amber, ECE R10, R65, integr. Power supply, 24 selectable flash patterns, clear lens with coloured LED's, surface or bracket mount</p>	 	
P40.521.511	1	<p>Piloto direccional LED azul, ECE R10, R65, con unidad de control integrado, 24 diferentes funciones de advertencia, tulipa transparente, LED de colores. Fijación: superficie o perno</p> <p>LED Directional Beacon blue ECE R10, R65, integr. Power supply, 24 selectable flash patterns, clear lens with coloured LED's, surface or bracket mount</p>	 	
P40.523.501	1	<p>Rotativo LED pequeño 20 Leds SMD, cable 0.35m 10/110V, Ip67, ECE R10 Fijación: 2 pernos</p> <p>LED Beacon low profile, 20 SMD, cable 0.35m Multivoltage 10-48V, Ip67 Fixation: 2 Bolts</p>		

Rotativos

Rotating Beacon

Tipo: PRO-EUROLINE

Referencia: Reference-No.	Ud. QTY	Descripción Description	Rotativos Rotating Beacons	P 14,5s / H1 Riemenantrieb/Belt Drive
P40.501.001	1	Rotativo PRO-EUROLINE 12V / 24V tulipa policarbonato Fijación: 3 Pernos		
P40.501.101	1	Tulipa ámbar Lens amber		
P40.502.001	1	Rotativo PRO-EUROLINE 12V / 24V tulipa policarbonato Fijación: Pincho		
P40.501.101	1	Tulipa ámbar Lens amber		
P40.503.001	1	Rotativo PRO-EUROLINE 12V / 24V tulipa policarbonato Fijación: Pincho Flexible		
P40.501.101	1	Tulipa ámbar Lens amber		
P40.504.001	1	Rotativo PRO-EUROLINE 12V / 24V tulipa policarbonato Fijación: Magnética		
P40.501.101	1	Tulipa ámbar Lens amber		
G501203	1	Lámpara H1 12V/55W Bulb H1 12V/55W		
G502403	1	Lámpara H1 24V/70W Bulb H1 24V/70W		
P50.307.024	1	Base de goma para rotativo Rubber base for beacon 40 501 001		

Rotativo

Beacon

Tipo: FABRILCAR

Referencia: Reference-No.	Ud. QTY	Descripción Description	Rotativo Beacons	Halógena H1 H1 Halogen
FA42-4404-231	1	Rotativo 12/24V Incluye lámparas H1 Fijación: Tipo Pincho Flexible Rotating Beacon 12/24V including halogen H1 Fixation: Flexible DIN connector		
FA42-4404-251	1	Rotativo 12/24V Incluye lámparas H1 Fijación: 3 pernos Rotating Beacon 12/24V including halogen H1 Fixation: 3 Bolts		
FA42-4404-261	1	Rotativo 12/24V Incluye lámparas H1 Fijación: 3 pernos + base Magnética Rotating Beacon 12/24V including halogen H1 Fixation: 3 Bolts + Magnetic		
FA42-4404-101	1	Tulipa rotativo Lens Beacon		

Soportes de fijación para Tubo

Pole Mount Bracket







Referencia: Reference-No.	Ud. QTY	Descripción Description	Soporte Fijación Pole Mount Brackets
P50.012.000	1	<p>Soporte fijación, con conector DIN 72 591, para conexión rotativo tipo pincho, 1p</p> <p>Welded fixing bracket for rotating beacons, socket DIN 72 591, 1-pole</p>	
P50.012.100	1	<p>Soporte, 2p</p> <p>Welded fixing bracket dito., 2-poles</p>	
P50.013.000 FA42-4417-001	1	<p>Soporte fijación, con conector DIN 72 591, para conexión rotativo tipo pincho, 1p</p> <p>Screw fixing bracket for rotating beacons, socket DIN 72 591, 1-pole</p>	
P50.013.100	1	<p>Soporte 2p</p> <p>Screw fixing bracket dito., 2-poles</p>	
FA42-4417-041	1	<p>Soporte fijación, con conector DIN 72 591, para conexión rotativo tipo pincho, 1p</p> <p>Pole Mount bracket screw fixing, socket DIN 72 591, 1-pole</p>	
P50.033.000 FA42-4417-011	1	<p>Soporte fijación, con conector DIN 72 591, para conexión rotativo tipo pincho, 1p</p> <p>Straight fixing bracket for rotating beacons, socket DIN 72 591, 1-pole</p>	
P50.034.000 FA42-4417-031	1	<p>Soporte fijación, con conector DIN 72 591, para conexión rotativo tipo pincho, 1p</p> <p>Side fixing bracket for rotating beacons, socket DIN 72 591, 1-pole</p>	
P50.035.000 FA42-4417-061	1	<p>Soporte fijación, con conector DIN 72 591, para conexión rotativo tipo pincho, 1p</p> <p>Fold down fixing bracket for rotating beacons, socket DIN 72 591, 1-pole</p>	
P50.014.000	2	<p>Conector 1p DIN 72 591</p> <p>socket 1-pole, for fixing brackets</p>	 P50.014.000
P50.014.100	2	<p>Conector 2p DIN 72 591</p> <p>socket 2-poles, for fixing brackets</p>	 P50.014.100

Puente Luminoso LED

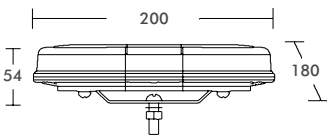
LED Lightbar

Tipo: PRO-MICRO-BAR II



Referencia: Reference-No.	Ud. QTY	Descripción Description	Luces direccion. LED LED Beacons	ECE R65 & R10 According to ECE R65 & R10
P40.515.001	1	<p>Puente luminoso LED PRO-MICRO-BAR II perfil extremadamente bajo, tulipa de Policarbonato, 26 tipos de destellos diferentes, 12/24V, ECE R65, R10 incluidas Cable 3,0m Fijación: 1-Perno</p> <p>LED Lightbar PRO-MICRO-BAR II very low profile, lightbar made of unbreakable polycarbonate, 26 flash patterns, cabled, 12V/24V, ECE R65 & ECE R10 approved, cable 3,0m Fixation: 1 Bolt Fixation</p>		
P40.515.011	1	<p>Puente luminoso LED PRO-MICRO-BAR II color azul</p> <p>LED Lightbar PRO-MICRO-BAR II blue</p>		
P40.515.701	1	<p>Puente luminoso LED PRO-MICRO-BAR II tulipa transparente, ámbar</p> <p>LED Lightbar PRO-MICRO-BAR II clear lens</p>		
P40.515.201	1	<p>Puente luminoso LED PRO-MICRO-BAR II perfil extremadamente bajo, tulipa de Policarbonato, 26 tipos de destellos diferentes, 12/24V, ECE R65, R10 incluidas Cable 3,0m Fijación: Magnética</p> <p>LED Lightbar PRO-MICRO-BAR II very low profile, lightbar made of unbreakable polycarbonate, 26 flash patterns, cabled, 12V/24V, ECE R65 & ECE R10 approved, cable 3,0m Fixation: Magnetic Fixation</p>		
P40.515.211	1	<p>Puente luminoso LED PRO-MICRO-BAR II color azul</p> <p>LED Lightbar PRO-MICRO-BAR II blue</p>		
P40.515.901	1	<p>Puente luminoso LED PRO-MICRO-BAR II tulipa transparente, ámbar</p> <p>LED Lightbar PRO-MICRO-BAR II clear lens</p>		





Puente Luminoso LED

LED Lightbar

Tipo: PRO-COMPACT-BAR

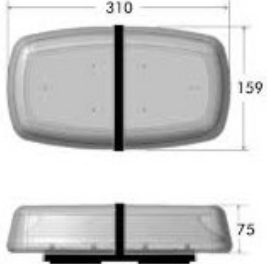

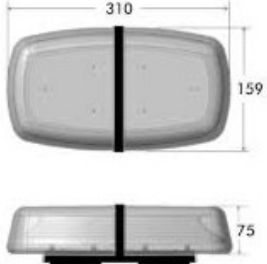
Referencia: Reference-No.	Ud. QTY	Descripción Description	Puente Luminoso Lightbars	Tecnología LED LED Technology
P40.597.201	1	<p>Puente luminoso LED PRO-COMPACT-BAR 12V / 24V, Fijación: Magnética</p> <ul style="list-style-type: none"> - 72 LEDs SMD, alta calidad - Perfil muy bajo, - Base muy resistente y tulipa policarbonato - 8 tipos de destellos diferentes - Larga vida 10.000 horas - ECE R65 & ECE R10, EMC - Incluye interruptor selección de destello y encendido/apagado - Temperatura trabajo -30°/+50° <p>LED Lightbar PRO-COMPACT-BAR</p> <ul style="list-style-type: none"> - 72 high bright SMD - very low profile - Tough & durable ABS base, polycarbonate lens - 8 flash patterns - cabled, 12V/24V - 35W - ECE R65 & ECE R10- EMC - Extreme temperature -30°/+50° 		
P40.597.001	1	<p>Puente luminoso LED PRO-COMPACT-BAR 12V / 24V, Fijación: 2 pernos</p> <ul style="list-style-type: none"> - 72 LEDs SMD, alta calidad - Perfil muy bajo, - Base muy resistente y tulipa policarbonato - 8 tipos de destellos diferentes - Larga vida 10.000 horas - ECE R65 & ECE R10, EMC - Incluye interruptor selección de destello y encendido/apagado - Temperatura trabajo -30°/+50° <p>LED Lightbar PRO-COMPACT-BAR</p> <ul style="list-style-type: none"> - 72 high bright SMD - very low profile - Tough & durable ABS base, polycarbonate lens - 8 flash patterns - cabled, 12V/24V - 35W - ECE R65 & ECE R10- EMC - Extreme temperature -30°/+50° 		

Puente Luminoso LED

LED Lightbar

Tipo: PRO-SUPER-BAR



Referencia. Reference-No.	Ud. QTY	Puente Luminoso LED PRO-SUPER-BAR - 128-200 Led ámbar alta potencia - 12/24V - Diseño ultraplano - Tulipa de policarbonato - R10 & R65, cableado - 10 diferentes tipos de flash - Fijación 4 pernos	LED Lightbar PRO-SUPER-BAR - 12V/24V - Extreme low profile - Mounting brackets, quick fixation - ECE R10 - ECE R65 - 10 patterns - Full unobstructed 360° lighting			
P40.600.001	1	12V 24V	Largo/Length: 980mm	Ancho/Width: 326mm	Alto/Height: 43mm	
P40.601.001	1	12V 24V	Largo/Length: 1200mm	Ancho/Width: 326mm	Alto/Height: 43mm	
P40.602.001	1	12V 24V	Largo/Length: 1420mm	Ancho/Width: 326mm	Alto/Height: 43mm	
P40.603.001	1	12V 24V	Largo/Length: 1640mm	Ancho/Width: 326mm	Alto/Height: 43mm	

Otras medidas por encargo

Further Length on request

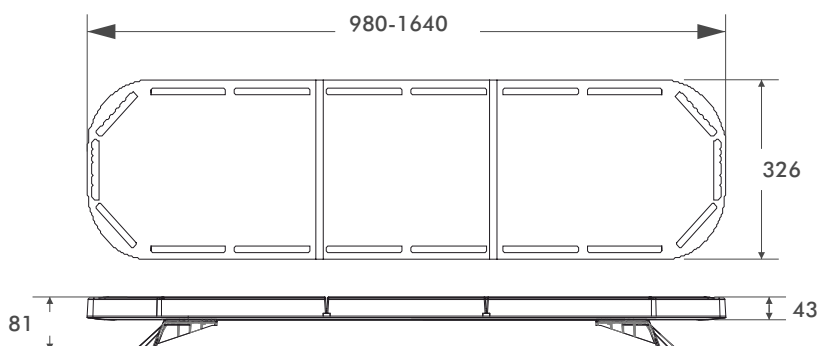

Puente Luminoso LED

LED Lightbar

Tipo: PRO-ROAD-BAR



Referencia. Reference-No.	Ud. QTY	Puente Luminoso LED PRO-ROAD-BAR	LED Lightbar PRO-ROAD-BAR		
		<ul style="list-style-type: none"> - 128 - 432 LED ámbar alta potencia - 12V/24V - Perfil muy bajo - Tulipa policarbonato - Sección central iluminada - Fijación: 4 Pernos - Cableado completo, ECE R65 & ECE R10 	<ul style="list-style-type: none"> - 128 - 432 amber high power LED's - 12V/24V - Very low profile - Polycarbonate moulded lens - opt. opal center section, illuminated - Fixation: 4 Bolts - Complete cabled, ECE R65 & ECE R10 approved 		
40 631 001 	1	12V 24V	Largo/Length: 980mm	Ancho/Width: 326mm	Alto/Height: 43mm
40 631 501 	1	12V 24V	Largo/Length: 980mm	Ancho/Width: 326mm	Alto/Height: 43mm
40 632 001 	1	12V 24V	Largo/Length: 1200mm	Ancho/Width: 326mm	Alto/Height: 43mm
40 632 501 	1	12V 24V	Largo/Length: 1200mm	Ancho/Width: 326mm	Alto/Height: 43mm
40 633 501 	1	12V 24V	Largo/Length: 1420mm	Ancho/Width: 326mm	Alto/Height: 43mm
40 634 501 	1	12V 24V	Largo/Length: 1854mm	Ancho/Width: 326mm	Alto/Height: 43mm

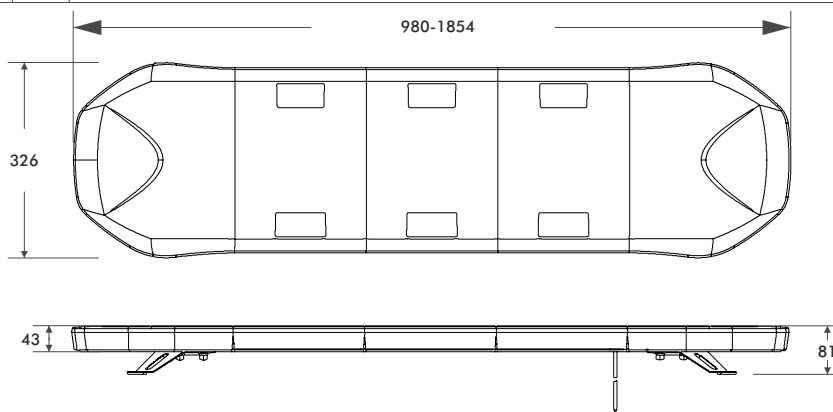

Puente Luminoso LED

LED Lightbar

Tipo: PRO-MULTI-BAR II



Referencia. Reference-No.	Ud. QTY	Puente Luminoso LED PRO-MULTI-BAR II - 108-162 Led ámbar de alta potencia 12/24V - Diseño Aerodinámico y ultraplano - Tulipa Policarbonato - Incluye módulo de control, 29 funciones - Kit de fijación para montaje variable - Cableado, ECE R65 & R10	LED Lightbar PRO-MULTI-BAR II - 108-162 amber high power Led's 12V/24V - Aerodynamic, ultra low profile design - Polycarbonate moulded lens - Onboard Controller included, 29 flash pattern - Fixationkit for variable mount - Complete cabled, ECE R65 & R10 approved			
P40.640.501	1	12V 24V	Largo/Length: 852mm	Ancho/Width: 300mm	Alto/Height: 39mm	
P40.641.501	1	12V 24V	Largo/Length: 1172mm	Ancho/Width: 300mm	Alto/Height: 39mm	
P40.642.501	1	12V 24V	Largo/Length: 1492mm	Ancho/Width: 300mm	Alto/Height: 39mm	
P40.643.501	1	12V 24V	Largo/Length: 1812mm	Ancho/Width: 300mm	Alto/Height: 39mm	

Otras medidas por encargo

Further Length on request

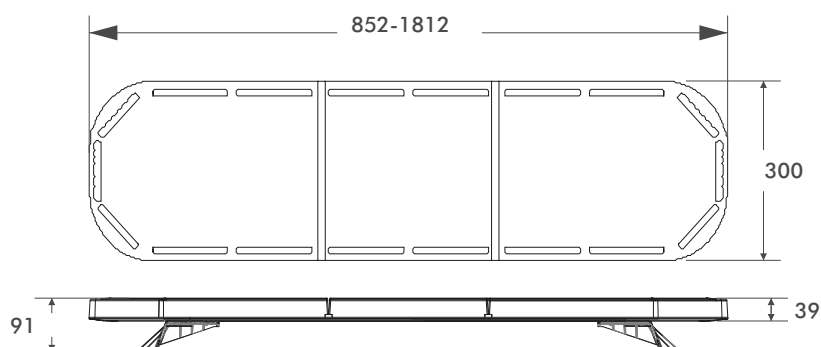

Puente Luminoso LED

LED Lightbar

Tipo: PRO-ROTALED II



Referencia. Reference-No.	Ud. QTY	Puente Luminoso LED PRO-ROTALED II - 2 módulos LED con reflectores de alto rendimiento - 12/24V - Max. consumo 12V-1,4A, 24V-0,8A - Tulipa Policarbonato - Parte central blanca y opaca - Fijación: 4 tornillos incluye amortiguadores - Cable 3m, ECE R65 & ECE R10	LED Lightbar PRO-ROTALED II - 2 Rotating LED modules - Multivoltage 12/24V - max. consumption 12V-1,4A, 24V-0,8A - Polycarbonate moulded lens - Center opal, illuminated - Fixation: 4 Bolts incl. shock absorbers - Cable 3m, ECE R65 & ECE R10 approved					
P40.616.501	1	12V 24V	Largo/Length:	1054mm	Ancho/Width:	220mm	Alto/Height:	82mm
P40.617.501	1	12V 24V	Largo/Length:	1246mm	Ancho/Width:	220mm	Alto/Height:	82mm
P40.621.501	1	12V 24V	Largo/Length:	1585mm	Ancho/Width:	220mm	Alto/Height:	82mm

Otras medidas por encargo

Further Length on request



Referencia. Reference-No.	Ud. QTY	Puente Luminoso LED PRO-ROTALED II - 4 módulos LED con reflectores de alto rendimiento - 12/24V - Max. consumo 12V-1,4A, 24V-0,8A - Tulipa Policarbonato - Parte central blanca y opaca - Fijación: 4 tornillos incluye amortiguadores - Cable 3m, ECE R65 & ECE R10	LED Lightbar PRO-ROTALED II - 4 Rotating LED modules - Multivoltage 12/24V - max. consumption 12V-2,8A, 24V-1,6A - Polycarbonate moulded lens - Center opal, illuminated - Fixation: 4 Bolts incl. shock absorbers - Cable 3m, ECE R65 & ECE R10 approved					
P40.618.501	1	12V 24V	Largo/Length:	1246mm	Ancho/Width:	220mm	Alto/Height:	82mm
P40.619.501	1	12V 24V	Largo/Length:	1585mm	Ancho/Width:	220mm	Alto/Height:	82mm

Otras medidas por encargo

Further Length on request



Puente Luminoso

Lightbar



Referencia. Reference-No.	Ud. QTY	Puente Luminoso AEROLITE - 4 Módulos con reflectores - Alta eficiencia luminosa, óptica de espejo integrada - Parte central blanca y opaca - Tulipa policarbonato - Fijación: 4 tornillos incluye amortiguadores - Cable 3M,	Lightbar AEROLITE - 4 Rotating modules with Free-form optics - Very high light output - Very low profile - Polycarbonate moulded lens - Fixation: 4 Bolts incl. shock absorbers - Cable 3m			
BA6174.200.12V	1	12V	Largo/Length: 1500mm	Ancho/Width: 140mm	Alto/Height: 200mm	
BA6174.200.24V	1	24V	Largo/Length: 1500mm	Ancho/Width: 140mm	Alto/Height: 200mm	

Otras medidas por encargo

Further Length on request



Referencia. Reference-No.	Ud. QTY	Puente Luminoso Xenon AEROLITE - 4 Módulos xenon, - 12/24V, consumo 12V-1.4A, 24V-0.8A - Parte central blanca y opaca - Tulipa policarbonato - Fijación: 4 tornillos incluye amortiguadores - Cable 3M,	Lightbar AEROLITE - 4 Modules xenon - Very high light output - Very low profile - Polycarbonate moulded lens - Fixation: 4 Bolts incl. shock absorbers - Cable 3m			
BA6374.200.12V	1	12V 24V	Largo/Length: 1500mm	Ancho/Width: 140mm	Alto/Height: 200mm	
BA6374.200.24V	1	12V 24V	Largo/Length: 1500mm	Ancho/Width: 140mm	Alto/Height: 200mm	

Otras medidas por encargo



Referencia. Reference-No.	Ud. QTY	Puente Luminoso LED AEROLITE - 2 y 4 Módulos LED - 12/24V, consumo 12V-1.4A, 24V-0.8A - Parte central blanca y opaca - Tulipa policarbonato - Fijación: 4 tornillos incluye amortiguadores - Cable 3M,	Lightbar AEROLITE - 2 or 4 LED Modules - Very high light output - Very low profile - Polycarbonate moulded lens - Fixation: 4 Bolts incl. shock absorbers - Cable 3m			
BA6782.200.LDV 2 Módulos	1	12V 24V	Largo/Length: 1500mm	Ancho/Width: 140mm	Alto/Height: 200mm	
BA6774.200.LDV 4 Módulos	1	12V 24V	Largo/Length: 1500mm	Ancho/Width: 140mm	Alto/Height: 200mm	

Otras medidas por encargo

Further Length on request

Reflectante redondo
Reflectante rectangular
Triángulo reflectante







Reflex Reflectors round
Reflex Reflectors rectangular
Triangle Reflex Reflectors

8.0 - 8.1
8.2 - 8.3
8.4

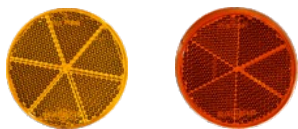
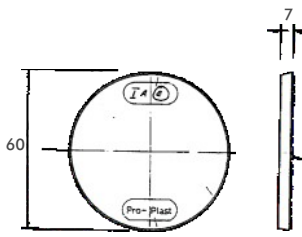

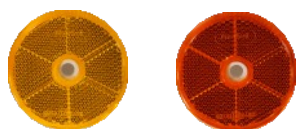
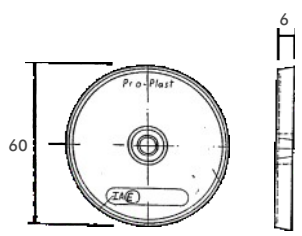
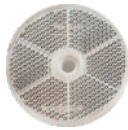
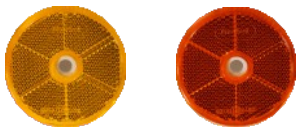
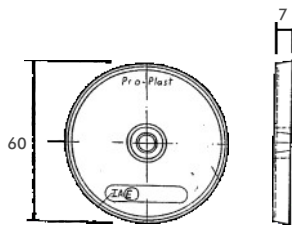

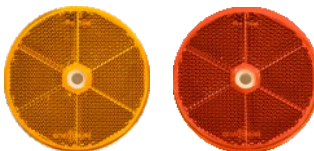
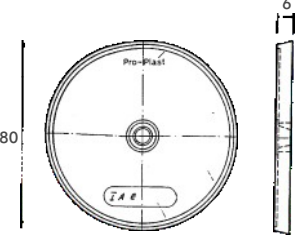

Reflectantes

Reflex Reflector

Referencia. Reference-No.	Ud. QTY	Descripción Description	Reflectantes Reflex Reflectors	
P26.101.101 ámbar / amber	25	Reflectante redondo 60mm, con autoadhesivo posterior		
P26.101.102 rojo / red	25	Reflex reflector round, 60mm with adhesive pad		
P26.101.103 blanco / white	25			
P26.108.001 ámbar / amber	25	Reflectante redondo 60mm, con orificio 6mm para fijación		
P26.108.002 rojo / red	25	Reflex reflector round, 60mm, with hole 6mm		
P26.108.003 blanco / white	25			
P26.108.101 ámbar / amber	25	Reflectante redondo 60mm, con orificio 6mm y autoadhesivo posterior		
P26.108.102 rojo / red	25	Reflex reflector round, 60mm, hole 6mm, with adhesive pad		
P26.108.103 blanco / white	25			
P26.110.001 ámbar / amber	25	Reflectante redondo 80mm, con orificio 6mm para fijación		
P26.110.002 rojo / red	25	Reflex reflector round, 80mm, with hole 6mm		
P26.110.003 blanco / white	25			

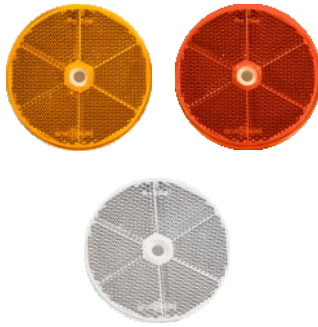
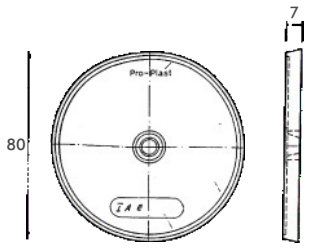

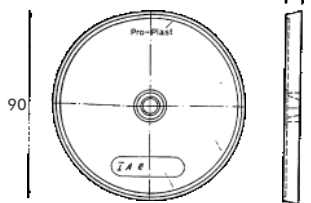
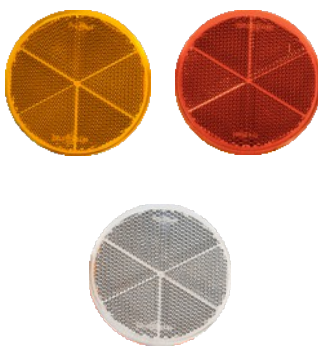
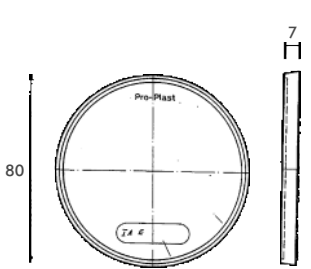

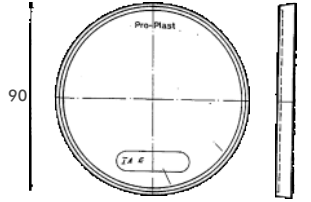





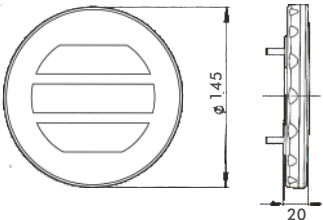

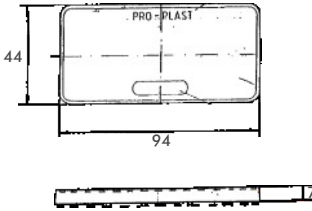
Reflectantes

Reflex Reflector

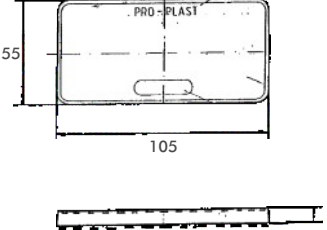
Referencia. Reference-No.	Ud. QTY	Descripción Description	Reflectantes Reflex Reflectors	
P26.110.101 ámbar / amber	25	Reflectante redondo 80mm, con orificio 6mm y autoadhesivo posterior		
P26.110.102 rojo / red	25	Reflex reflector round, 80mm, hole 6mm, with adhesive pad		
P26.110.103 blanco / white	25			
P26.110.202 rojo / red	25	Reflectante redondo 80mm, cobertura de plástico negro 90mm con orificio 6mm		
		Reflex reflector round, outside diameter 90mm, reflex reflector surface 80mm, plastic housing, hole 6mm		
P26.111.101 ámbar / amber	25	Reflectante redondo 80mm, con autoadhesivo posterior		
P26.111.102 rojo / red	25	Reflex reflector round, 80mm, with adhesive pad		
P26.111.103 blanco / white	25			
P26.111.202 rojo / red	25	Reflectante redondo 80mm, cobertura de plástico negro 90mm con perno + tuerca M5		
		Reflex reflector round, outside diameter 90mm, reflex reflector surface 80mm, plastic housing with screw and nut M5		

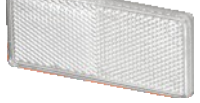

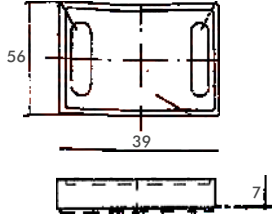

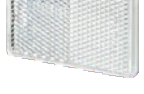





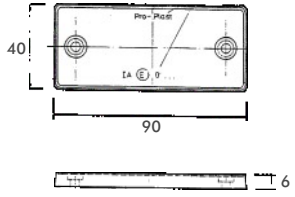

Reflectantes

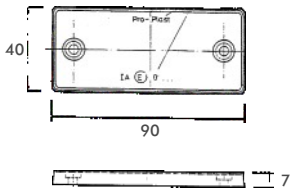
Reflex Reflector

Referencia. Reference-No.	Ud. QTY	Descripción Description	Reflectantes Reflex Reflectors	
P20.105.504 rojo / red	1	Reflectante PRO-T-REFLEX , diseño moderno en cristal transparente, fijación con 2 pernos Reflex Reflector PRO-T-REFLEX , brilliant clear glas optic, fixation with 2 bolts		
P26.103.101 ámbar / amber	25	Reflectante rectangular, 94x44mm con autoadhesivo posterior		
P26.103.102 rojo / red	25	Reflex reflector rectangular, 94x44mm with adhesive pad		
P26.103.103 blanco / white	25			
P26.104.101 ámbar / amber	25	Reflectante rectangular, 105x55mm con autoadhesivo posterior		
P26.104.102 rojo / red	25	Reflex reflector rectangular, 105x55mm with adhesive pad		
P26.104.103 blanco / white	25			
P26.113.101 ámbar / amber	25	Reflectante rectangular, 56x39mm con autoadhesivo posterior		
P26.113.102 rojo / red	25	Reflex reflector rectangular, 56x39mm with adhesive pad		
P26.113.103 blanco / white	25			

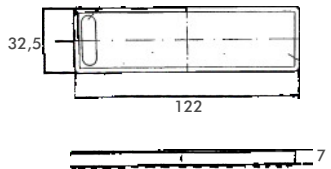

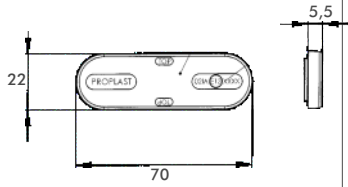

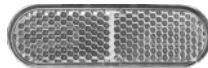

Reflectantes

Reflex Reflector

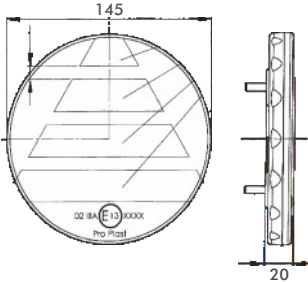
Referencia. Reference-No.	Ud. QTY	Descripción Description	Reflectantes Reflex Reflectors	
P26.109.001 ámbar / amber	25	Reflectante rectangular 90x40mm, 2 orificios 4,2mm		
P26.109.002 rojo / red	25	Reflex reflector rectangular, 90x40mm, 2 holes 4,2mm		
P26.109.003 blanco / white	25			
P26.109.101 ámbar / amber	25	Reflectante rectangular 90x40mm, 2 orificios 4,2mm, con autoadhesivo posterior		
P26.109.102 rojo / red	25	Reflex reflector rectangular, 90x40mm, 2 holes 4,2mm with adhesive pad		
P26.109.103 blanco / white	25			
P26.112.141 ámbar / amber	25	Reflectante rectangular 122x32,5mm con autoadhesivo posterior		
P26.112.142 rojo / red	25	Reflex reflector rectangular, 122x32,5mm with adhesive pad		
P20.017.101 ámbar / amber	2	Reflectante PRO-CAN 70x22mm con autoadhesivo posterior		
P20.017.102 rojo / red	2	Reflex reflector PRO-CAN 70x22mm with adhesive pad		
P20.017.103 blanco / white	2			

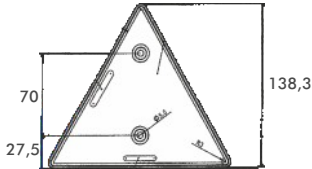
Reflectantes

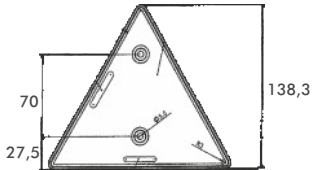
Reflex Reflector

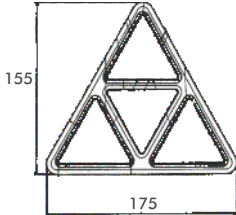
Referencia. Reference-No.	Ud. QTY	Descripción Description	Reflectantes Reflex Reflectors	
P20.105.004	1	<p>Triángulo reflectante PRO-REFLEX, diseño moderno con cristal óptico transparente, con 2 pernos para fijación</p> <p>Triangle Reflex Reflector PRO-REFLEX, brilliant clear glass optic, fixation with 2 bolts</p>		
A15-5400-557	1	<p>Triángulo reflectante con autoadhesivo posterior</p> <p>Triangle Reflex Reflector 2 holes 5,2mm, white housing</p>		
P26.106.003	10	<p>Triángulo reflectante con 2 orificios de 5,2mm, parte posterior blanca</p> <p>Triangle Reflex Reflector 2 holes 5,2mm, white housing</p>		
A15-5400-007	10	<p>Triángulo reflectante con 2 orificios de 5,2mm, parte posterior negra</p> <p>Triangle Reflex Reflector 2 holes 5,2mm, black housing</p>		
P26.107.104	10	<p>Triángulo reflectante con 4 separaciones, placa negra de plástico y perno + tuerca M5 para fijación</p> <p>Triangle Reflex Reflector, solid plastic housing, screws and nuts M5</p>		

Accesorios y cables

- Controlador LED
- Serpentina eléctrica
- Señalización
- Conectores
- Cajas de conexión
- Avisadores acústicos
- Interruptores batería
- Módulos LED
- Amortiguadores

Accessories&cables

- | | | |
|----------------------|------|--------|
| - LED Control Gears | 9.0 | - 9.4 |
| - Electrical Coils | 9.5 | - 9.8 |
| - Marker boards | 9.9 | - 9.10 |
| - Connectors | 9.11 | |
| - Junction Boxes | | |
| - Back Alarm Systems | 9.18 | - 9.19 |
| - Switch Isolator | 9.20 | |
| - LED Modul | 9.20 | |
| - Shock Absorber | 9.20 | |



Controlador LED

LED Control Gear



Referencia. Reference-No.	Ud. QTY	Descripción Description	Controlador LED - Cable sin conector LED Control Gears - cable without connector	
P50.140.024 24V	1	<p>Dispositivo de control central LED PRO-LCG monitoriza la función de luz intermitente y controla las funciones de freno/posición/antiniebla/marcha atrás, Cable 8x1mm², insertados 3.5m lado, lado de salida 1,25 m, ADR, 1 LCG por vehículo dimensiones: 175 x 80 x 22 mm</p> <p>Versión 24VECE R10</p>		
P50.140.012 12V	1	<p>Central LED Control Gear PRO-LCG monitors the dir. indicator function and is checking the funtions stop-tail-fog-reverse light, cable 8x1mm², cable input 3,5m, cable output 1,25m, ADR approved, 1 LCG per vehicle Sizes: L 175 x W 80 x H 22mm 24V Version ECE R10 approved</p>	<p>El PRO-LCG actúa como control y estabilizador del sistema de luces en vehículo de 24V con pilotos de LED. Permite que el sistema de control existente en ta tractora pueda detectar o indicar si una función de señal ha fallado. Además, evita los mensajes de error incorrectos con otras funciones de iluminación, que se deben al bajo consumo de energía en los pilotos LED.</p> <p>The PRO-LCG is used as a control and ballast unit for LED vehicle lights in 12V or 24V onboard electrical systems. It enables the control system already installed in the towing vehicle to detect and display wether a direction indicator function has failed. Furthermore, it prevents incorrect failure signals for other light functions that are conditional on the lower power consumption of the LED lights.</p>	
P50.141.024 24V	1	<p>Dispositivo de control LED PRO-CONTROL, supervisa la señal de luz intermitente cable 1m - 3 x 0.75mm, 1 LCG por lámpara LED</p>		
P50.141.012 12V	1	<p>LED Control Gear PRO-CONTROL monitors the direction indicator function, cable 1m - 3 x 0,75mm², 1 LCG per LED lamp</p>	<p>Dispositivo de control LED PRO-CONTROL es necesario para el ajuste de las características eléctricas de las luces LED y para los requisitos de las tractoras incluyendo cable e instrucciones de montaje.</p> <p>LED Control Gear PRO-CONTROL is needed for the adjustment of the electrical characteristics of the LED lights to the requirements of the tractors, including cable and fitting instruction</p>	
P50.141.312 12V	1	<p>Dispositivo de control LED PRO-CONTROL se utiliza para supervisar la función de Intermitente, las entradas de cable 0.5m banda, salida de cable de 0,5 m, 4 x 0.75mm², 1 LCG por lámpara LED</p> <p>LED Control Gear PRO-CONTROL monitors the direction indicator function, cable input 0,5m, cable output 0,5m, 4 x 0,75mm², 1 LCG per LED lamp</p>		
			<p>Dispositivo de control LED PRO-CONTROL es necesario para el ajuste de las características eléctricas de las luces LED y para los requisitos de las tractoras incluyendo cable e instrucciones de montaje, 12V</p> <p>LED Control Gear PRO-CONTROL is needed for the adjustment of the electrical characteristics of the LED lights to the requirements of the tractors, including cable and fitting instruction, 12V</p>	

Controlador LED

LED Control Gear



Referencia. Reference-No.	Ud. QTY	Descripción Description	Controlador LED - Cable con conector LED Control Gears - cable with connector
P50.140.424 24V - 7-pol.	1	<p>Dispositivo de control LED PRO-LCG monitoriza la función de luz intermitente y control la el freno/posición/antiniebla/marcha atrás, Cable 8x1mm², 3.5m lado de entrada, Lado de salida:</p> <p>24V - 2 líneas con 3,0m 7pol. conector AMP y 0,5 m de cable plano, ECE R10</p> <p>12V - 2 líneas con 1,5m 7pol. conector AMP y Cable plano 0.5m</p> <p>ADR, 1 LCG por vehículo dimensiones: 175 x 80 x 22 mm</p>	<p>24V </p> <p>PRO-LCG 7p AMP</p> <p>12V</p> <p>3500mm</p> <p>PRO-LCG INPUT</p> <p>PRO-LCG OUTPUT</p> <p>1250mm</p> <p>Conector 8p/ 8pol. connector</p> <p>2x0,75mm² 0,5m Flachkabel</p> <p>1500mm - 12V 3000mm - 24V</p> <p>7pol. AMP Stecker/ 7pol. AMP connector</p> <p>50 140 112 - 12V 50 140 224 - 24V</p>
P50.140.412 12V - 7pol.	1	<p>Pre-assembled LED Control Kit PRO-LCG monitors the dir. indicator function and is checking the funtions stop-tail-fog-reverse light, cable 8x1mm², cable input 3,5m, cable output:</p> <p>24V - 2 cable 3,0m with 7pol. AMP connector & flatcable 0,5m, ECE R10 approved</p> <p>12V - 2 cable 1,5m with 7pol. AMP connector & flatcable 0,5m</p> <p>ADR approved, 1 LCG per vehicle Sizes: L 175 x W 80 x H 22mm</p>	

Controlador LED

LED Control Gear



Referencia. Reference-No.	Ud. QTY	Descripción Description	Controlador LED - Cable con conector LED Control Gears - cable with connector
P50.140.212 12V - 5 pol.	1	<p>Dispositivo de control LED PRO-LCG monitoriza la función de luz intermitente y control la el freno/posición/antiniebla/marcha atrás, Cable 8x1mm², 3.5m lado de entrada, Lado de salida:</p> <p>12V - 2 líneas con 1,5m 5p conector y Cable plano 0.5m</p> <p>ADR, 1 LCG por vehículo dimensiones: 175 x.80 x 22 mm</p> <p>Pre-assembled LED Control Kit PRO-LCG monitors the dir. indicator function and is checking the funtions stop-tail-fog-reverse light, cable 8x1mm², cable input 3,5m, cable output + 2 cables 1,5m with 5-pol. connector & flatcable 0,5m</p> <p>ADR approved, 1 LCG per vehicle Sizes: L 175 x W 80 x H 22mm</p>	<p>PRO-LCG 12V 5p conector</p> <p>3500mm</p> <p>1250mm</p> <p>8pol. Stecker/ 8pol. connector</p> <p>2x0,75mm² 0,5m Flachkabel</p> <p>2x0,75mm² 0,5m Flachkabel</p> <p>1500mm</p> <p>1500mm</p> <p>5pol. Bajonettstecker/ 5pol. connector</p> <p>NSL</p> <p>RFL</p> <p>50 140 212 - 12V</p>
P50.141.212 12V	1	<p>Dispositivo de control LED PRO-CONTROL, supervisa la señal de luz intermitente cable1m - 3 x 0.75mm, conector 5p, 1 LCG por lámpara LED</p> <p>Pre-assembled LED Control Kit (LCG) PRO-CONTROL monitors the direction indicator function, cable 0,3m, 5-poles connector, 1 LCG per LED lamp</p>	<p>PRO-CONTROL 12V</p> <p>300mm</p> <p>Conector 5p macho/ Connector 5-poles male</p> <p>Conector 5p hembra/ Connector 5-poles female</p>

Controlador LED

LED Control Gear



Referencia. Reference-No.	Ud QTY	Descripción Description	Controlador LED LED Contro Gears	
P50.139.024 24V	1	Dispositivo de control LED PRO-LOAD controla las funciones de 21W, Freno-Intermitente-Niebla-Marcha Atrás, cable 1,0m, 1 LCG por función y luz LED LED Control Gear PRO-LOAD is checking the 21W functions like stop-dir.indicator-fog-reversing light, cable 1,0m, 1 LCG per function and LED lamp		Para aplicación en vehículos con sistema de ordenador a bordo, si sustituye las lámparas por módulos LED, el LCG eliminará el mensaje de error For the application in vehicles with onboard computer. If changing from bulbs to LED modules, the LCG switch of the failure message.
P50.139.012 12V	1	Dispositivo de control LED PRO-LOAD controla las funciones de 21W, Freno-Intermitente-Niebla-Marcha Atrás, cable 1,0m, 1 LCG por función y luz LED LED Control Gear PRO-LOAD is checking the 21W functions like stop-dir.indicator-fog-reversing light, cable 1,0m, 1 LCG per function and LED lamp		Para aplicación en vehículos con sistema de ordenador a bordo, si sustituye las lámparas por módulos LED, el LCG eliminará el mensaje de error For the application in vehicles with onboard computer. If changing from bulbs to LED modules, the LCG switch of the failure message.
P50.141. 500 12/24V	1	Dispositivo de control LED PRO-CONTROL controla la función de intermitencia, Cable de 1m. - 3 x 0,75mm 1,0m, 1 LCG por función y luz LED LED Control Gear PRO-CONTROL monitors the direction indicator function, cable 1m - 3 x 0,75mm ² , 1 LCG per LED lamp		
P50.125. 524 24V	1	Dispositivo de control LED para las funciones de posición, cable 1,0m 1 LCG por LED LED Control Gear is checking the tail light function, cable 1,0m, 1 LCG per LED lamp		
P50.125. 512 12V	1	Dispositivo de control LED para las funciones de posición, cable 1,0m 1 LCG por LED LED Control Gear is checking the tail light function, cable 1,0m, 1 LCG per LED lamp		Para aplicación en vehículos con sistema de ordenador a bordo, si sustituye las lámparas por módulos LED, el LCG eliminará el mensaje de error For the application in vehicles with onboard computer. If changing from bulbs to LED modules, the LCG switch of the failure message.









Controlador LED

LED Control Gear

Referencia. Reference-No.	Ud QTY	Descripción Description	Controlador LED LED Contro Gears	
A75-0300-001 24V	1	<p>Dispositivo de control LED LCG-ASS2 para las funciones de freno/intermitente/posición cable 0,5m con conector ASS2, 24V, 1 LCG por lado de vehículo</p> <p>LED Control Gear LCG-ASS2 monitors the stop-tail-direction indicator function, cable 0,5m with ASS2 connector, 24V, 1 LCG per vehicle side needed</p>	 <p>Dispositivo control LED LCG-ASS2, necesario para el ajuste de las funciones LED, de acuerdo a los requerimientos de los vehículos 24V, incluye cableado e instalación completa</p> <p>LED Control Gear LCG-ASS2, needed for the adjustment of the electrical characteristics of the LED lights to the requirements of the tractors, including cable and fitting instruction, 24V</p>	
A13-5626-971	1	<p>Kit conector ASS2 7p para LCG ASS2</p> <p>Connector ASS2, 7-poles for LCG-ASS2 female, Aspöck-Nr. 13-5626-971</p>	 <p>A13-5626-971</p>	
A13- 5625-861	1	<p>Kit conector ASS2 7p para LCG ASS2</p> <p>Connector ASS2, 7-poles for LCG ASS2 male, Aspöck-Nr. 13-5625-861</p>	 <p>A13-5625-861</p>	

Accesorios / Placas Señalización

Accessories / Marker Boards

Referencia. Reference-No.	Ud QTY	Descripción Description	Placas Señalización Marker Boards
BI90068	1	Placa de señalización mercancía sobresaliente V20 medidas: 500 x 500mm	
A51.362.00	1	Placa de señalización mercancía sobresaliente y reflectante según reglamento ECE 104 medidas: 423 x 423mm	
A99-9001-001	1	Placa señalización REG.70/1 para vehículo largo, aluminio, medidas: 1132 x 197 x 1mm	
A99-9001-002	1	Kit 2 unidades placas señalización REG.70/1 para vehículo largo, aluminio, medidas: 566 x 197 x 1mm	
A99-9000-001/1	1	Adhesivo señalización REG.70 para vehículo largo, medidas: 1130 x 200 x 2mm	
A99-9000-002/1	1	Kit adhesivos señalización REG.70 para vehículo largo, medidas: 565 x 200 x 2mm	
A99-9000-003	1	Kit 2 unidades placas señalización para vehículo pesado, aluminio, medidas: 565 x 130 x 1mm	
A99-9000-004	1	Placa señalización para vehículo pesado, aluminio, medidas: 1130 x 130 x 1mm	

Accesorios y Bandas Reflectantes

Accesories/Retro-reflective markings

Referencia. Reference-No.	Ud QTY	Descripción Description	Bandas Reflectantes Retro-reflective markings
F92-V6700B	1	Banda reflectante Avery ECE 104 blanca, rollo 50m.	
F92-V6701B	1	Banda reflectante Avery ECE 104 amarilla, rollo 50m.	
F92-V6722B	1	Banda reflectante Avery ECE 104 roja, rollo 50m.	
F92-V6790	1	Banda reflectante Avery ECE 104 blanca, cortada 5cm, rollo 50m.	
F92-V6791	1	Banda reflectante Avery ECE 104 amarilla, cortada 5cm, rollo 50m.	
F92-V6792	1	Banda reflectante Avery ECE 104 roja, cortada 5cm, rollo 50m.	
A99-9000-014	1	Placa TIR, medidas 400x250x1mm	
A99-9000-015	1	Placa plegable vertical TIR, medidas 400x250x1mm	
A99-9000-016	1	Placa mercancías peligrosas plegable VERTICAL V11 Nivel 2 con reflectante tipo panel de abeja, ADR, medidas 400x300x1mm	
A99-9000-017	1	Placa mercancías peligrosas plegable HORIZONTAL V11 Nivel 2 con reflectante tipo panel de abeja, ADR, medidas 400x300x1mm	

Accesorios

Accessories

Referencia. Reference-No.	Ud QTY	Descripción Description	Accesorios Accessories
S60.000.000	1	Portaextintor 6-9 kilos con 1 cierre acorde a la normativa ISO4892-3 / ISO3795,	
S60.000.001	1	Portaextintor 6-9 kilos con 2 cierres acorde a la normativa ISO4892-3 / ISO3795	
S60.000.002	1	Portaextintor 6 kilos	
S60.000.003	1	Calzo acorde a la normativa DIN 76051-G46Z	
S60.000.004	1	Caja de herramientas para remolque, capacidad 50L	
S60.000.005	1	Caja de herramientas para remolque, capacidad 80L	
S60.000.006	1	Caja de herramientas para remolque, capacidad 110L	

Serpentinas Eléctricas

Electrical Coils

Referencia. Reference-No.	Ud QTY	Descripción Description	Serpentinas Eléctricas Electricas Coils
S53-0001-040	1	Serpentina eléctrica ABS ADR/GGVS con 2 conectores de 5p, acorde con la normativa ISO 7638, largo total 4m.. 2x4mm + 3x1.5mm	
S53-0002-040 K53-0002-040	1 1	Serpentina eléctrica EBS ADR/GGVS con 2 conectores de 7p, acorde con la normativa ISO 7638, largo total 4m.. 2x4mm + 5x1.5mm	
S53-0067-040 K53-0067-040	1 1	Serpentina eléctrica 15 POLOS ADR/GGVS con 2 conectores de 15p, acorde con la normativa ISO 12098, largo total 4m.. 3x2.5mm + 12x1.5mm	
S53-2424-040 K53-2424-040	1 1	Serpentina eléctrica 15POLOS DOBLE ADR/GGVS con los siguientes conectores: 1 conector PVC 15p ISO 12098 2 conectores aluminio : Tipo N ISO 1185 Tipo S ISO 3731 incluye muelle/gancho de seguridad, largo total 4m..	
K53-2424-041	1	Serpentina eléctrica 15POLOS DOBLE ADR/GGVS con los siguientes conectores: 1 conector PVC 15p ISO 12098 2 conectores PVC : Tipo N ISO 1185 Tipo S ISO 3731 largo total 4m..	

- Otras medidas o versiones, consultar

Serpentinas Eléctricas

Electrical Coils

Referencia. Reference-No.	Ud QTY	Descripción Description	Serpentinas Eléctricas Electricas Coils
S56-0001-040 K56-0001-040	1 1	Serpentina eléctrica tipo N con 2 conectores de aluminio 7p acorde con la normativa ISO 1185, largo total 4m.. 6x1mm + 1x1.5mm, incluye muelle/gancho de seguridad	
S57-0001-040 K57-0001-040	1 1	Serpentina eléctrica tipo S con 2 conectores de aluminio 7p, acorde con la normativa ISO 3731, largo total 4m.. 6x1mm + 1x1.5mm, incluye muelle/gancho de seguridad	
K56-0001-040/P	1	Serpentina eléctrica tipo N con 2 conectores de PVC inyectado 7p acorde con la normativa ISO 1185, largo total 4m.. 6x1mm + 1x1.5mm,	
K57-0001-040/P	1	Serpentina eléctrica tipo S con 2 conectores de PVC inyectado 7p acorde con la normativa ISO 3731, largo total 4m.. 6x1mm + 1x1.5mm,	
S13-3270-007	1	Conector macho 15p + con 2 conectores de 7p	

- Otras medidas o versiones, consultar

Bases y Conectores

Plug and Sockets

Referencia. Reference-No.	Ud QTY	Descripción Description	Bases y Conectores Plug and sockets
S13-0000-001/5T	1	Conector ABS sujeción clavija con tornillos	
S13-0000-001/7T	1	Conector EBS sujeción clavija con tornillos	
S13-0000-002/15T	1	Conector 15p sujeción clavija con tornillos	
S13-0000-001/5	1	Conector ABS sujeción clavija: soldar	
S13-0000-001/7	1	Conector EBS sujeción clavija: soldar	
S13-0000-002/15	1	Conector 15p sujeción clavija: soldar	
S13-0000-001	1	Conector ABS sin clavijas	
S13-0000-001	1	Conector EBS sin clavijas	
S13-0000-002	1	Conector 15p sin clavijas	
S13-1000-001/5T	1	Conector ABS sujeción clavija con tornillos	
S13-1000-001/7T	1	Conector EBS sujeción clavija con tornillos	
S13-1000-002/15T	1	Conector 15p sujeción clavija con tornillos	
S13-1000-001/5	1	Conector ABS sujeción clavija: soldar	
S13-1000-001/7	1	Conector EBS sujeción clavija: soldar	
S13-1000-002/15	1	Conector 15p sujeción clavija: soldar	
S13-1000-001	1	Conector ABS sin clavijas	
S13-1000-001	1	Conector EBS sin clavijas	
S13-1000-002	1	Conector 15p sin clavijas	
S14-4630-000	1	Pin hembra para conector macho de 1,5 - 2,5mm	
S14-4630-001	1	Pin hembra para conector macho de 4 - 6mm	
S14-4630-017	1	Pin macho para base hembra 1,5 - 2,5mm	
S14-4630-027	1	Pin macho para base hembra 4 - 6mm	

- Las referencias que empiezan por K en las bases y conectores son todas con tornillo de fijación.

Bases y Conectores

Plug and Sockets

Referencia. Reference-No.	Ud QTY	Descripción Description	Bases y Conectores Plug and sockets
S13-3093-507	1	Conector macho PVC 3p ISO 9680, 12V	
S13-3193-507	1	Base hembra PVC 3p ISO 9680, 12V	
S13-3282-007	1	Adaptador 7p a 13p de PVC ISO 1724 + ISO 11446, 12V	
SE4002	1	Conector macho tipo NATO ISO 96917	
SE4702	1	Conector base tipo NATO ISO 96917	
SE4220F40	1	Serpentina tipo NATO ISO 96917, Sección 35mm, diámetro interno 40/52mm, extensión 4/5.4m	
SE4220F60	1	Serpentina tipo NATO ISO 96917, Sección 35mm, diámetro interno 67/84mm, extensión 6/8.1m	

Bases y Conectores

Plug and Sockets

Referencia. Reference-No.	Ud QTY	Descripción Description	Bases y Conectores Plug and sockets
S13-3020-001 K13-3020-001	1 1	Conector 7p tipo N de aluminio ISO 1185 - 24V	
S13-3025-001 K13-3025-001	1 1	Conector 7p tipo S de aluminio ISO 3731 - 24V	
S13-3128-067 K13-3128-067	1 1	Base 7p tipo N de aluminio ISO 1185 - 24V	
S13-3129-067 K13-3129-067	1 1	Base 7p tipo S de aluminio ISO 3731 - 24V	
S13-3010-007 K13-3010-007	1 1	Conector 7p de aluminio ISO 1724 - 12V	
S13-3115-007 K13-3115-007	1 1	Base 7p de aluminio ISO 1724 - 12V	
S13-3000-007 K13-3000-007	1 1	Conector 7p de PVC ISO 1724 - 12V	
S13-3105-007 K13-3105-007	1 1	Base 7p de PVC ISO 1724 - 12V	

Accesorios /Conectores

Accessories/Connectors

Tipo: AMP SUPER SEAL / DEUTSCH DT

Referencia. Reference-No.	Ud QTY	Descripción Description	Conectores Connectors	
P50.079.000	1	Kit conector 2p AMP SUPER SEAL Connector Set 2-poles, AMP SUPER SEAL		
P50.079.900	1	Kit conector 2p tipo T AMP SUPER SEAL T-Connector 2-poles, AMP SUPER SEAL	P50.079.000	P50.079.900
P50.079.100	1	Kit conector 2p macho AMP SUPER SEAL Connector 2-poles male, AMP SUPER SEAL		
P50.079.200	1	Kit conector 2p hembra AMP SUPER SEAL Connector 2-poles female, AMP SUPER SEAL	P50.079.100	P50.079.200
P50.079.300	1	Kit conector 3p macho AMP SUPER SEAL Connector 3-poles male, AMP SUPER SEAL		
P50.079.400	1	Kit conector 3p hembra AMP SUPER SEAL Connector 3-poles female, AMP SUPER SEAL	P50.079.300	P50.079.400
P50.079.500	1	Kit conector 4p macho AMP SUPER SEAL Connector 4-poles male, AMP SUPER SEAL		
P50.079.600	1	Kit conector 4p hembra AMP SUPER SEAL Connector 4-poles female, AMP SUPER SEAL	P50.079.500	P50.079.600
P50.003.100	1	Kit conector 2p macho DEUTSCH DT Connector 2-poles male, DEUTSCH DT		
P50.003.200	1	Kit conector 2p hembra DEUTSCH DT Connector 2-poles female, DEUTSCH DT	P50.003.100	P50.003.200
P50.003.300	1	Kit conector 3p macho DEUTSCH DT Connector 3-poles male, DEUTSCH DT		
P50.003.500	1	Kit conector 3p hembra DEUTSCH DT Connector 3-poles female, DEUTSCH DT	P50.003.300	P50.003.500
P50.003.400	1	Kit conector 4p macho DEUTSCH DT Connector 4-poles male, DEUTSCH DT		
P50.003.600	1	Kit conector 4p hembra DEUTSCH DT Connector 4-poles female, DEUTSCH DT	P50.003.400	P50.003.600

Accesorios /Conectores

Accessories/Connectors

Tipo: UNIVERSAL / ASPÖCK

Referencia. Reference-No.	Ud QTY	Descripción Description	Conectores Connectors	
P50.071.000	1	Kit conector 7p, acodado 90° para M.A.N. Connector 8-poles, 90° connector for M.A.N.		
A15-7002-024	1	Kit conector 7p para M.A.N, MB, SCANIA, VOLVO, RENAULT, DAF, NISSAN Connector 7-poles for M.A.N., MB, SCANIA, VOLVO, RENAULT, DAF, NISSAN		
A15-7002-034	1	Kit conector 7p AMP macho Connector 7-poles, AMP male		Para pilotos traseros For Rear Combination Lamps
P50.071.200	1	Kit conector 8p, recto para SCAN-Box Connector 8-poles, straight connector for SCAN-Box		
A13-0536-044	1	Kit conector 5p macho, Aspöck Connector 5-poles, male Aspöck-No. 13-0536-044		Para pilotos traseros For Rear Combination Lamps
A13-0546-004	1	Kit conector 5p hembra, Aspöck Connector 5-poles, female Aspöck-No. 13-0546-004		
A13-5626-941	1	Kit conector ASS1/ASS2 7p Aspöck Repairkit Connector ASS1/ASS2 7-poles, Aspöck-No. 13-5626-941		
A13-5626-951	1	Kit conector ASS1/ASS2 7p Aspöck Repairkit Connector ASS1/ASS2 7-poles, Aspöck-No. 13-5626-951		

Accesorios /Conectores

Accessories/Connectors









Tipo: UNIVERSAL / ASPÖCK

Referencia. Reference-No.	Ud QTY	Descripción Description	Conectores Connectors	
P50.059.100	1	Kit conector 8p, macho Connector 8-poles, male		
P50.059.200	1	Kit conector 8p, hembra Connector 8-poles, female		
			50 059 100	50 059 200
P50.068.100	1	Kit conector 7p, HDSCS macho Connector 7-poles, HDSCS male		
P50.059.200	1	Kit conector 7p, hembra Connector 7-poles, HDSCS female		
			50 068 100	50 068 200
P50.068.000	1	Kit conector 8p, HDSCS hembra con funda retráctil Connector 8-poles, HDSCS female with heat shrink tube		
			50 068 000	
P50.071.100	1	Kit conector 7p, AMP hembra Connector 7-poles, female		
P50.071.300	1	Kit conector 7p, AMP macho Connector 7-poles, AMP male		
			50 071 100	50 071 300
P50.071.000	1	Kit conector 8p, 90° para MAN Connector 8-poles, 90° for MAN		
P50.071.200	1	Kit conector 8p, para SCAN-Box Connector 8-poles, straight connector for SCAN-Box		
			50 071 000	50 071 200

Accesorios /Conectores

Accessories/Connectors

Tipo: ASPÖCK

Referencia. Reference-No.	Ud QTY	Descripción Description	Conectores Connectors
A13-5626-284	1	Kit conector ASS1 2p Connector ASS1 2-poles, Aspöck-No. 13-5626-284	
A13-1722-001	1	Kit conector ASS3 17p hembra Repairkit ASS3, 17-poles, female, Aspöck-Nr. 13-1722-001	
A13-1732-001	1	Kit conector ASS3 17p macho Repairkit ASS3, 17-poles, male, Aspöck-Nr. 13-1732-001	
A13-5626-331	1	Kit conector ASS1 2p hembra Repairkit ASS1, 2-poles, female, Aspöck-Nr. 13-5626-331	
A13-5625-361	1	Kit conector ASS1 2p macho Repairkit ASS1, 2-poles, male, Aspöck-Nr. 13-5625-361	
A15-5624-031	1	Kit conector ASS2, 2p hembra Repairkit ASSt, 2-poles, female, Aspöck-Nr. 15-5624-031	
A15-0281-021	1	Kit conector ASS2, 2p macho Repairkit ASS2, 2-poles, male, Aspöck-Nr. 15-0281-021	
A13-1520-051	1	Kit conector 15p hembra Repairkit Bayonett, 15-poles, female, Aspöck-Nr. 13-1520-051	
A13-1530-101	1	Kit conector 15p macho Repairkit, 15-poles, male, Aspöck-Nr. 13-1530-101	





Accesorios /Cajas de Conexión

Accessories/Junction Box

Referencia. Reference-No.	Ud QTY	Descripción Description	Cajas de Conexiones Junction Box	
P50.016.000	1	<p>Caja conexiones 12p a prueba de agua</p> <p>Junction Box 12-poles, waterproofed</p>		
A76-5100-007	1	<p>Caja conexiones doble, Aspöck sistema ASS1, 14 salidas con gomas de colores para los diferentes diámetros de cable, IP68</p> <p>Doble Junction Box Aspöck ASS1, IP 68 approved</p>		<p>Especificaciones técnicas Specification</p> <ul style="list-style-type: none"> - Cableado y numeración de acuerdo al ISO12098 Cables and numbers according to ISO 12098 - Salidas con gomas de colores para los diferentes diámetros de cable Cover with coloured boots for different cable diameter - Todos los terminales/pins son 6.3mm, AMP All terminals are 6,3mm AMP faston
A76-5100-047	1	<p>Caja conexiones sencilla, Aspöck sistema ASS1, 8 salidas con gomas de colores para los diferentes diámetros de cable, IP68</p> <p>Doble Junction Box Aspöck ASS1, IP 68 approved</p>		<p>Especificaciones técnicas Specification</p> <ul style="list-style-type: none"> - Cableado y numeración de acuerdo al ISO12098 Cables and numbers according to ISO 12098 - Salidas con gomas de colores para los diferentes diámetros de cable Cover with coloured boots for different cable diameter - Todos los terminales/pins son 6.3mm, AMP All terminals are 6,3mm AMP faston
A76-7001-007	1	<p>Caja conexiones Aspöck e conectores 24V, precableada para multifunciones:</p> <ul style="list-style-type: none"> - Conector DIN/ISO 1185 - Conector DIN/ISO 3731 - Conector DIN/ISO 7257, 15p <p>3-Socket Junction Box 24V, pre-assembled multifunction-housing with:</p> <ul style="list-style-type: none"> - Socket DIN/ISO 1185 - Socket DIN/ISO 3731 - Socket DIN/ISO 72570 - 15-poles 		<p>Especificaciones técnicas Specification</p> <ul style="list-style-type: none"> - Cableado y numeración de acuerdo al ISO12098 Cables and numbers according to ISO 12098 - Salidas con gomas de colores para los diferentes diámetros de cable Cover with coloured boots for different cable diameter - Todos los terminales/pins son 6.3mm, AMP All terminals are 6,3mm AMP faston

Accesorios/Cable

Accessories/Cable

Referencia Reference-No.	Ud QTY	Descripción Description	Cables Cables	
P50.044.081	1	Cable espiral con conector DEUTSCH DT, largo total 7,5m Spiral cable with DEUTSCH DT connector, extends to 7,5m		
P50.105.005	1	Cable 0,5m con conector AMP Superseal Cable 0,5m with AMP Superseal connector		
P50.105.015	1	Cable 1,5m con conector AMP Superseal Cable 1,5m with AMP Superseal connector		
P50.138.000	1	Cable para piloto posición LED SCANIA con conector 2p, cable 0,3m Cable for LED Position Lamp SCANIA with 2-pole connector, cable 0,3m		











Accesorios/Cable P&R

Accessories/Cable P&R

Referencia Reference-No.	Ud QTY	Descripción Description	Cable P&R Cable P&R	
A68-5000-057	1	Cable extensible 0,25m con conector Aspöck P&R Cable PUR 0,25m with Aspöck P&R connector		
A68-5000-017	1	Cable extensible 0,5m con conector Aspöck P&R Cable PUR 0,5m with Aspöck P&R connector		
A68-5000-027	1	Cable extensible 1m con conector Aspöck P&R Cable PUR 1,0m with Aspöck P&R connector		
A68-5000-037	1	Cable extensible 1,5m con conector Aspöck P&R Cable PUR 1,5m with Aspöck P&R connector		
A68-5000-077	1	Cable extensible 1,75m con conector Aspöck P&R Cable PUR 1,75m with Aspöck P&R connector		
A68-5000-047	1	Cable extensible 2.0m con conector Aspöck P&R Cable PUR 2,0m with Aspöck P&R connector		
A68-5000-127	1	Cable extensible 2,5m con conector Aspöck P&R Cable PUR 2,5m with Aspöck P&R connector		
A68-5000-067	1	Cable extensible 3,0m con conector Aspöck P&R Cable PUR 3,0m with Aspöck P&R connector		
A68-5000-587	1	Cable extensible 5m con conector Aspöck P&R Cable PUR 5,0m with Aspöck P&R connector		
A15-5971-007	10	Grapa gris para conector Aspöck P&R Caps for Aspöck P&R connector, grey		

Accesorios/Retro-Alarma

Accessories/Back Alarm System

Referencia Reference-No.	Ud QTY	Descripción Description	Retro-Alarma Cables	
A75-0000-007	1	<p>Retro-alarma 24V, incluye cable 1,20m, con conector ASS1 2p, IP 68</p> <p>Montaje:</p> <ul style="list-style-type: none"> - En la caja del piloto - En el chasis del vehículo <p>Back Alarm System 24V incl. Cable 1,20m, IP 68 approved</p> <p>Fixation:</p> <ul style="list-style-type: none"> - Direct at the rear lamp housing - At the chassis 		<p>Especificaciones Técnicas Specification</p> <ul style="list-style-type: none"> - 24V - Señal acústica 98db - 2400 Hz - Orificio para montaje 28mm 
A75-0001-007	1	<p>Retro-alarma 24V, incluye cable 1,2m, con conector ASS1 2p, IP 68</p> <p>Montaje:</p> <ul style="list-style-type: none"> - En la caja del piloto - En el chasis del vehículo <p>Back Alarm System 24V incl. Cable 4m, IP 68 approved</p> <p>Fixation:</p> <ul style="list-style-type: none"> - Direct at the rear lamp housing - At the chassis 		<ul style="list-style-type: none"> - 24V - Señal acústica 98db - 2400 Hz - Orificio para montaje 28mm 
A75-0018-007	1	<p>Retro-alarma 24V, incluye cable 4m, con conector ASS3 2p, IP 68</p> <p>Montaje:</p> <p>Back Alarm System 24V incl. Cable 1,20m, IP 68 approved</p> <p>Fixation:</p>		<ul style="list-style-type: none"> - 24V - Señal acústica 98db - 2400 Hz - Orificio para montaje 28mm 
A75-0019-007	1	<p>Retro-alarma 24V, incluye cable 1,2m, con conector ASS2 2p, IP 68</p> <p>Montaje:</p> <p>Back Alarm System 24V incl. Cable 1,20m, IP 68 approved</p> <p>Fixation:</p>		<ul style="list-style-type: none"> - 24V - Señal acústica 98db - 2400 Hz - Orificio para montaje 28mm 
A12-3922-004	1	<p>Retro-alarma 24V empotrable ADR</p> <p>Montaje:</p> <ul style="list-style-type: none"> - En el interior del piloto <p>Back Alarm System 24V recessed version, ADR approved</p> <p>Fixation:</p> <ul style="list-style-type: none"> - Direct in the rear lamp housing 		<p>Especificaciones Técnicas Specification</p> <ul style="list-style-type: none"> - 24V - 70mA bei 24V - 92 dBA - 3300-500 Hz - 20 gr. - 25 x 25 x 25mm 

Accesorios/Retro-Alarma

Accessories/Back Alarm System

Referencia Reference-No.	Ud QTY	Descripción Description	Retro-Alarma Cables	
P50.090.300	1	<p>Retro-alarma PRO-NIGHT 12/24V para vehículos de medio tonelaje Montaje: - Superficie</p> <p>Back Alarm System PRO NIGHT 12/24V for medium duty application Fixation: - Pendant version</p>		<p>Especificaciones Técnicas Specification</p> <ul style="list-style-type: none"> - 12/24V - 97 dBA - -40° bis +85° - A prueba de agua - 300 gr. - 102x71x41mm
P50.090.400	1	<p>Retro-alarma PRO-MEDIALARM 12/24V para vehículos de medio tonelaje Montaje: - Superficie</p> <p>Back Alarm System PRO MEDIALARM 12/24V for medium duty application Fixation: - Pendant version</p>		<p>Especificaciones Técnicas Specification</p> <ul style="list-style-type: none"> - 12/24V - 97 dBA - -40° bis +85° - A prueba de agua - 300 gr. - 102x71x41mm
P50.090.500	1	<p>Retro-alarma PRO-SMARTALARM 12/24V autoregulable Montaje: - Superficie</p> <p>Back Alarm System PRO SMARTALARM 12/24V self adjusting reversing alarm Fixation: - Pendant version</p>		<p>Especificaciones Técnicas Specification</p> <ul style="list-style-type: none"> - 12/24V - 82-102 dBA - -40° bis +85° - A prueba de agua - 300 gr. - 102x71x41mm
P50.090.800	1	<p>Retro-alarma PRO-INDUALARM 12-80V para maquinaria de obras públicas Montaje: - Superficie</p> <p>Back Alarm System PRO INDUALARM 12-80V for forklift applications Fixation: - Pendant version</p>		<p>Especificaciones Técnicas Specification</p> <ul style="list-style-type: none"> - 12-80V - 87 dBA - -40° bis +85° - A prueba de agua - 300 gr. - 102x71x41mm





Accesorios/Retro-Alarma

Accessories/Back Alarm System

Referencia Reference-No.	Ud QTY	Descripción Description	Retro-Alarma Cables	
P50.090.450	1	Retro-alarma PRO-ALARM 97Db. 10/80V cable 0,4m IP 67, R10 Back Alarm System PRO-ALARM 97dBA 10/80V, cable 0,4m, waterproof casted, IP67, ECE R10 approved		Especificaciones Técnicas Specification - 12/24V - 97-0 dBA - -40° bis +85° - A prueba de agua - 300 gr. - 102x71x41mm
P50.090.750	1	Avisador Acústico PRO-ALARM Carcasa: Plástico Conexión: 0,4m open end Voltaje: 10-80 Volt Protección: IP67 Homolog.: EMV geprüft Potencia: 102dBA Función: Pitido Back Alarm System PRO-ALARM Housing: Plastic Cable: 0,4m open end Voltage: 10-80 Volt Protection: IP67 Homologation: EMC approved Power: 102dBA Function: Beep sound		Especificaciones Técnicas Specification - 12/24V - 97 dBA - -40° bis +85° - A prueba de agua - 300 gr. - 102x71x41mm
P50.090.850	1	Retro-alarma PRO-ALARM 92Db. 10/80V cable 0,4m IP 67, R10 Back Alarm System PRO-ALARM 92DBA 10/80V, cable 0,4m, waterproof casted, IP67, ECE R10 approved		Especificaciones Técnicas Specification - 12/24V - 82-102 dBA - -40° bis +85° - A prueba de agua - 300 gr. - 102x71x41mm
P50.090.950	1	Avis. Acústico PRO-MULTI-ALARM Carcasa: Kunststoff Conexión: 0,4m open end Voltaje: 10-80 Volt Protección: IP67 Homolog.: EMV Potencia: 97dBA Función: Pitido, sonido limpio, función silencio Back Alar. Syst. PRO-MULTI-ALARM Housing: Plastic Cable: 0,4m open end Voltage: 10-80 Volt Protection: IP67 Homologation: EMC approved Power: 97dBA Function: Beep sound, white sound, silent function		Especificaciones Técnicas Specification - 12-80V - 87 dBA - -40° bis +85° - A prueba de agua - 300 gr. - 102x71x41mm

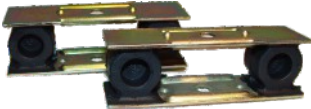
Accesorios

Accessories

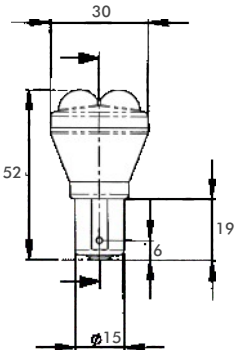
Referencia Reference-No.	Ud QTY	Descripción Description	Amortiguador/Shock Absorber Desconectador Bateria/Switch Isolator Modulo LED /LED Module	
P50.015.000	1	<p>Kit 2 amortiguadores para pilotos traseros</p> <p>Shock Absorber-Kit for rear lamps, includes 2 flex. Fixation units</p>		
P50.017.000	1	<p>Desconectador bateria de vehículo pesado, con palanca y 2 pernos para fijación Potencia Máxima: 2500 A en 24V (10 seg.)</p> <p>Switch, Isolator Heavy Duty</p> <p>Current rating, switching load: 2500 A on 24V (10 sec.)</p>		
P50.018.000	1	<p>Desconectador bateria de vehículo ligero, con llave y 2 pernos para fijación: Potencia Máxima: 1000 A en 12V (10 seg.) 500 A en 24V (10 seg.)</p> <p>Switch, Isolator Light Duty</p> <p>Current rating, switching load: 1000 A on 12V (10 sec.) 500 A on 24V (10 sec.)</p>		
P40.199.002	10	<p>Modulo LED "glowpoint" casquillo BA 15s. Homologado para muchos pilotos Proplast, Sustituye a la lámpara 5W BA 15s. Vida aproximada 10000 horas 24V - 28V</p> <p>LED Module "glowpoint" with BA 15s base. Replacement for bulb 5W BA 15s. Approved for many Proplast Rear Lamps. 24V-28V Life expectancy: over 10.000H</p>	 	

10

Cajas de conexión
Avisadores acústicos

Junction Boxes
Back Alarm Systems

10.0
10.1

ERGÄNZUNG 2021
SUPPLEMENT 2021



Accesorios / Cajas de conexión

Accessories / Junction Box

Tipo: PRO-LINK

Referencia: Reference-No.	Ud. QTY	Descripción Description	Pilotos Posición LED LED Position Lamps	Esquema Drawing
P50.052.500	1	<p>Caja de conexión PRO-LINK Cables y códigos numéricos acorde con la normativa ISO12098 Carcasa: ABS Entradas: 14 PG Conexión: 6,3mm AMP faston</p> <p><i>Junction Box PRO-LINK Cables and numbers according to ISO 12098 Housing: ABS Entrance: 14 PG-Screws Connection: 6,3mm AMP faston</i></p>	